

2023

aromas

COFER   STUD  

EST. 1993

COLLECTION



The speed of lights

From Aromas, we travel with the speed of our lights to hundreds of countries, places and projects, getting to know their cultures, projects and illusions. It is a pleasure to collaborate with all of you to make aromas a real project every day.

Desde Aromas, viajamos con la velocidad de nuestras luces a cientos de países, lugares y proyectos, conociendo sus culturas, proyectos e ilusiones. Es un placer colaborar con todos vosotros para hacer de aromas un proyecto real cada día.

In Aromas del Campo we began our journey as a company in 1986, in Valencia. At that time our specialty was the manufacturing of potpourris of dried flowers and aromatic products. A few years later we started to make small glass table lamps filled with dried flowers. Since then, and once consolidated in the lighting sector, we moved our activity to the town of Bétera (Valencia), where we centralized production and international distribution of our lighting products.

We bet on technological design, functional and affordable lamps, with pure and simple lines but without neglecting the forms of Aromas. In this collection we focus on traditionally relegated materials to the construction finishes and decorative complements, such as marble, wood or ceramic. However, our main materials continue to be metal and glass, combined in a diversion of solidity and lightness that results in elegant and timeless pieces.

En Aromas del Campo comenzamos nuestra andadura como sociedad en 1986, en Valencia. En aquellos entonces nuestra especialidad era la fabricación de potpourris de flores secas y productos aromáticos. Unos años más tarde comenzamos a fabricar pequeños sobremesas de cristal rellenos de flores secas. Desde entonces, y una vez consolidados en el sector de la iluminación, trasladamos nuestra actividad a la población de Bétera (Valencia), desde donde centralizamos la producción y distribución internacional de nuestros productos de iluminación.

Apostamos por un diseño tecnológico, funcional y asequible, con líneas puras y sencillas pero sin descuidar la forma. En esta colección ponemos el foco en materiales tradicionalmente relegados a los acabados constructivos y a los complementos de la decoración, como son el mármol, la madera o la cerámica. Sin embargo, nuestros materiales principales continúan siendo el metal y el cristal combinados en un juego de solidez y ligereza que resulta en piezas elegantes y atemporales.

INDEX

- 02 **Table lamps**
Lámparas de sobremesa · 6
- 03 **Pendant Lamps**
Lámparas colgantes · 106
- 04 **Floor Lamps**
Lámparas de pie · 262
- 05 **Wall Lamps**
Appliques · 304
- 06 **Accessories**
Accesorios · 412
- 07 **Bulbs**
Bombillas · 418
- 08 **Finishes**
Acabados · 426
- 09 **General Information**
Información General · 430



Table

Lamps

8	TURA · S1313	56	DAMO · S1191
10	DOUL · S1310	58	BOA · S1193
12	TANA · S1309	59	LALU · S1189
14	DUSSA · S1307	60	MILA · S1183
16	BION · S1306	62	HEDRA · S1159
18	BALLY · S1305	63	STAN · S1154
20	FILA · S1304	64	ENDO · S1156
21	ICONIC · S1300	66	HEDULA · S1150
22	YCRO · S1297	67	SAND · S1109
24	ISON · S1298	68	ALDA · S1108
25	NANO · S1294	70	CAND · S1107
26	PIPE · S1293	72	ONA · S1029
27	PORTA · S1290	73	TEX · S1026
28	PORTA-L · S1290/L	74	ONUT · NAC130
29	AMBOR · S1283	76	BORA · NAC129
30	KINE · S1288	78	TILLA · NAC128
31	FITO · S1286	80	DAB · NAC127
32	ATIL · S1281	82	BABEL · NAC126
33	FOCUS · S1279	83	GOT · NAC125
34	NOOI · S1276	84	COPO · NAC124
36	NINO · S1275	85	AGRA · NAC123
37	LYB · S1274	86	ENA · NAC121
38	AITO · S1270	88	ADON · NAC119
39	SHIN · S1261	89	HOME · NAC118
40	ABBACUS · S1258	90	METRIC · NAC117
41	ERTO · S1257	91	SONICA · NAC116 · NAC114
42	MAHO · S1254	94	ATINA · NAC115
44	FICUS · S1243	95	TARO · NAC113
45	ALOA · S1240 · S1227	96	SHADOW · NAC112
46	LUCA · S1237	97	NOA · NAC110
47	LOLA · S1232	98	PONN PONN · NAC109
48	NERA · S1229	100	KITTA KITTA · NAC108
50	LITA · S1230	101	KITTA PONN · NAC107
51	LIND · S1220 · S1220/USB	102	PONN · NAC106
52	ATOM · S1214	103	LUSA · NAC104
53	DOBI · S1207	104	MELLY · NAC103
54	COHEN · S1196	105	SAM · NAC093
55	MARU · S1194		



TURA 476€ (+IVA)

S1313
Designed b JF Sevilla, 2023

DESCRIPTION

MATERIALS
Steel / Leather / Marble

FINISHES
Steel:
Matt black
Leather:
Black / Brown / Orange
Marble:
Matt Black

SPECIFICATIONS
Chip LED 5W 2700K, Dimmable
Dimmer on cable
24V - 50/60 Hz
IP20 - Class II

ENERGY LABEL
A ++

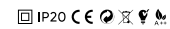

MATERIALES
Metal / Cuero / Mármol

ACABADOS
Metal:
Negro mate
Cuero:
Negro / Marrón / Naranja
Mármol:
Negro mate

ESPECIFICACIONES
Chip LED 5W 2700K, Regulable
Regulador en cable
24V, 50/60 Hz
IP20, Clase II

ETIQUETA ENERGÉTICA
A ++

TECHNICAL

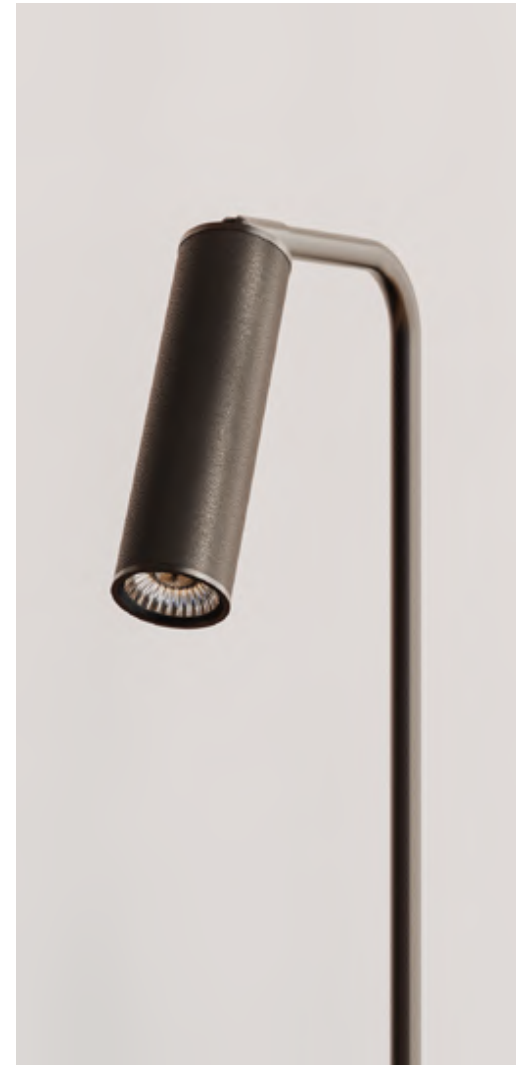
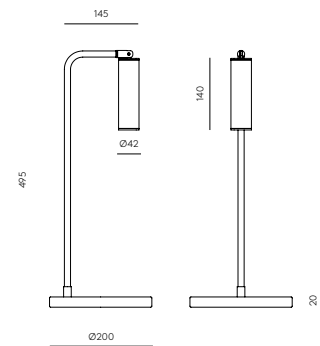

DOUL 343€ (+IVA)

S1310

Designed by Agus Gascón, 2023

DESCRIPTION

MATERIALS

Steel / Glass

FINISHES

Body: Matt black / Aged gold

Glass: Striped glass - Transparent

SPECIFICATIONS (UE)

G4 LEDs 3W 2700K

Dimmable (Included)

Regulation on cable

220-240V, 50/60Hz

IP20, Class II

ENERGY LABEL

A ++

MATERIALES

Metal / Vidrio

ACABADOS

Cuerpo: Negro mate / Oro envejecido

Cristal: Cristal rayado - Transparente

ESPECIFICACIONES (UE)

G4 LED 3W 2700K

Regulable (Incluida)

Regulación en cable

220-240 V, 50/60 Hz

IP20, Clase II

ETIQUETA ENERGÉTICA

A ++

IP20 CE RoHS

TECHNICAL

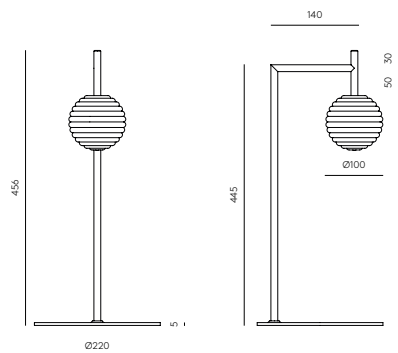

10





kyoto, japan

TANA 251€ (+IVA)

S1309

Designed by JF Sevilla, 2022

DESCRIPTION

MATERIALS

Steel

FINISHES

Steel:
Matt black

SPECIFICATIONS

Chip LED 4W - 2700K
(included)
Dimmer on cable
220-240V - 24V - 50/60 Hz
IP20 - Class I

ENERGY LABEL

A ++

MATERIALES

Metal

ACABADOS

Metal:
Negro mate

ESPECIFICACIONES

Chip LED 4W - 2700K (Incluida)
Regulador en cable
220-240V - 24V - 50/60 Hz
IP20 - Clase I

ETIQUETA ENERGÉTICA

A ++

IP20    

TECHNICAL

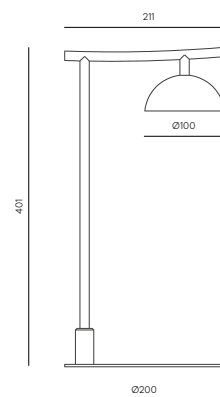

DUSSA 431€ (+IVA)

Table lamp

S1307

Designed by Pepe Fornas, 2022

DESCRIPTION

MATERIALS
Steel / Marble

FINISHES
Steel:
Matt black
Aged gold

Marble:
Black
White
Travertine

SPECIFICATIONS
Led Plate 9W 2700K
Dimmer on cable
24 V, 50/60 Hz
IP20 - Class II

ENERGY LABEL
A ++

MATERIALES
Acero / Marmol

ACABADOS
Metal:
Negro mate
Oro envejecido

Marmol:
Negro
Blanco
Travertino

ESPECIFICACIONES
Placa LED 9W - 2700K
Regulador en cable
24 V, 50/60 Hz
IP20, Clase II

ETIQUETA ENERGETICA
A ++

IP20 CE RoHS WEEE

TECHNICAL

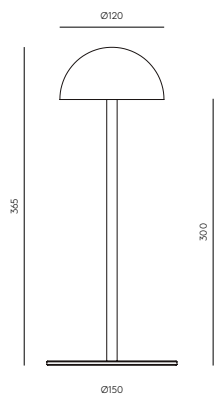

Sofia, Bulgaria

BION 478€ (+IVA)

Table lamp

S1306

Designed by Pepe Fornas, 2022

DESCRIPTION

MATERIALS
Steel /Marble

FINISHES
Body:
Matt black
Aged gold

Shade:
Matt black
Matt white

Base:
Matt black marble

SPECIFICATIONS
G9 LED 5W 2700K
Dimmable (Included)
Dimmer on cable
220-240 V, 50/60 Hz
IP20, Class II

ENERGY LABEL
A ++

IP20 CE RoHS

MATERIALES
Acero /Mármol

ACABADOS
Cuerpo:
Negro mate
Oro envejecido

Túlipa:
Negro mate
Blanco mate

Base:
Mármol negro mate

ESPECIFICACIONES
G9 LED 5W 2700K
Regulable (Incluida)
Regulación en cable
220-240 V, 50/60 Hz
IP20, Clase II

ETIQUETA ENERGÉTICA
A ++

TECHNICAL

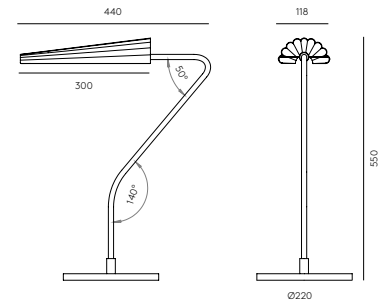

BALLY 324€ (+IVA)

Table lamp

S1305

Designed by AC Studio, 2022

DESCRIPTION

MATERIALS

Glass/ Steel /
Synthetic leather

FINISHES

Steel:
Matt black

Glass:
curly transparent

Synthetic leather:
Brown

SPECIFICATIONS

Dimmable Led Chip (Included)
5W, 3000K
5V/A 9600mAh battery
50/60Hz
IP20 - Class III
Touch me - Dimmable
Portable and rechargeable
Charger and cable included

ENERGY LABEL

A ++

IP20 CE RoHS RECYCLED

MATERIALES

Vidrio / Metal /
Cuero Sintético

ACABADOS

Metal:
Negro Mate

Vidrio:
Transparente rizado

Cuero Sintético:
Marrón

ESPECIFICACIONES

Chip Led regulable (Incluido)
5W, 3000K
5V/A Bateria 9600mAh
50/60 Hz
IP20 - Clase III
Touch me - Regulable
Portatil y recargable
Cargador y cable incluido

ETIQUETA ENERGÉTICA

A ++

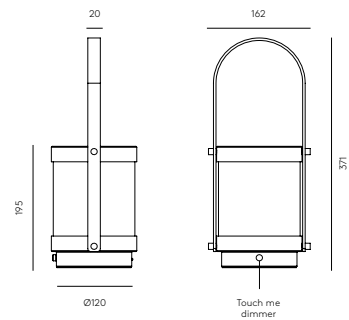

FILA 412€ (+IVA)

Table lamp

S1304

Designed by AC Studio, 2022

DESCRIPTION

MATERIALS

Steel

FINISHES

Base:
Matt black

Shade:
Matt brass
Matt white

Body:
Matt brass

SPECIFICATIONS (UE)

Portable lamp, Type C Charger
Led Max. 3W, 3000K, 300lm
Touch-me dimmer switch2
Core USB-C cord 1000mm
Lithium Battery 4800mAh
IP20 - Clase III

ENERGY LABEL

A ++

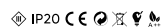

MATERIALES

Acero

ACABADOS

Base:
Negro Mate

Tulipa:
Oro mate
Blanco mate

Cuerpo:
Oro mate

ESPECIFICACIONES (UE)

Lámpara portátil, cargador tipo C
Led Max. 3W, 3000K, 300lm
Touch-me dimmer switch2
Cable Core USB-C 1000mm
Batería de litio 4800mAh
IP20 - Clase III

ETIQUETA ENERGÉTICA

A ++

TECHNICAL

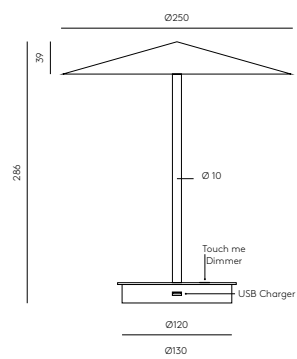

ICONIC 324€ (+IVA)

Table lamp

S1300

Designed by Agus Gascón, 2022

DESCRIPTION

MATERIALS

Steel / Marble

FINISHES

Metal:
Matt black
Matt Brass

Marble:
Finnish Marble

SPECIFICATIONS (UE)

COB Led 7W 2700K Dimmable
220-240V - 24V - 50/60 Hz
IP20 - Class II

ENERGY LABEL

A ++

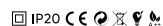

MATERIALES

Acero / Mármol

ACABADOS

Metal:
Negro Mate
Oro Mate

Mármol:
Finlandés

ESPECIFICACIONES (UE)

Placa Led 7W 2700K Regulable
220-240V - 24V - 50/60 Hz
IP20 - Clase II

ETIQUETA ENERGÉTICA

A ++

TECHNICAL

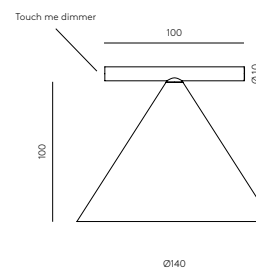

Brussels, Belgium



YCRO 280€ (+IVA)

Table lamp

S1297

Designed by JF Sevilla, 2022

DESCRIPTION

MATERIALS
Steel / Marble

FINISHES
Metal:
Matt black
Matt Brass
Marble:
Matt Black

SPECIFICATIONS (UE)
Chip Led 8W 3000K Dimmable
220-240V - 24V - 50/60 Hz
IP20 - Class II

ENERGY LABEL
A ++

IP20 CE ENEC

MATERIALES
Acero / Mármol

ACABADOS
Metal:
Negro Mate
Oro Mate
Mármol:
Negro Mate

ESPECIFICACIONES (UE)
Chip Led 8W 3000K Regulable
220-240V - 24V - 50/60 Hz
IP20 - Clase II

ETIQUETA ENERGÉTICA
A ++

TECHNICAL

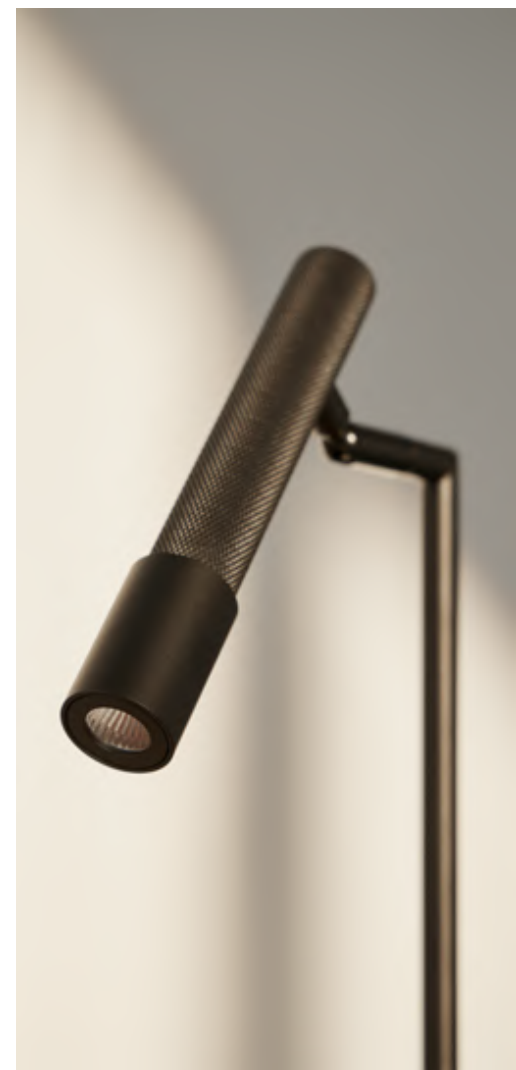
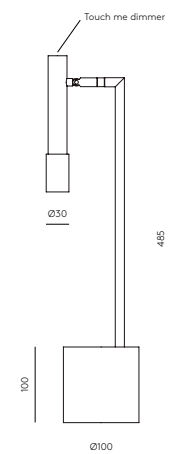

ISON 440€ (+IVA)

Table lamp

S1298

Designed by Pepe Fornas, 2022

DESCRIPTION

MATERIALS

Steel / Glass

FINISHES

Metal:

Aged Gold

Matt Black

Glass:

Fluted glass

SPECIFICATIONS (UE)

LED Strip 6W 2700K Dimmable

220-240V - 24V - 50/60 Hz

IP20 - Class II

ENERGY LABEL

A ++

IP20 CE RoHS REACH

MATERIALES

Acero / Vidrio

ACABADOS

Metal:

Oro envejecido

Negro Mate

Vidrio:

Estriado

ESPECIFICACIONES (UE)

Tira LED 6W 2700K Regulable

220-240V - 24V - 50/60 Hz

IP20 - Clase II

ETIQUETA ENERGÉTICA

A ++

TECHNICAL

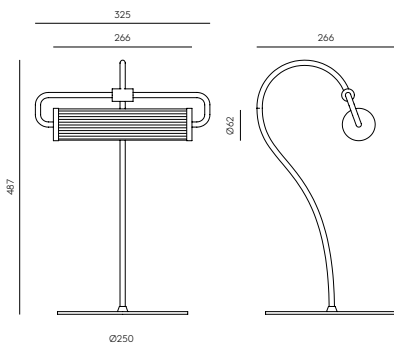

24



NANO 531€ (+IVA)

Table lamp

S1294

Designed by Agus Gascón, 2020

DESCRIPTION

MATERIALS

Steel / Marble / Glass

FINISHES

Metal:

Matt Brass

Marble:

Matt Black

Glass:

Opal

SPECIFICATIONS (UE)

COB LED 3W, 3000K

3,7V 2000 mAh 50/60 Hz

IP20, Class III

Touch me - Dimmable

Portable and rechargeable

Wireless charger and USB

included

ENERGY LABEL

A ++

IP20 CE RoHS REACH

MATERIALES

Acero / Mármol / Vidrio

ACABADOS

Metal:

Oro mate

Mármol:

Negro mate

Vidrio:

Opal

ESPECIFICACIONES (UE)

COB LED 3W, 3000K

3,7V 2000 mAh 50/60 Hz

IP20, Clase III

Touch me - Regulable

Portátil y recargable

Base de carga inalámbrica y usb

incluidos

ETIQUETA ENERGÉTICA

A ++

TECHNICAL

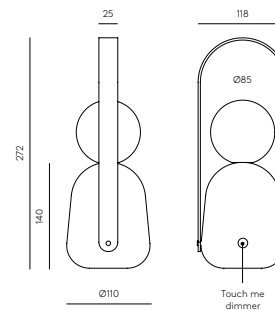

25



PIPE 305€ (+IVA)

Table lamp

S1293

Designed by AC Studio, 2021

DESCRIPTION

MATERIALS

Steel

FINISHES

Metal:
Matt Black

SPECIFICATIONS (UE)

GU10 LED 3W 3000K dimmable
220-240 V, 50/60 Hz
Dimmer switch on cable
IP20, Class II

ENERGY LABEL

A ++

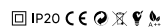

MATERIALES

Acero

ACABADOS

Metal:
Negro mate

ESPECIFICACIONES (UE)

GU10 LED 3W 3000K regulable
(incluida), 220-240 V, 50/60 Hz
Regulador en cable
IP20, Clase II

ETIQUETA ENERGÉTICA

A ++



TECHNICAL

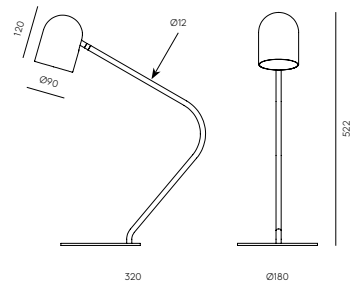

PORTA 401€ (+IVA)

Table lamp

S1290

Designed by Estudi Hac, 2021

DESCRIPTION

MATERIALS

Steel / Glass

FINISHES

Metal:
Matt Black

Glass:
Smoked grey

SPECIFICATIONS (UE)

9W LED Plate
2700K Dimmable
24 V, 50/60 Hz
IP20, Class II

ENERGY LABEL

A ++

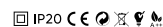

MATERIALES

Acero / Vidrio

ACABADOS

Metal:
Negro mate

Vidrio:
Gris ahumado

ESPECIFICACIONES (UE)

Placa LED 9W
2700K Regulable
24 V, 50/60 Hz
IP20, Clase II

ETIQUETA ENERGÉTICA

A ++



TECHNICAL

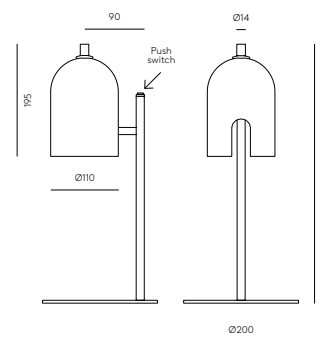

PORTA-L 354€ (+IVA)

Table lamp

S1290/L

Designed by Estudi Hac, 2021

DESCRIPTION

MATERIALS

Steel / Glass

FINISHES

Metal:
Matt Black

Glass:
Smoked grey

SPECIFICATIONS (UE)

9W LED Plate
2700K Dimmable
Dimmer switch on cable
24 V, 50/60 Hz
IP20, Class II

ENERGY LABEL

A ++

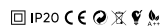

MATERIALES

Acero / Vidrio

ACABADOS

Metal:
Negro mate

Vidrio:
Gris ahumado

ESPECIFICACIONES (UE)

Placa LED 9W
2700K Regulable
Regulador en cable
24 V, 50/60 Hz
IP20, Clase II

ETIQUETA ENERGÉTICA

A ++

TECHNICAL

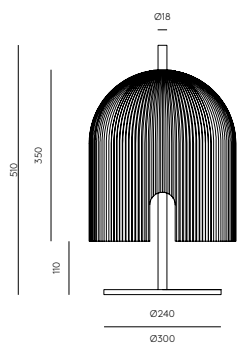

AMBOR 354€ (+IVA)

Table lamp

S1283

Designed by JF Sevilla, 2019

DESCRIPTION

MATERIALS

Steel

FINISHES

Body:
Matt Black

Base/Shade:
Matt Brass
Matt Black

BULBS INCLUDED

B005/3W/REG

SPECIFICATIONS (UE)

G9 Led Dimmable Bulbs
(incl.) 2 x 3W - 3000K
220-240 V, 50/60 Hz
IP20, Class II
Dimmer on cable

ENERGY LABEL

A ++

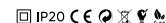

MATERIALES

Acero

ACABADOS

Cuerpo:
Negro mate

Base/Pantalla:
Oro mate
Negro mate

BOMBILLAS INCLUIDAS

B005/3W/REG

ESPECIFICACIONES (UE)

Bombillas G9 Led Regulables
(incl.) 2 x 3W - 3000K
220-240 V, 50/60 Hz
IP20, Clase II
Regulador en cable

ETIQUETA ENERGÉTICA

A ++

TECHNICAL

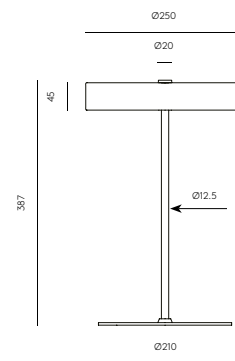

KINE

Blanco Mate / Negro Mate: 735€ (+IVA)
Oro Mate: 828€ (+IVA)

Table lamp

S1288

Designed by Pepe Fornas, 2020

DESCRIPTION

MATERIALS

Steel/Marble

FINISHES

Base:
Matt Black Marble
Matt White Marble

Shade:
Textured Black
Textured White
Matt Brass

SPECIFICATIONS (UE)

Integrated LED plate 10W
2700K 24V, 50 / 60Hz
IP20, Class II
Touch Me Dimmer

ENERGY LABEL

A ++

MATERIALES

Acero / Mármol

ACABADOS

Base:
Mármol negro mate
Mármol blanco mate

Tulipa:
Negro texturado
Blanco texturado
Oro mate

ESPECIFICACIONES (UE)

Placa LED integrada 10W
2700K 24V, 50/60Hz
IP20, Clase II
Touch Me Regulable

ETIQUETA ENERGÉTICA

A ++

IP20 CE E U F A++

TECHNICAL

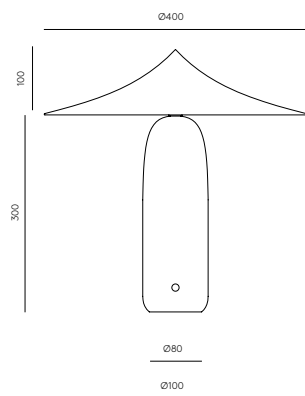

30



FITO

280€ (+IVA)

Table lamp

S1286

Designed by Pepe Fornas, 2020

DESCRIPTION

MATERIALS

Steel

FINISHES

Base: Matt Brass

Shade:
Matt Black
Matt White

OPTIONS

50 cm shade, ask for height

SPECIFICATIONS (UE)

E27 (Bulb not included)
220-240 V, 50/60 Hz
IP20, Class II
Dimmer on cable

ENERGY LABEL

A ++

MATERIALES

Acero

ACABADOS

Base: Oro Mate

Tulipa:
Blanco Mate
Negro Mate

OPCIONES

Pantalla 50 cm, altura consultar

ESPECIFICACIONES (UE)

E27 (Bombilla no incluida)
220-240 V, 50/60 Hz
IP20, Clase II
Regulador en cable

ETIQUETA ENERGÉTICA

A ++

IP20 CE E U F A++

TECHNICAL

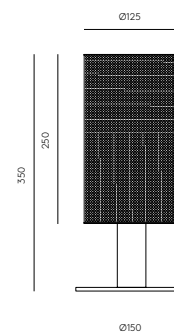

31



ATIL Negro Mate: 592€ (+IVA) Oro Mate: 658€ (+IVA)

Table lamp

S1281

Designed by Pepe Fornas, 2019

DESCRIPTION

MATERIALS

Steel

FINISHES

Metal:
Matt Black
Matt Brass

Glass:
Opal

SPECIFICATIONS (UE)

Bulbs G9 Led (Included)
2 x 5W - 2700K
220-240 V, 50/60 Hz
IP20, Class II

ENERGY LABEL

A ++

BULBS INCLUDED

B005/5W

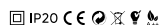

MATERIALES

Acero

ACABADOS

Metal:
Negro mate
Oro mate

Vidrio:
Opal

ESPECIFICACIONES (UE)

Bombillas G9 Led (Incluidas)
2 x 5W - 2700K
220-240 V, 50/60 Hz
IP20, Clase II

ETIQUETA ENERGÉTICA

A ++

BOMBILLAS INCLUIDAS

B005/5W

TECHNICAL

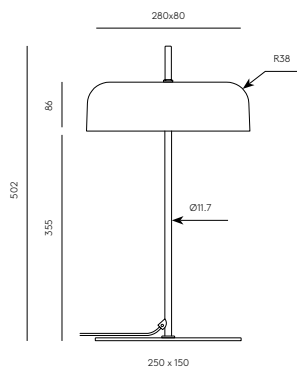

32

FOCUS Oro, Antracita, Negro Mate: 342€ (+IVA) Alabastro: 412€ (+IVA)

Table lamp

S1279

Designed by Pepe Fornas, 2019

DESCRIPTION

MATERIALS

Steel / Aluminium

FINISHES

Body:
Matt Black

Head:
Aged gold
Anthracite
Alabaster

POSSIBLE MODIFICATIONS

Alabaster head extra charge

SPECIFICATIONS (UE)

GU10 Led Bulb (Included)
5W - 2700K
220-240 V, 50/60 Hz
IP20, Class II

ENERGY LABEL

A ++

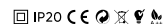

MATERIALES

Acero / Aluminium

ACABADOS

Cuerpo:
Negro mate

Cabezal:
Oro envejecido
Antracita
Alabastro

MODIFICACIONES POSIBLES

Cabezal de alabastro coste extra

ESPECIFICACIONES (UE)

Bombilla GU10 Led (Incluida)
5W - 2700K
220-240 V, 50/60 Hz
IP20, Clase II

ETIQUETA ENERGÉTICA

A ++

TECHNICAL

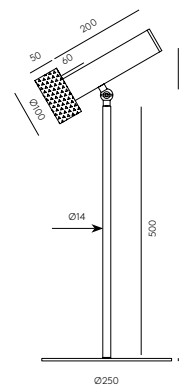

33

NOOI 305€ (+IVA)

S1276

Designed by Pepe Fornas, 2022

DESCRIPTION

MATERIALS

Linen / Steel / Acrylic

FINISHES

Metal:
Matt Black

Shade:
Cream Linen textile

Acrylic:
Opal

SPECIFICATIONS (UE)

T8 5W - 3000K
Dimmer on cable
220-240 V, 50/60 Hz
IP20, Class II

ENERGY LABEL

A ++

IP20 CE     

MATERIALES

Lino / Metal / Acrílico

ACABADOS

Metal:
Negro mate

Tulipa:
Textil Lino Crema

Acrílico:
Opal

ESPECIFICACIONES (UE)

T8 5W - 3000K
Regulador en cable
220-240 V, 50/60 Hz
IP20, Clase II

ETIQUETA ENERGÉTICA

A ++

TECHNICAL

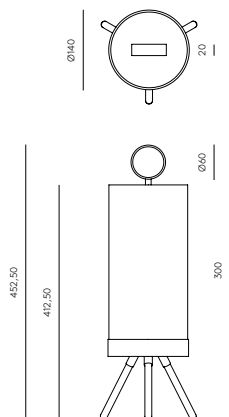

NINO 504€ (+IVA)

Table lamp

S1275

Designed by JF Sevilla, 2021

DESCRIPTION

MATERIALS

Steel / Marble / Glass

FINISHES

Metal:

Matt Black

Details:

Matt Brass

Marble:

Matt Black

Glass:

Optic

SPECIFICATIONS (UE)

LED 7W

2700K Dimmable

24 V, 50/60 Hz,

IP20, Class II

Touch me dimmer

ENERGY LABEL

A ++

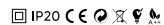

MATERIALES

Acero / Mármol / Vidrio

ACABADOS

Metal:

Negro mate

Detalles:

Oro mate

Mármol:

Matt Black

Vidrio:

Óptico

ESPECIFICACIONES (UE)

LED 7W

2700K Regulable

24 V, 50/60 Hz,

IP20, Clase II

Touch me dimmer

ETIQUETA ENERGÉTICA

A ++

TECHNICAL

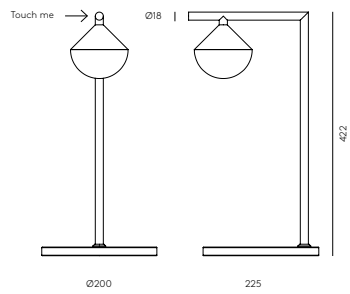

LYB 531€ (+IVA)

Table lamp

S1274

Designed by Pepe Fornas, 2019

DESCRIPTION

MATERIALS

Steel

FINISHES

Metal:

Matt Black

SPECIFICATIONS (UE)

Integrated LED chip 5W

3000K

12 V, 50/60 Hz

IP20, Class II

Touch me dimmer

ENERGY LABEL

A ++

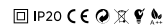

MATERIALES

Acero

ACABADOS

Metal:

Negro mate

ESPECIFICACIONES (UE)

Chip Led integrado 5W,

3000K

12 V, 50/60 Hz

IP20, Clase II

Touch me dimmer

ETIQUETA ENERGÉTICA

A ++

TECHNICAL

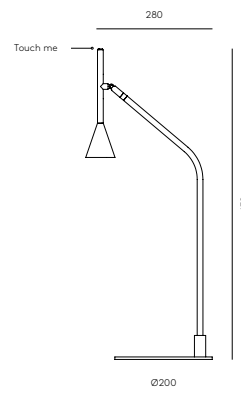

AITO 408€ (+IVA)

*Preguntar por stock

Table lamp

S1270

Designed by Pepe Fornas, 2019

DESCRIPTION

MATERIALS
Steel / Wood

MATERIALES
Acero / Madera

FINISHES

Metal:
Matt Black
Wood:
Walnut

ACABADOS

Metal:
Negro mate
Madera:
Nogal

SPECIFICATIONS (UE)

E27 Max. 60W (Not included)
220-240 V, 50/60 Hz
IP20, Class II

ESPECIFICACIONES (UE)

E27 Max. 60W (No incluida)
220-240 V, 50/60 Hz
IP20, Clase II

ENERGY LABEL

A ++

ETIQUETA ENERGÉTICA

A ++

BOMBILLA RECOMENDADA

B211 (7, 9, 11W)

RECOMMENDED BULB

B211 (7, 9, 11W)

IP20 CE ENEC RoHS LF

TECHNICAL

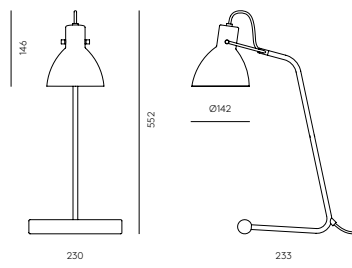

38



SHIN 596€ (+IVA)

Table lamp

S1261

Designed by Pepe Fornas, 2021

DESCRIPTION

MATERIALS
Steel / Marble

MATERIALES
Acero / Mármol

FINISHES

Marble black - Metal black
Marble white - Metal white
Shade not included
Recommended shade 801011/35

ACABADOS

Mármol negro - Metal negro
Mármol blanco - Metal blanco
Pantalla no incluida
Pantalla recomendada 801011/35

SPECIFICATIONS (UE)

E27, 5W LED Dimmable
2700k, (Included)
230V, 50/60 Hz
IP20, Class II
Touch me dimmer

ESPECIFICACIONES (UE)

E27, 5W LED Regulable
2700k, (Incluida)
230V, 50/60 Hz
IP20, Clase II
Touch Me Regulable

ENERGY LABEL

A ++

ETIQUETA ENERGÉTICA

A ++

IP20 CE ENEC RoHS LF

TECHNICAL

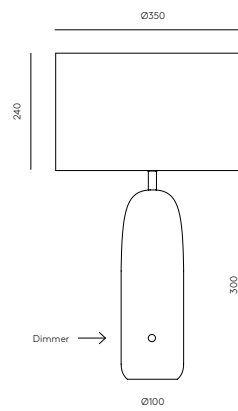

39



ABBACUS 601€ (+IVA)

Table lamp

S1258

Designed by Pepe Fornas, 2018

DESCRIPTION

MATERIALS

Steel / Blown Glass

FINISHES

Metal:

Matt Black

Matt Brass

Glass Shade (Included):

Opal/Clear

SPECIFICATIONS (UE)

Bulb G9, 5W - 2700K

220-240 V, 50/60 Hz

IP20, Class II

ENERGY LABEL

A ++

BULB INCLUDED

B005/5W

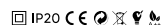

MATERIALES

Acero / Vidrio Soplado

ACABADOS

Metal:

Negro Mate

Oro Mate

Cristal (Incluido):

Opal/Transparente

ESPECIFICACIONES (UE)

Bombilla G9, 5W - 2700K

220-240 V, 50/60 Hz

IP20, Clase II

ETIQUETA ENERGÉTICA

A ++

BOMBILLA INCLUIDA

B005/5W

TECHNICAL

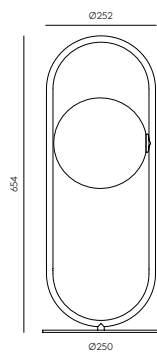

40

ERTO 555€ (+IVA)

Table lamp

S1257

Designed by Pepe Fornas, 2020

DESCRIPTION

MATERIALS

Steel

FINISHES

Metal:

Matt Black

Matt Brass (details)

COMPATIBLE ACCESSORIES

(Included in the price, choose one from below)

Alabaster - 1096/25

Glass - 1223

Ceramic - 1097/20

Metal - 1038/25

Stripped metal - 1089/25

SPECIFICATIONS (UE)

Bulb G9, 5W - 2700K

220-240 V, 50/60 Hz

IP20, Class II

ENERGY LABEL

A ++

BULB INCLUDED

B005/5W

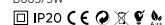

MATERIALES

Acero

ACABADOS

Metal:

Negro mate

Oro mate (detalles)

ACCESORIOS COMPATIBLES

(Incluido en el precio, elige uno de abajo)

Alabastro - 1096/25

Cristal - 1223

Cerámica - 1097/20

Metal - 1038/25

Metal rayado - 1089/25

ESPECIFICACIONES (UE)

Bombilla G9, 5W - 2700K

220-240 V, 50/60 Hz

IP20, Clase II

ETIQUETA ENERGÉTICA

A ++

BOMBILLA INCLUIDA

B005/5W

TECHNICAL

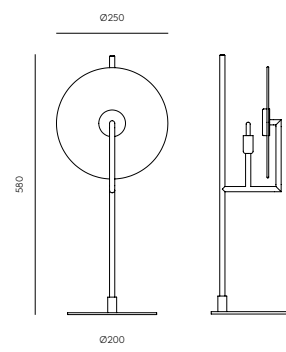

41

MAHO 324€ (+IVA)

S1254

Designed by JF Sevilla, 2020

DESCRIPTION

MATERIALS

Steel

FINISHES

Metal:
Black - Black
Black - Matt Brass

SPECIFICATIONS (UE)

Integrated LED chip 5W 3000K
24V, 50 / 60Hz
IP20, Class II
Touch Me Dimmer on head

ENERGY LABEL

A ++

MATERIALES

Acero

ACABADOS

Metal:
Negro - Negro
Negro - Oro Mate

ESPECIFICACIONES (UE)

Chip LED integrado 5W
3000K, 24V, 50/60Hz
IP20, Clase II
Touch Me Dimmer en cabeza

ETIQUETA ENERGÉTICA

A ++

IP20 CE   

TECHNICAL

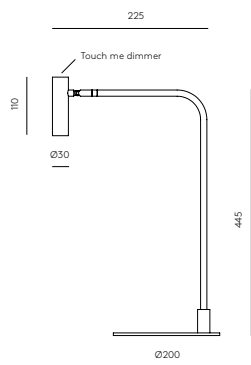

FICUS 492€ (+IVA)

Table lamp

S1243

Designed by JF Sevilla, 2017

DESCRIPTION

MATERIALS

Steel

FINISHES

Metal:
Matt Black
Matt Gold (Details)

Shade:
Matt Brass

SPECIFICATIONS (UE)

Bulb G9, 5W - 2700K
220-240 V, 50/60 Hz
IP20, Class II

ENERGY LABEL

A ++

BULB INCLUDED

B005/5W

IP20 CE ENEC RoHS LF

MATERIALES

Acero

ACABADOS

Metal:
Negro mate
Oro mate (detalles)

Tulipa:
Oro mate

ESPECIFICACIONES (UE)

Bombilla G9, 5W - 2700K
220-240 V, 50/60 Hz
IP20, Clase II

ETIQUETA ENERGÉTICA

A ++

BOMBILLA INCLUIDA

B005/5W



TECHNICAL

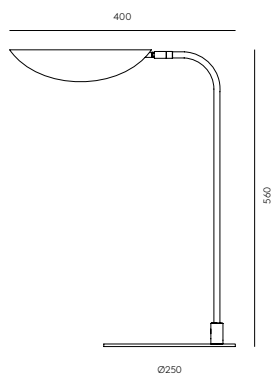

ALOA Negro Mate: 396€ (+IVA) Blanco Mate y Oro Mate: 455€ (+IVA)

Table lamp

S1240 - S1227

Designed by Fornasevi, 2017



DESCRIPTION

MATERIALS

Steel

FINISHES

S1227
Body: Matt black
Base/Shade: Matt black

S1240
Body: Matt brass
Base/Shade: Matt white

POSSIBLE MODIFICATIONS

See color palette

SPECIFICATIONS (UE)

E27 Max. 60W (Not included)
220-240 V, 50/60 Hz
IP20, Class II

ENERGY LABEL

A ++

IMAGE BULB

B038/GOLD (Not included)

IP20 CE ENEC RoHS LF

MATERIALES

Acero

ACABADOS

S1227
Cuerpo: Negro mate
Base/Pantalla: Negro mate

S1240
Cuerpo: Oro mate
Base/Pantalla: Blanco mate

MODIFICACIONES POSIBLES

Consultar paleta de colores

ESPECIFICACIONES (UE)

E27 Max. 60W (No incluida)
220-240 V, 50/60 Hz
IP20, Clase II

ETIQUETA ENERGÉTICA

A ++

BOMBILLA IMAGEN

B038/ORO (No incluida)

TECHNICAL

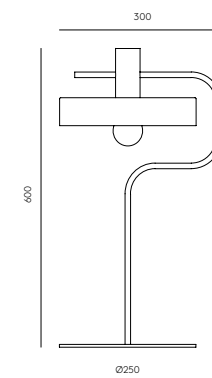

LUCA 399€ (+IVA)

Table lamp

S1237

Designed by AC Studio, 2017

DESCRIPTION

MATERIALS
Steel / Marble

FINISHES

Metal:
Matt Black
Marble:
White

SPECIFICATIONS (UE)



E27 Max. 60W (Not included)
220-240 V, 50/60 Hz
IP20, Class II

ENERGY LABEL

A ++

RECOMMENDED BULB

B211 (7, 9, 11W)

IP20 CE   

MATERIALES
Acero / Mármol

ACABADOS

Metal:
Negro Mate
Mármol:
Blanco

ESPECIFICACIONES (UE)

E27 Max. 60W (No incluida)
220-240 V, 50/60 Hz
IP20, Clase II

ETIQUETA ENERGÉTICA

A ++

BOMBILLA RECOMENDADA

B211 (7, 9, 11W)

TECHNICAL

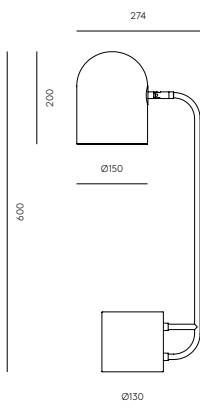

46



LOLA 259€ (+IVA)

Table lamp

S1232

Designed by AC Studio, 2017

DESCRIPTION

MATERIALS
Steel / Concrete

FINISHES

Metal:
Matt Black
Concrete:
Grey

SPECIFICATIONS (UE)

E14 Max. 40W (Not included)
220-240 V, 50/60 Hz
IP20, Class II
Dimmer on concrete base

ENERGY LABEL

A ++

RECOMMENDED BULB

B116-2/REG

IP20 CE   

MATERIALES
Acero / Hormigón

ACABADOS

Metal:
Negro Mate
Hormigón:
Gris

ESPECIFICACIONES (UE)

E14 Max. 40W (No incluida)
220-240 V, 50/60 Hz
IP20, Clase II
Regulador en base

ETIQUETA ENERGÉTICA

A ++

BOMBILLA RECOMENDADA

B116-2/REG

TECHNICAL

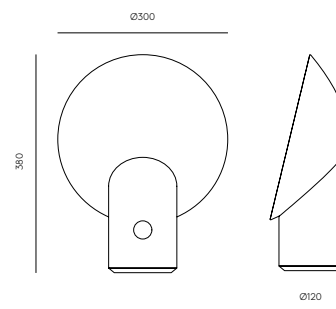

47

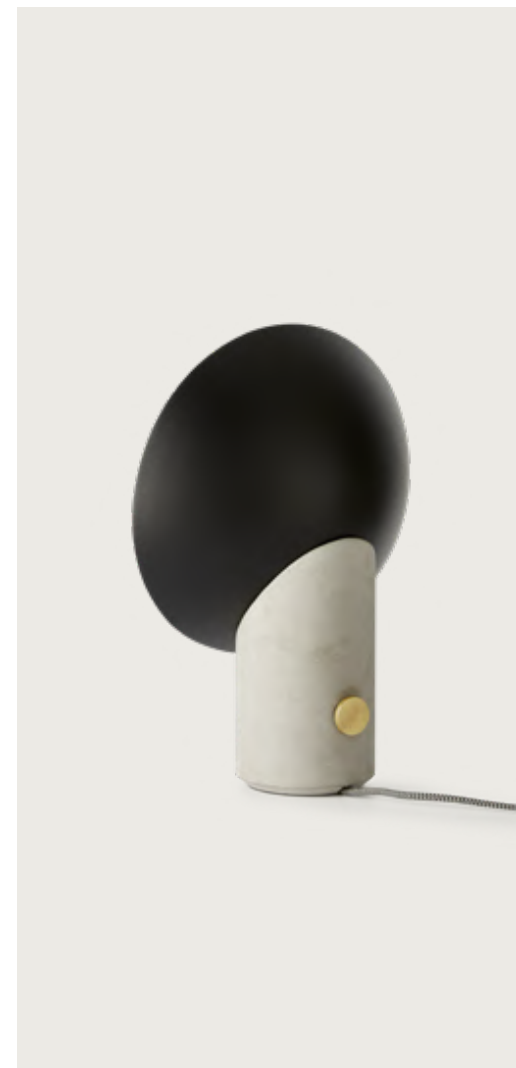

NERA 380€ (+IVA)

Table lamp

S1229

Designed by Pepe Fornas, 2020

DESCRIPTION

MATERIALS
Steel / Acrylic

FINISHES
Metal:
Matt black

SPECIFICATIONS (UE)
LED COB integrated 8W
3000K (Included)
12V / 220-240 V, 50/60 Hz
Touch me dimmer on head

ENERGY LABEL
A ++

IP20 CE RoHS RECYCLED

MATERIALES
Acero / Acrílico

ACABADOS
Metal:
Negro Mate

ESPECIFICACIONES (UE)
COB LED integrado 8W
3000K (Incluida)
12V / 220-240 V, 50/60 Hz
Touch me - Regulable en cabezal

ETIQUETA ENERGÉTICA
A ++

TECHNICAL

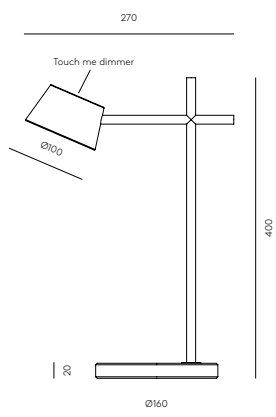

LITA

Nogal: 377€ (+IVA)
Negro Mate: 385€ (+IVA)

Table lamp

S1230

Designed by AC Studio, 2020

DESCRIPTION

MATERIALS

Steel / Wood

FINISHES

Metal:
Matt Black

Wood:
Matt Black
Walnut

SPECIFICATIONS (UE)

COB LED integrated 3W 3000K
(Included) Dimmable
Dimmer switch on cable
220-240 V, 50/60 Hz

ENERGY LABEL

A ++

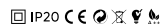

MATERIALES

Acero / Madera nogal

ACABADOS

Metal:
Negro Mate

Madera:
Negro Mate
Nogal

ESPECIFICACIONES (UE)

COB LED integrado 3W
3000K (Incluida) Regulable
Regulador en cable
220-240 V, 50/60 Hz

ETIQUETA ENERGÉTICA

A ++

TECHNICAL

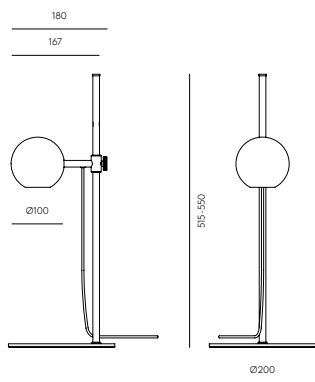

LIND

Cable (Oro Mate): 280€ (+IVA)
USB (Oro Mate): 377€ (+IVA)
USB (Negro Mate): 324€ (+IVA)

Table lamp

S1220 - S1220/USB

Designed by Agus Gascón, 2020

DESCRIPTION

MATERIALS

Steel / Alabaster

FINISHES

Metal:
Matt Brass (cable & USB)
Matt Black (USB)

Shade:
Alabaster

SPECIFICATIONS (UE) CABLE

Bulb G9 Led (Included)
5W - 3000K
220-240 V, 50/60 Hz
IP20, Class II

SPECIFICATIONS (UE) PORTABLE

LED COB integrated 3W 3000K
(Included) 4,2 V, 1A, 50/60 Hz
Touch me - Dimmable
Portable and rechargeable
USB charger included

ENERGY LABEL

A ++

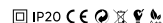

MATERIALES

Acero / Alabastro

ACABADOS

Metal:
Negro mate (cable & USB)
Blanco mate (USB)

Túlipa:
Alabastro

ESPECIFICACIONES (UE) CABLE

Bombilla G9 Led (Incluida)
5W - 3000K
220-240 V, 50/60 Hz
IP20, Clase II

ESPECIFICACIONES (UE) PORTÁTIL

COB LED integrado 3W 3000K
(Incluida) 4,2 V, 1A, 50/60 Hz
Touch me - Regulable
Portátil y recargable
Cargador USB incluido

ETIQUETA ENERGÉTICA

A ++

TECHNICAL

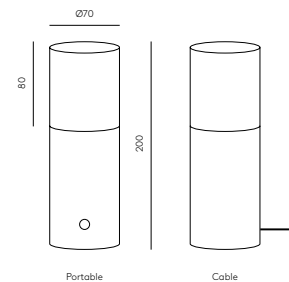

ATOM

Negro Mate: 392€ (+IVA)
Oro Mate: 489€ (+IVA)

Table lamp

S1214

Designed by AC Studio, 2017

DESCRIPTION

MATERIALS

Steel / Blown Glass

FINISHES

Metal:
Matt Black
Matt Brass

Glass Shade (Included):
Opal/Clear

SPECIFICATIONS (UE)

Bulb G9 (Included)
5W - 2700K
220-240 V, 50/60 Hz
IP20, Class II

ENERGY LABEL

A ++

BULB INCLUDED

B005/5W

IP20 CE ENEC RoHS A++

MATERIALES

Acero / Acrílico

ACABADOS

Metal:
Negro Mate
Oro Mate

Cristal (Incluido):
Opal/Transparente

ESPECIFICACIONES (UE)

Bombilla G9 (Incluida)
5W - 2700K
220-240 V, 50/60 Hz
IP20, Clase II

ETIQUETA ENERGÉTICA

A ++

BOMBILLA INCLUIDA

B005/5W

TECHNICAL

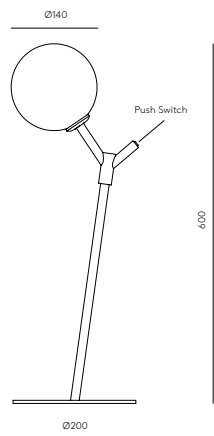

52

DOBI

328€ (+IVA)

Table lamp

S1207

Designed by AC Studio, 2015

DESCRIPTION

MATERIALS

Steel

FINISHES

Metal:
Matt Black

SPECIFICATIONS (UE)

E14 Max. 33W (Not included)
220-240 V, 50/60 Hz
IP20, Class II

ENERGY LABEL

A ++

RECOMMENDED BULB

B116-2 (5W)

IP20 CE ENEC RoHS A++

MATERIALES

Acero

ACABADOS

Metal:
Negro mate

ESPECIFICACIONES (UE)

E14 Max. 33W (No incluida)
220-240 V, 50/60 Hz
IP20, Clase II

ETIQUETA ENERGÉTICA

A ++

BOMBILLA RECOMENDADA

B116-2 (5W)

TECHNICAL

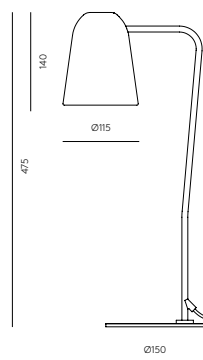

53

COHEN 408€ (+IVA)

Table lamp

S1196

Designed by Jana Chang, 2012

DESCRIPTION

MATERIALS

Steel

FINISHES

Metal: Matt Brass

Shade: Black, Shiny White

SPECIFICATIONS (UE)

E27 Max. 60W (Not included)
220-240 V, 50/60 Hz
IP20, Class II

ENERGY LABEL

A ++

RECOMMENDED BULB

B211 (7, 9, 11W)

MATERIALES

Acero

ACABADOS

Metal: Oro Mate

Tulipa: Negro, Blanco Brillo

ESPECIFICACIONES (UE)

E27 Max. 60W (No incluida)
220-240 V, 50/60 Hz
IP20, Clase II

ETIQUETA ENERGÉTICA

A ++

BOMBILLA RECOMENDADA

B211 (7, 9, 11W)

IP20 CE E U L

TECHNICAL

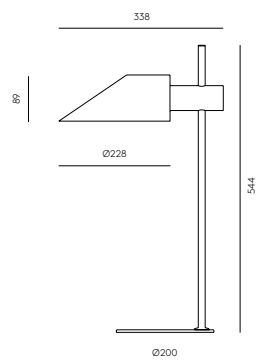

54



MARU Negro Mate - Oro Mate: 462€ (+IVA) Negro Mate - Negro Mate: 424€ (+IVA)

Table lamp

S1194

Designed by JF Sevilla, 2015

DESCRIPTION

MATERIALS

Steel

FINISHES

Matt Black - Matt Brass

Matt Black - Matt Black

SPECIFICATIONS (UE)

Integrated Led COB
3W - 3150K
12 V, 50/60 Hz
IP20, Class II

ENERGY LABEL

A ++

IP20 CE E U L

MATERIALES

Acero

ACABADOS

Metal:

Negro Mate - Oro Mate

Negro Mate - Negro Mate

ESPECIFICACIONES (UE)

Led COB integrado
3W - 3150K
12 V, 50/60 Hz
IP20, Clase II

ETIQUETA ENERGÉTICA

A ++

TECHNICAL

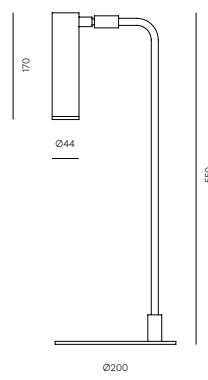

55

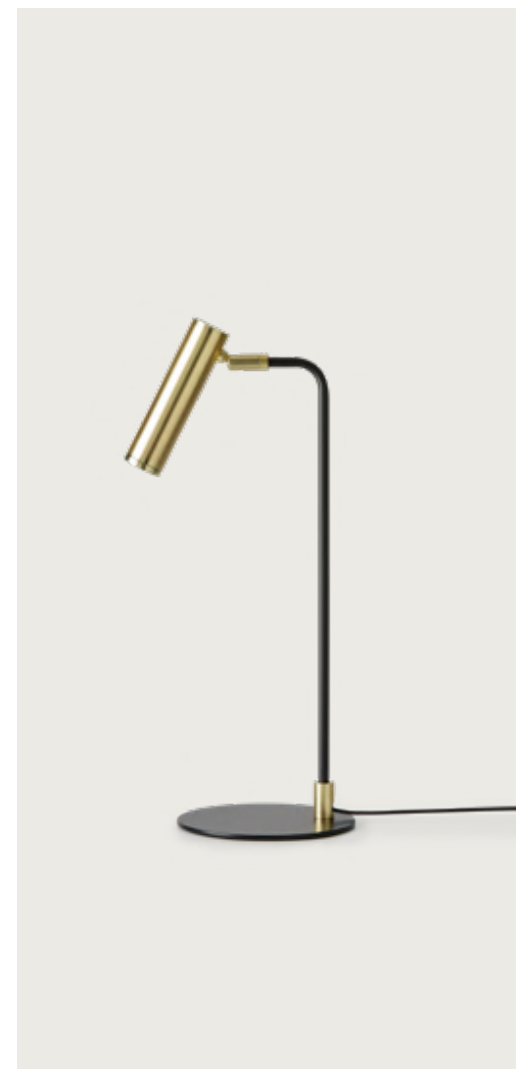

DAMO 693€ (+IVA)

S1191

Designed by AC Studio, 2015

DESCRIPTION

MATERIALS

Steel

FINISHES

Metal:
Matt Black

SPECIFICATIONS (UE)

E27 Max. 60W (Not included)
230 V, 50/60 Hz
IP20, Class II

ENERGY LABEL

A ++

RECOMMENDED BULB

B211 (7, 9, 11W)

MATERIALES

Acero

ACABADOS

Metal:
Negro mate

ESPECIFICACIONES (UE)





E27 Max. 60W (No incluida)
230 V, 50/60 Hz
IP20, Clase II

ETIQUETA ENERGÉTICA

A ++

BOMBILLA RECOMENDADA

B211 (7, 9, 11W)

IP20 CE    

TECHNICAL

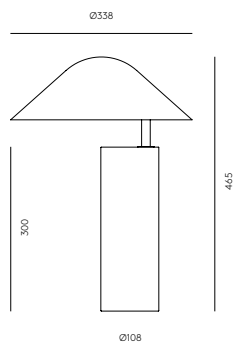

Rio de Janeiro, Brasil



BOA 427€ (+IVA)

Table lamp

S1193

Designed by Fornasevi, 2015

DESCRIPTION

MATERIALS

Steel

FINISHES

Body: Matt Black
Shade: Black, Matt Brass

SPECIFICATIONS (UE)

E27 Max. 60W (Not included)
220-240 V, 50/60 Hz
IP20, Class II

ENERGY LABEL

A ++

RECOMMENDED BULB

B211 (7, 9, 11W)

MATERIALES

Acero

ACABADOS

Cuerpo: Negro Mate
Tulipa: Negro, Oro Mate

ESPECIFICACIONES (UE)

E27 Max. 60W (No incluida)
220-240 V, 50/60 Hz
IP20, Clase II

ETIQUETA ENERGÉTICA

A ++

BOMBILLA RECOMENDADA

B211 (7, 9, 11W)

IP20 CE RoHS

TECHNICAL

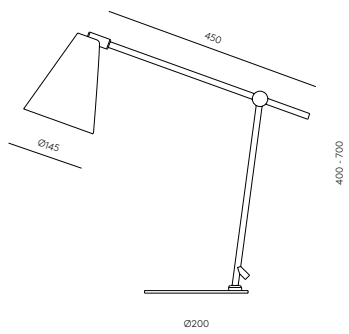

58



LALU Cromo: 489€ (+IVA) Oro Brillo: 555€ (+IVA)

Table lamp

S1189

Designed by Jana Chang, 2013

DESCRIPTION

MATERIALS

Steel

FINISHES

Metal: Chrome, Shiny brass
Shade: Shiny White
Image color: Green mole

POSSIBLE MODIFICATIONS

Color shade can be changed,
ask us about extracost.
Color palette on page

SPECIFICATIONS (UE)

E27 Max. 60W (Not included)
230 V, 50/60 Hz
IP20, Class II

ENERGY LABEL

A ++

RECOMMENDED BULB

B211 (7,9,11W)

IP20 CE RoHS

MATERIALES

Acero

ACABADOS

Metal: Cromo, Oro Brillo
Tulipa: Blanco brillo
Color en imagen: Verde mole

MODIFICACIONES POSIBLES

Para modificaciones en color de
pantalla consultar sobrecoste.
Paleta de colores en pág.

ESPECIFICACIONES (UE)

E27 Max. 60W (No incluida)
230 V, 50/60 Hz
IP20, Clase II

ETIQUETA ENERGÉTICA

A ++

BOMBILLAS RECOMENDADAS

B211 (7,9,11W)

TECHNICAL

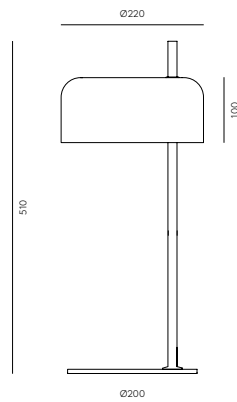

59



MILA 511€ (+IVA)

Table lamp

S1183

Designed by AC Studio, 2014

DESCRIPTION

MATERIALS

Steel / Fabric / Acrylic

FINISHES

Metal: Chrome, Matt Brass

Shade: White, Black

SPECIFICATIONS (UE)

E14 - 2 x Max. 40W

(Not included)

220-240 V, 50/60 Hz

IP20, Class II

ENERGY LABEL

A ++

RECOMMENDED BULB

B116-2 (5W)

MATERIALES

Acero / Pantalla Textil / Acrílico

ACABADOS

Metal: Cromo, Oro Mate

Pantalla: Blanco, Negro

ESPECIFICACIONES (UE)

E14 - 2 x Max. 40W

(No include)

220-240 V, 50/60 Hz

IP20, Clase II

ETIQUETA ENERGÉTICA

A ++

BOMBILLA RECOMENDADA

B116-2 (5W)

IP20 CE RoHS

TECHNICAL

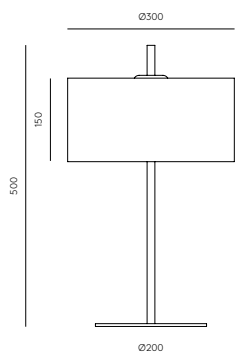

HEDRA 423€ (+IVA)

Table lamp

S1159

Designed by AC Studio, 2021

DESCRIPTION

MATERIALS
Steel / Marble

MATERIALES
Acero/ Mármol

FINISHES

Metal: Matt Black, Matt Brass

Marble: Matt black

Recommended shade:
801011/31 (Not included)

ACABADOS

Metal: Negro mate ,Oro mate

Mármol: Negro mate

Pantalla recomendada:
801011/31 (No incluida)

OTHER OPTIONS

Dome 1159 - 35cm Diameter

OTRAS OPCIONES:

Cupula 1159 - 35cm Diámetro

SPECIFICATIONS (UE)

E27LED regulable 9W 3000K
(included), 220-240 V, 50/60 Hz
IP20, Class II

ESPECIFICACIONES (UE)

E27LED regulable 9W 3000K
(incluida) 230V, 50/60 Hz
IP20, Clase II

ENERGY LABEL

A ++

ETIQUETA ENERGÉTICA

A ++

IP20 CE ENEC RoHS

TECHNICAL

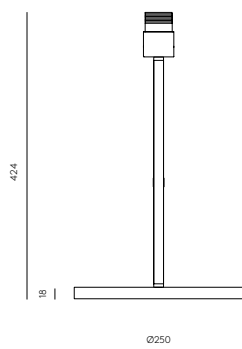

62



STAN 399€ (+IVA)

Table lamp

S1154

Designed by Fornasevi, 2018

DESCRIPTION

MATERIALS
Steel / Rattan

MATERIALES
Acero/ Ratán

FINISHES

Metal:
Matt Brass
Matt Black

Rattan:
Natural
Black

ACABADOS

Metal:
Oro Mate
Negro Mate

Ratán:
Natural
Negro

SPECIFICATIONS (UE)

E27 Max. 60W (Not included)
220-240 V, 50/60 Hz
IP20, Class II

ESPECIFICACIONES (UE)

E27 Max. 60W (No incluida)
220-240 V, 50/60 Hz
IP20, Clase II

ENERGY LABEL

A ++

ETIQUETA ENERGÉTICA

A ++

RECOMMENDED BULB

B033/COB

BOMBILLA RECOMENDADA

B033/COB

IP20 CE ENEC RoHS

TECHNICAL

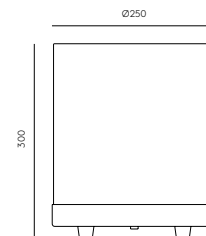

63



ENDO Cromo: 392€ (+IVA)
Oro Mate: 417€ (+IVA)

Table lamp

S1156

Designed by Pepe Fornas, 2013

DESCRIPTION

MATERIALS

Steel / Blown Glass

FINISHES

Metal: Matt Brass, Chrome

Shade (Included): Opal

SPECIFICATIONS (UE)

Bulb G9 Led - 5W (Included)

2700K

220-240 V, 50/60 Hz

IP20, Class II

ENERGY LABEL

A ++

RECOMMENDED BULB

B005/5W

MATERIALES

Acero/ Vidrio Soplado

ACABADOS

Metal: Oro Mate, Cromo

Tulipa (Incluida): Opal

ESPECIFICACIONES (UE)

Bombilla G9 Led - 5W (Incluida)

2700K

220-240 V, 50/60 Hz

IP20, Clase II

ETIQUETA ENERGÉTICA

A ++

BOMBILLA RECOMENDADA

B005/5W

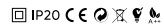

TECHNICAL

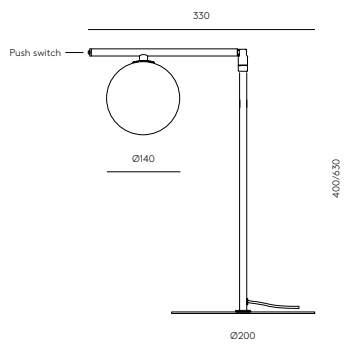

Zagreb, Croatia



HEDULA 265€ (+IVA)

*Preguntar por disponibilidad

Table lamp

S1150

Designed by AC Studio, 2020

DESCRIPTION

MATERIALS

Wood / Natural Fiber

FINISHES

Wood:

Black

Natural

Fiber:

Black

SPECIFICATIONS (UE)

E27 max. 60W (Not included)

220-240 V, 50/60 Hz

IP20, Class II

ENERGY LABEL

A ++

MATERIALES

Madera / Médula

ACABADOS

Madera:

Negro

Natural

Médula:

Negro

ESPECIFICACIONES (UE)

E27 max. 60W (No incluida)

220-240 V, 50/60 Hz

IP20, Clase II

ETIQUETA ENERGÉTICA

A ++



TECHNICAL

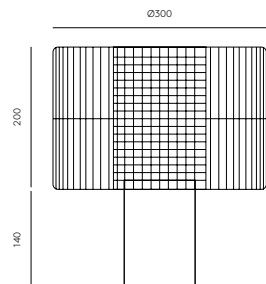

SAND 368€ (+IVA)

Table lamp

S1109

Designed by AC Studio, 2019

DESCRIPTION

MATERIALS

Terrazzo

FINISHES

Terrazzo: Grey

Shade included

SPECIFICATIONS (UE)

E27, 9W, 2700K

Dimmable (included)

Dimmer switch on base

220-240 V, 50/60 Hz

IP20, Class II

ENERGY LABEL

A ++

RECOMMENDED BULB

B211- 7/9/11W - Dimmable

MATERIALES

Terrazzo

ACABADOS

Terrazzo: Gris

Pantalla incluida

ESPECIFICACIONES (UE)

E27, 9W, 2700K

Regulable(incluida)

Regulador en la base

220-240 V, 50/60 Hz

IP20, Clase II

ETIQUETA ENERGÉTICA

A ++

BOMBILLA RECOMENDADA

B211- 7/9/11W - Regulable

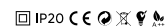

TECHNICAL

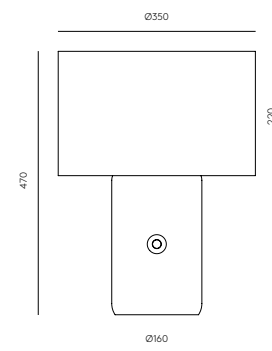

Tunis, Tunisia



ALDA 114€ (+IVA)

Table lamp

S1108

Designed by AC Studio, 2020

DESCRIPTION

MATERIALS

Steel / Wood / Marble

FINISHES

Metal: Matt black, Matt white
Matt brass, Shiny gold, Chrome

Wood: Black, Natural, Colour

Marble: Black, White,
Green, Brown

Image Shade:
801021/36 Not included

SPECIFICATIONS (UE)

E27 max. 60W (Not included)
220-240 V, 50/60 Hz
IP20, Class II

ENERGY LABEL

A ++

ASK FOR CUSTOMIZED
POSSIBILITIES



MATERIALES

Acero / Madera / Mármol

ACABADOS

Metal: Negro Mate, Blanco Mate
Oro Mate, Oro Brillo, Cromo

Madera: Natural, Negro, Color

Mármol: Negro, Blanco,
Verde, Marrón.

Pantalla de imagen:
801021/36 No incluida.

ESPECIFICACIONES (UE)

E27 max. 60W (No incluida)
220-240 V, 50/60 Hz
IP20, Clase II

ETIQUETA ENERGÉTICA

A ++

CONSULTAR POSIBILIDADES
DE CUSTOMIZACIÓN

TECHNICAL

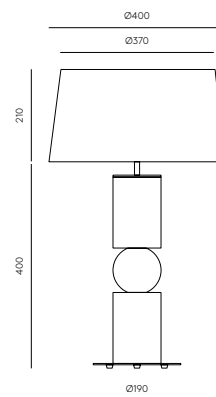

CAND 516€ (+IVA)

*Preguntar por disponibilidad

S1107

Designed by AC Studio, 2018

DESCRIPTION

MATERIALS

Steel/ Marble

FINISHES

Metal:

Aged Gold

Marble:

Black

POSSIBLE MODIFICATIONS

Image reference shade
801021/35. Shade not included.

SPECIFICATIONS (UE)

E27 Max. 60W (Not included)
220-240 V, 50/60 Hz, IP20,
Class II

ENERGY LABEL

A ++

RECOMMENDED BULB

B211 (7, 9, 11W)

MATERIALES

Acero / Mármol

ACABADOS

Metal:

Oro Envejecido

Mármol:

Negro

MODIFICACIONES POSIBLES

Pantalla imagen 801021/35
Pantalla no incluida.

ESPECIFICACIONES (UE)

E27 Max. 60W (No incluida)
220-240 V, 50/60 Hz, IP20,
Clase II

ETIQUETA ENERGÉTICA

A ++

BOMBILLA RECOMENDADA

B211 (7, 9, 11W)

IP20 CE RoHS

TECHNICAL

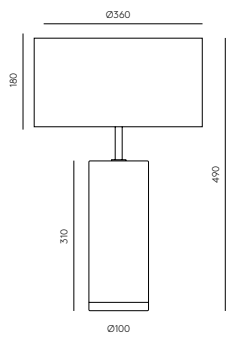

ONA 443€ (+IVA)

Table lamp

S1029

Designed by JI Ballester, 2008

DESCRIPTION

MATERIALS

Steel / Fabric / Acrylic

FINISHES

Metal: Nickel
Shade (included): White / Black

SPECIFICATIONS (UE)

E14 - 2 x Max. 40W
(Not included)
220-240 V, 50/60 Hz
IP20, Class II

ENERGY LABEL

A ++

RECOMMENDED BULB

B116-2 (5W)



MATERIALES

Acero / Pantalla Textil / Acrílico

ACABADOS

Metal: Níquel
Pantalla (incluida): Blanco / Negro

ESPECIFICACIONES (UE)

E14 - 2 x Max. 40W (No incluida)
220-240 V, 50/60 Hz
IP20, Clase II

ETIQUETA ENERGÉTICA

A ++

BOMBILLA RECOMENDADA

B116-2 (5W)

TECHNICAL

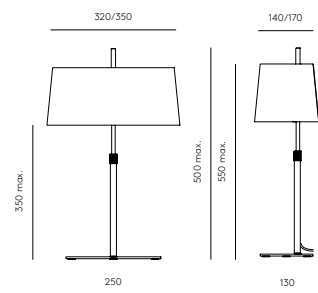

72



TEX 336€ (+IVA)

Table lamp

S1026

Designed by AC Studio, 2012

DESCRIPTION

MATERIALS

Steel

FINISHES

Metal:
Matt White
Matt Black

Image shade:
801021/36

SPECIFICATIONS (UE)

E27 Max. 60W (Not included)
220-240 V, 50/60 Hz
IP20, Class II

ENERGY LABEL

A ++

RECOMMENDED BULB

B211 (7, 9, 11W)

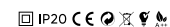

MATERIALES

Acero

ACABADOS

Metal:
Blanco Mate
Negro Mate

Pantalla de la imagen:
801021/36

ESPECIFICACIONES (UE)

E27 Max. 60W (No incluida)
220-240 V, 50/60 Hz
IP20, Clase II

ETIQUETA ENERGÉTICA

A ++

BOMBILLA RECOMENDADA

B211 (7, 9, 11W)

TECHNICAL

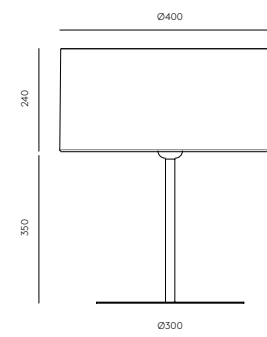

73



ONUT 530€ (+IVA)

*Base de 50 cm: 687€ (+IVA)

NAC130

Designed by AC Studio, 2023

DESCRIPTION

Materials
Metal / Ceramic

MATERIALES
Metal / Cerámica

FINISHES

Metal:
Matt black/ White
matt /Matt gold or glossy /Chrome
Ceramic (Hand-painted):
Consult color palette
Image colour:
Terracotta

ACABADOS

Metal:
Negro mate/ Blanco
mate /Oro mate o brillo /Cromo
Cerámica (Pintada a mano):
Consultar paleta de colores
Color de la imagen:
Terracotta

PICTURE SCREEN 801011/41
Not included

PANTALLA IMAGEN 801011/41
No incluida

SPECIFICATIONS (EU)
E27 Max. 60W LED (not included)
220-240V, 50/60Hz,
IP20, Class II

ESPECIFICACIONES (UE)
E27 Max. 60W LED (no incluida)
220-240 V, 50/60 Hz,
IP20, Clase II

DIMMER POSSIBILITY
B057 12W (Dimmable) + Dimmer
(extra cost to consult)

POSIBILIDAD REGULACIÓN
B057 12W (Regulable) + Regula-
dor (sobrecoste a consultar)

ENERGY LABEL
A++

ETIQUETA ENERGÉTICA
A++

IP20 CE RoHS WEEE

TECHNICAL

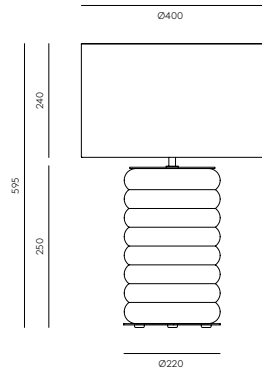

Luxembourg



Dublin, Ireland

BORA Metal: 368€ (+IVA)
Cerámica: 412€ (+IVA)

Table lamp

NAC129

Designed by AC Studio, 2022

DESCRIPTION

MATERIALS

Glass/ Steel or ceramics /
Synthetic leather

FINISHES

Steel:
Matt black
Aged gold

Ceramics:
See colour palette

Glass:
Curly transparent

Synthetic leather:
Brown

Image colours:
Left ceramic green leaf
Right metal matt black

SPECIFICATIONS

Led plate 3W 3000K (included)
5V/2A Battery 4800mAh
50/60 Hz IP65 - Class III
Touch me - Dimmable
Portable and rechargeable
Charger and cable included

ENERGY LABEL

A ++

IP20 CE RoHS REACH

MATERIALES

Vidrio / Metal o Cerámica /
Cuero Sintético

ACABADOS

Metal:
Negro Mate
Oro envejecido

Cerámica:
Consultar paleta de colores

Vidrio:
Transparente rizado

Cuero Sintético:
Marrón

Colores en imagen:
Izda. cerámica verde hoja
Dcha. metal negro mate

ESPECIFICACIONES

Placa Led 3W 3000K (incluido)
5V/2A Batería 4800mAh
50/60 Hz IP65 - Clase III
Touch me - Regulable
Portátil y recargable
Cargador y cable incluido

ETIQUETA ENERGÉTICA

A ++

TECHNICAL

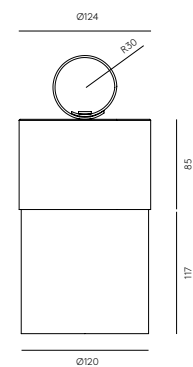

TILLA 586€ (+IVA)

Table lamp

NAC128

Designed by Agus Gascón, 2022

DESCRIPTION

MATERIALS

Steel / Glass

FINISHES

Steel:
Matt black
Matt white
Matt Brass
Bright gold
Chrome

Glass:

See colour palette

Image colours:

Left Silhouette
Right Petrol brlue

SPECIFICATIONS

E27 max. 60W Max.
(Not included)
220-240V, 50/60Hz
IP20, Class II
Shade (Not included)
Dimmer option

ENERGY LABEL

A ++

IP20 CE RoHS WEEE

MATERIALES

Acero / Vidrio

ACABADOS

Metal:
Negro Mate
Blanco Mate
Latón Mate
Oro Brillo
Cromo

Vidrio:

Ver paleta de colores

Colores en imagen:

Izquierda Silhouette
Derecha Azul sombrío

ESPECIFICACIONES

E27 max. 60W Max.
(No incluida)
220-240V, 50/60 Hz
IP20, Clase II
PANTALLA (No incluida)
Posibilidad regulación

ETIQUETA ENERGÉTICA

A ++

TECHNICAL

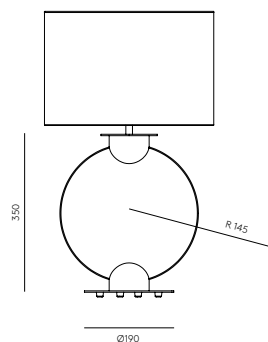

Auckland, New Zealand



DAB 467€ (+IVA)

Table lamp

NAC127
Designed by AC Studio, 2022

DESCRIPTION

MATERIALS
Steel /Ceramics

FINISHES

Steel:
Matt Brass
Matt black
Matt White

Ceramics hand painted:
See colour palette

Image colours:

Left Green mole
Right Terracotta

SPECIFICATIONS

E27 max. 60W Max.
(Not included)
220-240V, 50/60 Hz
IP20, Class II
Shade (Not included)
Dimmable option

ENERGY LABEL

A ++



MATERIALES
Acero /Cerámica

ACABADOS

Metal:
Oro mate
Negro mate
Blanco mate

Cerámica pintada a mano:
Consulta Paleta de colores

Colores en imagen:

Izda. Verde Mole
Dcha. Terracotta

ESPECIFICACIONES

E27 max. 60W Max.
(No incluida)
220-240V, 50/60 Hz
IP20, Clase II
Pantalla (No incluida)
Posibilidad regulación

ETIQUETA ENERGÉTICA

A ++

TECHNICAL

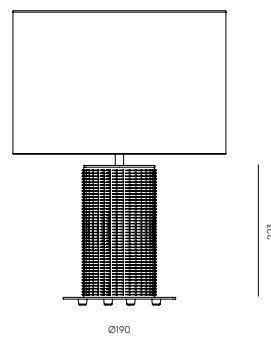

BABEL 574€ (+IVA)

Table lamp

NAC126

Designed by AC Studio, 2022

DESCRIPTION

MATERIALS

Steel / Ceramic

FINISHES

Metal: Matt black / Matt white
Matt Brass / Shiny Gold / Chrome

Ceramics (Hand Painted):
See colour palette.

Image color: Silhouette.

IMAGE SHADE 801011/41

Not included

SPECIFICATIONS (UE)

E27 max. 60W Max. (not included)
230V, 50/60 Hz, IP20, Class II

DIMMABLE OPTION

B211 11W (Dimmable) + Dimmer
(ask for extra cost)

ENERGY LABEL

A ++

MATERIALES

Acero / Cerámica

ACABADOS

Metal: Negro mate / Blanco
mate / Oro mate o brillo / Cromo

Cerámica (Pintada a mano):
Consultar paleta de colores

Color de la imagen: Silhouette.

PANTALLA IMAGEN 801011/41

No incluida

ESPECIFICACIONES (UE)

E27 max. 60W Max. (no incluida)
230V, 50/60 Hz, IP20, Clase II

POSIBILIDAD REGULACIÓN

B211 11W (Regulable) + Regulador
(sobrecoste a consultar)

ETIQUETA ENERGÉTICA

A ++

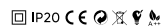

TECHNICAL

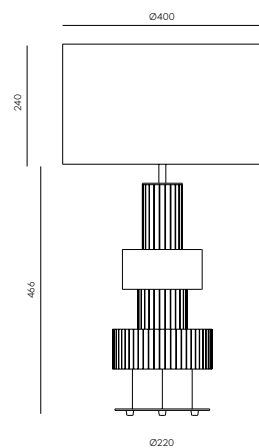

82



GOT 500€ (+IVA)

Table lamp

NAC125

Designed by AC Studio, 2022

DESCRIPTION

MATERIALS

Steel / Ceramic

FINISHES

Metal: Matt black / Matt white
Matt Brass / Shiny Gold / Chrome

Ceramics (Hand Painted):
See colour palette.

Image color: Pale Pink.

IMAGE SHADE 11532

Not included

SPECIFICATIONS (UE)

E27 max. 60W Max. (not included)
230V, 50/60 Hz, IP20, Class II

DIMMABLE OPTION

B211 11W (Dimmable) + Dimmer
(ask for extra cost)

ENERGY LABEL

A ++

MATERIALES

Acero / Cerámica

ACABADOS

Metal: Negro mate / Blanco
mate / Oro mate o brillo / Cromo

Cerámica (Pintada a mano):
Consultar paleta de colores

Color de la imagen: Rosa Palo.

PANTALLA IMAGEN 11532

No incluida

ESPECIFICACIONES (UE)

E27 max. 60W Max. (no incluida)
230V, 50/60 Hz, IP20, Clase II

POSIBILIDAD REGULACIÓN

B211 11W (Regulable) + Regulador
(sobrecoste a consultar)

ETIQUETA ENERGÉTICA

A ++

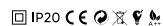

TECHNICAL

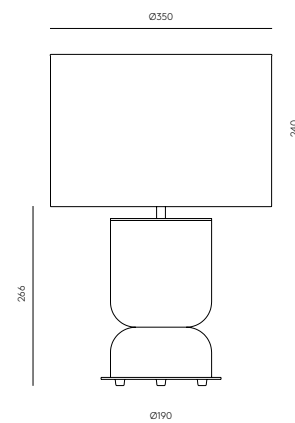

83



COPO 544€ (+IVA)

Table lamp

NAC124

Designed by Pepe Fornas, 2021

DESCRIPTION

MATERIALS

Steel / Ceramic

FINISHES

Metal: Matt black / Matt white
Matt Brass / Shiny Gold / Chrome

Ceramics (Hand Painted):

See colour palette.

Image color: Up: Mexico blue /
Down: green leaf

IMAGE SHADE 801011/46

Not included

SPECIFICATIONS (UE)

E27 max. 11W LED (not included)
230V, 50/60 Hz
IP20, Class II

DIMMABLE OPTION

B211 11W (Dimmable) + Dimmer
(ask for extra cost)

ENERGY LABEL

A ++

IP20 CE E U

MATERIALES

Acero / Cerámica

ACABADOS

Metal: Negro mate/ Blanco
mate /Oro mate o brillo/ Cromo

Cerámica (Pintada a mano):

Consultar paleta de colores

Color de la imagen: arriba: azul
mexico / abajo: verde hoja

PANTALLA IMAGEN 801011/46

No incluida

ESPECIFICACIONES (UE)

E27 max. 11W LED (no incluida)
230V, 50/60 Hz
IP20, Clase II

POSIBILIDAD REGULACIÓN

B211 11W (Regulable) + Regulador
(sobrecoste a consultar)

ETIQUETA ENERGÉTICA

A ++

TECHNICAL

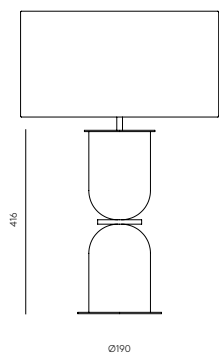

AGRA 544€ (+IVA)

Table lamp

NAC123

Designed by Pepe Fornas, 2021

DESCRIPTION

MATERIALS

Steel / Ceramic

FINISHES

Metal: Matt black / Matt white
Matt Brass / Shiny Gold / Chrome

Ceramics (Hand painted):

See colour palette

Image color:
Silhouette

IMAGE SHADE 801011/41

Not included

SPECIFICATIONS (UE)

E27 max. 11W LED (not incl)
230V, 50/60 Hz
IP20, Class II

DIMMABLE OPTION

B211 11W (Dimmable) + Dimmer
(ask for extra cost)

ENERGY LABEL

A ++

IP20 CE E U

MATERIALES

Acero / Cerámica

ACABADOS

Metal: Negro mate / Blanco
mate /Oro mate o brillo / Cromo

Cerámica (Pintada a mano):

Consultar paleta de colores

Color de la imagen:
Silhouette

PANTALLA IMAGEN 801011/41

No incluida

ESPECIFICACIONES (UE)

E27 max. 11W LED (no incluida)
230V, 50/60 Hz
IP20, Clase II

POSIBILIDAD REGULACIÓN

B211 11W (Regulable) + Regulador
(sobrecoste a consultar)

ETIQUETA ENERGÉTICA

A ++

TECHNICAL

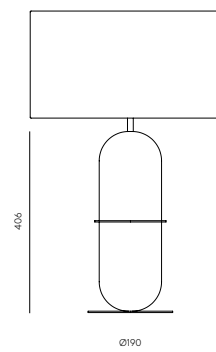

ENA 532€ (+IVA)

Table lamp

NAC121

Designed by AC Studio, 2020

DESCRIPTION

MATERIALS

Steel / Ceramic

FINISHES

Metal: Matt black / Matt white
Matt Brass / Shiny Gold / Chrome

Ceramics (Hand Painted):
See colour palette.

Image colours:

Left Banana green
Right Silhouette

IMAGE SHADE 801011/41

Not included

SPECIFICATIONS (UE)

E27 max. 60W (not included)
220-240 V, 50/60 Hz,
IP20, Class II

DIMMABLE OPTION

B211 11W (Dimmable) + Dimmer
(ask for extra cost)

ENERGY LABEL

A ++

IP20 CE RoHS REACH A++

MATERIALES

Acero / Cerámica

ACABADOS

Metal: Negro mate/ Blanco
mate / Oro mate o brillo/ Cromo

Cerámica (Pintada a mano):
Consultar paleta de colores

Color en imagen:

Izda. Banana green
Dcha. Silhouette

PANTALLA IMAGEN 801011/41

No incluida

ESPECIFICACIONES (UE)

E27 max. 60W (no incluida)
220-240 V, 50/60 Hz,
IP20, Clase II

POSIBILIDAD REGULACIÓN

B211 11W (Regulable) + Regulador
(sobrecoste a consultar)

ETIQUETA ENERGÉTICA

A ++

TECHNICAL

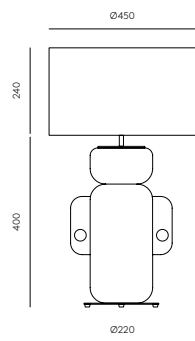

Lima, Peru

ADON 532€ (+IVA)

Table lamp

NAC119

Designed by AC Studio, 2020

DESCRIPTION

MATERIALS

Steel / Ceramic

FINISHES

Metal: Matt black / Matt white
Matt Brass / Shiny Gold / Chrome

Ceramics (Hand Painted):
See colour palette.

Image color: Terracotta

IMAGE SHADE 801021/41

Not included

SPECIFICATIONS (UE)

E27 Max. 60W (not included)
220-240 V, 50/60 Hz
IP20, Class II

DIMMABLE OPTION

B211 11W (Dimmable) + Dimmer
(ask for extra cost)

ENERGY LABEL

A ++

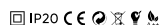

MATERIALES

Acero / Cerámica

ACABADOS

Metal: Negro mate/ Blanco mate / Oro mate o brillo/ Cromo

Cerámica (Pintada a mano):
Consultar paleta de colores

Color de la imagen: Terracotta

PANTALLA IMAGEN 801021/41

No incluida

ESPECIFICACIONES (UE)

E27 max. 60W (No incluida)
220-240 V, 50/60 Hz
IP20, Clase II

POSIBILIDAD REGULACIÓN

B211 11W (Regulable) + Regulador
(sobrecoste a consultar)

ETIQUETA ENERGÉTICA

A ++

TECHNICAL

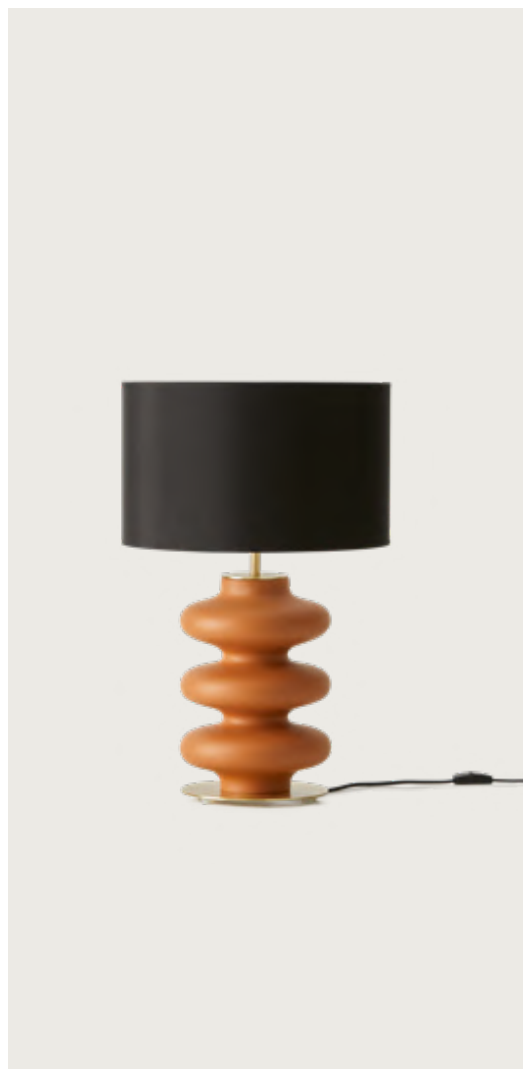
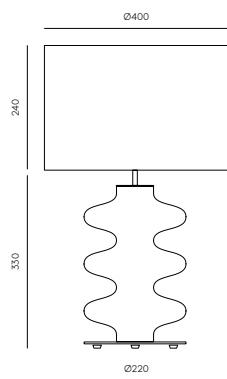

HOME 435€ (+IVA)

Table lamp

NAC118

Designed by Pepe Fornas, 2021

DESCRIPTION

MATERIALS

Steel / Ceramic

FINISHES

Metal: Matt black / Matt white
Matt Brass / Shiny Gold / Chrome

Ceramics (Hand Painted):
See colour palette.

Image color: Ash Grey

IMAGE SHADE 801011/40

Not included

SPECIFICATIONS (UE)

E27 Max. 60W LED (not included)
220-240 V, 50/60 Hz
IP20, Class II

DIMMABLE OPTION

B211 11W (Dimmable) + Dimmer
(ask for extra cost)

ENERGY LABEL

A ++

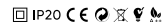

MATERIALES

Acero / Cerámica

ACABADOS

Metal: Negro mate/ Blanco mate / Oro mate o brillo/ Cromo

Cerámica (Pintada a mano):
Consultar paleta de colores

Color de la imagen: Gris Ceniza

PANTALLA IMAGEN 801011/40

No incluida

ESPECIFICACIONES (UE)

E27 Max. 60W LED (no incluida)
220-240 V, 50/60 Hz
IP20, Clase II

POSIBILIDAD REGULACIÓN

B211 11W (Regulable) + Regulador
(sobrecoste a consultar)

ETIQUETA ENERGÉTICA

A ++

TECHNICAL

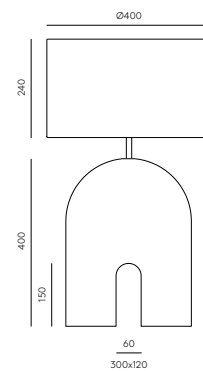

METRIC 554€ (+IVA)

Table lamp

NAC117
Designed by Pepe Fornas, 2019

DESCRIPTION

MATERIALS

Steel / Ceramic

FINISHES

Metal: Matt black / Matt white
Matt Brass / Shiny Gold / Chrome

Ceramics (Hand Painted):
See colour palette.

Image color: Silhouette

IMAGE SHADE 801011/41

Not included

SPECIFICATIONS (UE)

E27 Max. 60W LED (not included)
220-240 V, 50/60 Hz,
IP20, Class II

DIMMABLE OPTION

B211 11W (Dimmable) + Dimmer
(ask for extra cost)

ENERGY LABEL

A ++

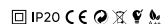

MATERIALES

Acero / Cerámica

ACABADOS

Metal: Negro mate/ Blanco mate / Oro mate o brillo / Cromo

Cerámica (Pintada a mano):
Consultar paleta de colores

Color de la imagen: Silhouette

PANTALLA IMAGEN 801011/41

No incluida

ESPECIFICACIONES (UE)

E27 Max. 60W LED (no incluida)
220-240 V, 50/60 Hz,
IP20, Clase II

POSIBILIDAD REGULACIÓN

B211 11W (Regulable) + Regulador
(sobrecoste a consultar)

ETIQUETA ENERGÉTICA

A ++

TECHNICAL

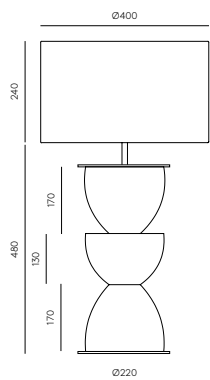

SONICA 30cm: 514€ (+IVA) 50cm: 540€ (+IVA)

Table lamp

NAC116 - NAC114
Designed by AC Studio, 2019

DESCRIPTION

MATERIALS

Steel / Ceramic

FINISHES

Metal: Matt black / Matt white
Matt Brass / Shiny Gold / Chrome

Ceramics (Hand Painted):
See colour palette.

Image colors:

Silhouette / Vintage brown
Next page Taupe/Green leaf

IMAGE SHADE (Not Included)

NAC116 801021/36,
NAC114 801011/35

SPECIFICATIONS (UE)

E27 Max. 60W LED (not included)
220-240 V, 50/60 Hz,
IP20, Class II

ENERGY LABEL

A ++

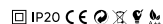

MATERIALES

Acero / Cerámica

ACABADOS

Metal: Negro mate/ Blanco mate / Oro mate o brillo / Cromo

Cerámica (Pintada a mano):
Consultar paleta de colores

Color de la imagen:

Silhouette / Marrón vintage
Siguiente pág. Topo / Verde hoja

PANTALLA IMAGEN (No incluido)

NAC116 801021/36,
NAC114 801011/35

ESPECIFICACIONES (UE)

E27 Max. 60W LED (no incluida)
220-240 V, 50/60 Hz,
IP20, Clase II

ETIQUETA ENERGÉTICA

A ++

TECHNICAL

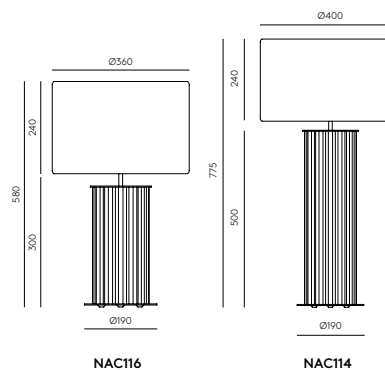



ATINA 537€ (+IVA)

Table lamp

NAC115

Designed by AC Studio, 2019

DESCRIPTION

MATERIALS

Steel / Glass

FINISHES

Metal: Matt black / Matt white
Matt Brass / Shiny Gold / Chrome

Glass (Hand Painted):

See colour palette.

Image color: Mexico Blue

IMAGE SHADE 801011/41

Not included

SPECIFICATIONS (UE)

E27 Max. 60W (Not included)
220-240 V, 50/60 Hz, IP20, Class II

ENERGY LABEL

A ++

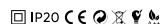

MATERIALES

Acero / Vidrio

ACABADOS

Metal: Negro mate/ Blanco mate/
Oro mate o brillo/ Cromo

Vidrio (Pintado a mano):

Consultar paleta de colores

Color de la imagen: Azul México

PANTALLA IMAGEN 801011/41

No incluida

ESPECIFICACIONES (UE)

E27 Max. 60W (no incluida)
220-240 V, 50/60 Hz, IP20, Clase II

ETIQUETA ENERGÉTICA

A ++

TECHNICAL

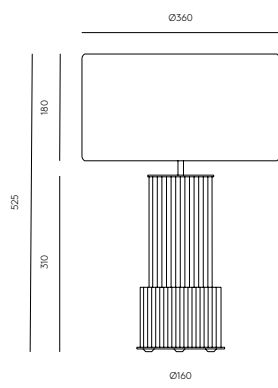

TARO 539€ (+IVA)

Table lamp

NAC113

Designed by AC Studio, 2019

DESCRIPTION

MATERIALS

Steel / Ceramic

FINISHES

Metal: Matt black / Matt white
Matt Brass / Shiny Gold / Chrome

Ceramics (Hand Painted):

See colour palette.

Image color: Green Leaf

IMAGE SHADE (Not Included)

801021/41

SPECIFICATIONS (UE)

E27 Max. 60W LED (not included)
220-240 V, 50/60 Hz, IP20, Class II

ENERGY LABEL

A ++



MATERIALES

Acero / Cerámica

ACABADOS

Metal: Negro mate/ Blanco mate/
Oro mate o brillo/ Cromo

Cerámica (Pintada a mano):

Consultar paleta de colores

Color de la imagen: Verde hoja

PANTALLA IMAGEN (No incluida)

801011/41

ESPECIFICACIONES (UE)

E27 Max. 60W LED (no incluida)
220-240 V, 50/60 Hz, IP20, Clase II

ETIQUETA ENERGÉTICA

A ++

TECHNICAL

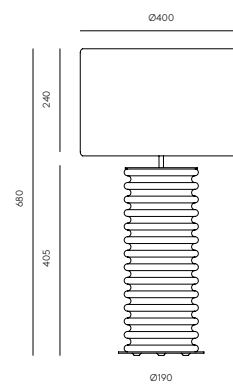

SHADOW 435€ (+IVA)

Table lamp

NAC112

Designed by AC Studio, 2019

DESCRIPTION

MATERIALS

Steel / Glass

FINISHES

Metal: Matt black / Matt white
Matt Brass / Shiny Gold /Chrome

Glass:
Clear

IMAGE SHADE 801011/36

Not included

SPECIFICATIONS (UE)

E27 Max. 60W (Not included)
220-240 V, 50/60 Hz,
IP20, Class II

ENERGY LABEL

A ++

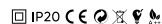

MATERIALES

Acero / Vidrio

ACABADOS

Metal: Negro mate/ Blanco mate / Oro mate o brillo/ Cromo

Vidrio:
Transparente

PANTALLA IMAGEN 801011/36

No incluida

ESPECIFICACIONES (UE)

E27 Max. 60W (no incluida)
220-240 V, 50/60 Hz,
IP20, Clase II

ETIQUETA ENERGÉTICA

A ++

TECHNICAL

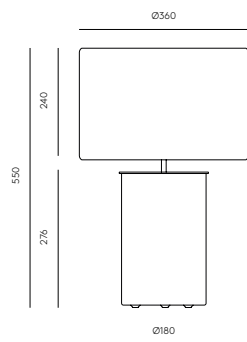

NOA 638€ (+IVA)

Table lamp

NAC110

Designed by AC Studio, 2016

DESCRIPTION

MATERIALS

Steel / Ceramic

FINISHES

Metal: Matt black / Matt white
Matt Brass / Shiny Gold /Chrome

Ceramics (Hand Painted):
See colour palette.

Image color: Make up

IMAGE SHADE 801011/41

Not included

SPECIFICATIONS (UE)

E27 Max. 60W LED (not included)
220-240 V, 50/60 Hz,
IP20, Class II

DIMMABLE OPTION

B211 11W (Dimmable) + Dimmer
(ask for extra cost)

ENERGY LABEL

A ++

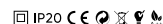

MATERIALES

Acero / Cerámica

ACABADOS

Metal: Negro mate/ Blanco mate
Oro mate o brillo/ Cromo

Cerámica (Pintada a mano):
Consultar paleta de colores

Color de la imagen: Maquillaje

PANTALLA IMAGEN 801011/41

No incluida

ESPECIFICACIONES (UE)

E27 Max. 60W LED (no incluida)
220-240 V, 50/60 Hz,
IP20, Clase II

POSIBILIDAD REGULACIÓN

B211 11W (Regulable) + Regulador
(sobrecoste a consultar)

ETIQUETA ENERGÉTICA

A ++

TECHNICAL

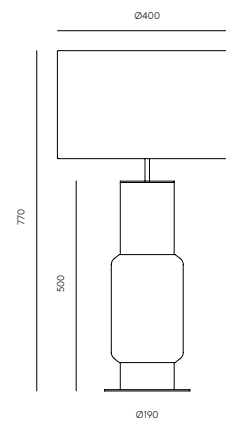



PONN PONN 651€ (+IVA)

Table lamp

NAC109
Designed by AC Studio, 2016

DESCRIPTION

MATERIALS

Steel / Glass / Leather

FINISHES

Metal: Matt black / Matt white
Matt Brass / Shiny Gold / Chrome

Glass (Hand Painted):
See colour palette.

Image color:

Left: Ash grey / Nude
Right: Light violet / Mineral red

IMAGE SHADE 801011/41
Not included

SPECIFICATIONS (UE)

E27 Max. 60W (Not included)
220-240 V, 50/60 Hz,
IP20, Class II

DIMMABLE OPTION

B211 11W (Dimmable) + Dimmer
(ask for extra cost)

ENERGY LABEL

A ++

IP20 CE ENEC

MATERIALES

Acero / Vidrio / Piel

ACABADOS

Metal: Negro mate/ Blanco mate
Oro mate o brillo/ Cromo

Vidrio (Pintado a mano):
Consultar paleta de colores

Color de la imagen:

Izda. Gris ceniza / Nude
Dcha. Violeta claro/Rojo mineral

PANTALLA IMAGEN 801011/41
No incluida

ESPECIFICACIONES (UE)

E27 Max. 60W (no incluida)
220-240 V, 50/60 Hz,
IP20, Clase II

POSIBILIDAD REGULACIÓN

B211 11W (Regulable) + Regulador
(sobrecoste a consultar)

ETIQUETA ENERGÉTICA

A ++

TECHNICAL

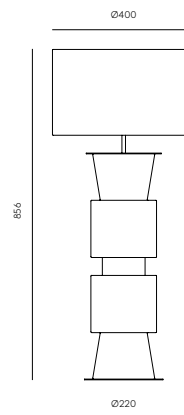

KITTA KITTA 628€ (+IVA)

Table lamp

NAC108

Designed by AC Studio, 2016

DESCRIPTION

MATERIALS

Steel / Glass / Leather

FINISHES

Metal: Matt black / Matt white
Matt Brass / Shiny Gold / Chrome

Glass (Hand Painted):
See colour palette.

Image color:

Up Sand Brown,
Down Green Leaf

IMAGE SHADE 801011/41

Not included

SPECIFICATIONS (UE)

E27 Max. 60W (Not included)
220-240 V, 50/60 Hz,
IP20, Class II

DIMMABLE OPTION

B211 11W (Dimmable) + Dimmer
(ask for extra cost)

ENERGY LABEL

A ++

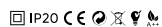

MATERIALES

Acero / Vidrio / Piel

ACABADOS

Metal: Negro mate/ Blanco
mate / Oro mate o brillo/ Cromo

Vidrio (Pintado a mano):
Consultar paleta de colores

Color de la imagen:

Arriba Arena Marrón /
Abajo Verde hoja

PANTALLA IMAGEN 801011/41

No incluida

ESPECIFICACIONES (UE)

E27 Max. 60W (no incluida)
220-240 V, 50/60 Hz,
IP20, Clase II

POSIBILIDAD REGULACIÓN

B211 11W (Regulable) + Regulador
(sobrecoste a consultar)

ETIQUETA ENERGÉTICA

A ++

TECHNICAL

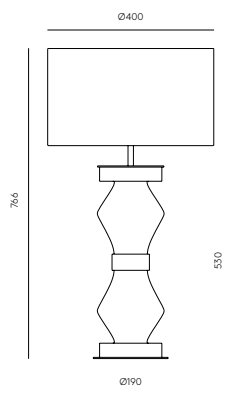

100



KITTA PONN 614€ (+IVA)

Table lamp

NAC107

Designed by AC Studio, 2016

DESCRIPTION

MATERIALS

Steel / Glass / Leather

FINISHES

Metal: Matt black / Matt white
Matt Brass / Shiny Gold / Chrome

Glass (Hand Painted):
See colour palette.

Image color:

Up Ash grey /
Down brown vintage

IMAGE SHADE 801011/40

Not included

SPECIFICATIONS (UE)

E27 Max. 60W (Not included)
220-240 V, 50/60 Hz,
IP20, Class II

DIMMABLE OPTION

B211 11W (Dimmable) + Dimmer
(ask for extra cost)

ENERGY LABEL

A ++

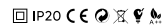

MATERIALES

Acero / Vidrio / Piel

ACABADOS

Metal: Negro mate/ Blanco
mate / Oro mate o brillo/ Cromo

Vidrio (Pintado a mano):
Consultar paleta de colores

Color de la imagen:

Arriba gris ceniza / Abajo marron
vintage

PANTALLA IMAGEN 801011/40

No incluida

ESPECIFICACIONES (UE)

E27 Max. 60W (no incluida)
220-240 V, 50/60 Hz,
IP20, Clase II

POSIBILIDAD REGULACIÓN

B211 11W (Regulable) + Regulador
(sobrecoste a consultar)

ETIQUETA ENERGÉTICA

A ++

TECHNICAL

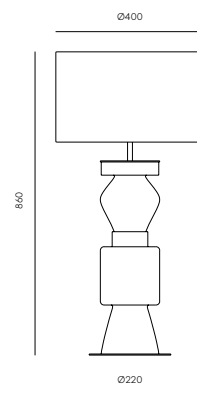

101



PONN 470€ (+IVA)

Table lamp

NAC106

Designed by AC Studio, 2016

DESCRIPTION

MATERIALS

Steel / Ceramic

FINISHES

Metal: Matt black / Matt white
Matt Brass / Shiny Gold / Chrome

Ceramics (Hand Painted):
See colour palette.

Image color: Mineral red

IMAGE SHADE 801011/36

Not included

SPECIFICATIONS (UE)

E27 Max. 60W LED (not included)
220-240 V, 50/60 Hz,
IP20, Class II

DIMMABLE OPTION

B211 11W (Dimmable) + Dimmer
(ask for extra cost)

ENERGY LABEL

A ++

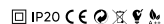

MATERIALES

Acero / Cerámica

ACABADOS

Metal: Negro mate/ Blanco mate
/ Oro mate o brillo/ Cromo

Cerámica (Pintada a mano):
Consultar paleta de colores

Color de la imagen: Mineral rojo

PANTALLA IMAGEN 801011/36

No incluida

ESPECIFICACIONES (UE)

E27 Max. 60W LED (no incluida)
220-240 V, 50/60 Hz,
IP20, Clase II

POSIBILIDAD REGULACIÓN

B211 11W (Regulable) + Regulador
(sobrecoste a consultar)

ETIQUETA ENERGÉTICA

A ++

TECHNICAL

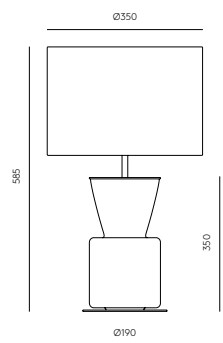

102

LUSA 544€ (+IVA)

Table lamp

NAC104

Designed by AC Studio, 2016

DESCRIPTION

MATERIALS

Steel / Ceramic

FINISHES

Metal: Matt black / Matt white
Matt Brass / Shiny Gold / Chrome

Ceramics (Hand Painted):
See colour palette.

Image color: Opal Violet

IMAGE SHADE 801011/41

Not included

SPECIFICATIONS (UE)

E27 Max. 60W LED (not included)
220-240 V, 50/60 Hz,
IP20, Class II

DIMMABLE OPTION

B211 11W (Dimmable) + Dimmer
(ask for extra cost)

ENERGY LABEL

A ++

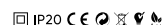

MATERIALES

Acero / Cerámica

ACABADOS

Metal: Negro mate/ Blanco
mate / Oro mate o brillo/ Cromo

Cerámica (Pintada a mano):
Consultar paleta de colores

Color de la imagen: Violeta Opal

PANTALLA IMAGEN 801011/41

No incluida

ESPECIFICACIONES (UE)

E27 Max. 60W LED (no incluida)
220-240 V, 50/60 Hz,
IP20, Clase II

POSIBILIDAD REGULACIÓN

B211 11W (Regulable) + Regulador
(sobrecoste a consultar)

ETIQUETA ENERGÉTICA

A ++

TECHNICAL

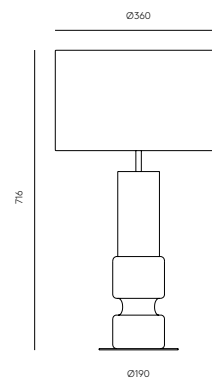

103

MELLY 497€ (+IVA)

Table lamp

NAC103

Designed by AC Studio, 2015

DESCRIPTION

MATERIALS

Steel / Glass

FINISHES

Metal: Matt black / Matt white
Matt Brass / Shiny Gold / Chrome

Glass (Hand Painted):
See colour palette.

Image color: Green leaf

IMAGE SHADE 151011/45

Not included

SPECIFICATIONS (UE)

E27 Max. 60W (Not included)
220-240 V, 50/60 Hz,
IP20, Class II

DIMMABLE OPTION

B211 11W (Dimmable) + Dimmer
(ask for extra cost)

ENERGY LABEL

A ++

IP20 CE E

MATERIALES

Acero / Vidrio

ACABADOS

Metal: Negro mate / Blanco
mate / Oro mate o brillo / Cromo

Vidrio (Pintado a mano):
Consultar paleta de colores

Color de la imagen: Verde hoja

PANTALLA IMAGEN 151011/45

No incluida

ESPECIFICACIONES (UE)

E27 Max. 60W (no incluida)
220-240 V, 50/60 Hz,
IP20, Clase II

POSIBILIDAD REGULACIÓN

B211 11W (Regulable) + Regulador
(sobrecoste a consultar)

ETIQUETA ENERGÉTICA

A ++

TECHNICAL

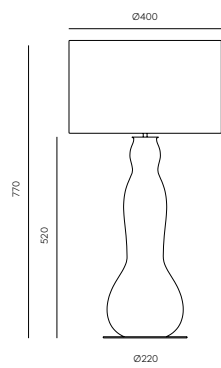

104



SAM 525€ (+IVA)

Table lamp

NAC093

Designed by AC Studio, 2013

DESCRIPTION

MATERIALS

Steel / Glass / Wood

FINISHES

Wood: Walnut

Glass: See colour palette.

Image color: Brown / Blue

IMAGE SHADE 801011/46

Not included

SPECIFICATIONS (UE)

E27 Max. 60W (Not included)
220-240 V, 50/60 Hz,
IP20, Class II

DIMMABLE OPTION

B211 11W (Dimmable) + Dimmer
(ask for extra cost)

ENERGY LABEL

A ++

IP20 CE E

MATERIALES

Acero / Vidrio / Madera

ACABADOS

Madera: Nogal

Vidrio: Ver paleta de colores

Color de la imagen: Marrón/Azul

PANTALLA IMAGEN 801011/46

No incluida

ESPECIFICACIONES (UE)

E27 Max. 60W (no incluida)
220-240 V, 50/60 Hz,
IP20, Clase II

POSIBILIDAD REGULACIÓN

B211 11W (Regulable) + Regulador
(sobrecoste a consultar)

ETIQUETA ENERGÉTICA

A ++

TECHNICAL

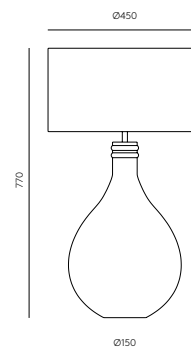

105





Pendant

Lamps

- 108 **TURA** · C1313
- 110 **ELMA** · C1312/S
- 113 **ELMA** · C1312/L
- 114 **ELLI** · C1311
- 116 **ELLI** · C1311/L
- 118 **DOUL** · C1310
- 120 **DOUL** · C1310/5
- 121 **TANA** · C1309/4
- 124 **TUYA** · C1308
- 126 **DUSSA** · C1307
- 127 **DUSSA** · C1307/6
- 130 **BION** · C1306/6
- 132 **STRIP** · C1303
- 133 **LEVEL** · C1302
- 134 **GRUYE** · C1301
- 137 **ICONIC** · C1300
- 138 **ONETA** · C1299
- 139 **ONETA-L** · C1299/L
- 140 **ISON** · C1298
- 141 **ISON** · C1298/5
- 144 **YCRO** · C1297
- 146 **TUBE** · C1296
- 147 **PIPE** · C1293
- 148 **ARC** · C1292
- 149 **PORTA-L** · C1290/L
- 150 **HAT** · C1291
- 152 **HAT** · C1291/S
- 154 **MIRO** · C1289
- 155 **MIRO** · C1289/6
- 156 **FITO** · C1286
- 157 **FITO-L** · C1286/L
- 158 **AMBOR** · C1283
- 159 **HUP** · C1282
- 160 **ATIL** · C1281
- 161 **ATIL** · C1281/6
- 164 **DALT** · C1280/6
- 165 **DALT** · C1280
- 166 **FOCUS** · C1279
- 168 **FOCUS** · C1279/4
- 169 **FOCUS** · C1279/1
- 170 **NOOI** · C1276
- 173 **NINO** · C1275
- 174 **LYB** · C1274
- 175 **COLN** · C1267
- 176 **GAND** · C1271
- 178 **CLIP** · C1265
- 180 **TERA** · C1260
- 182 **ABBACUS** · C1258
- 183 **ABBACUS** · C1258/1
- 184 **ERTO** · C1257/5
- 186 **FRAME** · C1246
- 188 **MAHO** · C1254/6
- 189 **OHLALA** · C1242
- 190 **CRANE** · C1241
- 191 **LUCA** · C1238
- 192 **LUCA+** · C1239/3
- 194 **LOTA** · C1235
- 196 **LITA** · C1230
- 197 **LITA** · C1230/4
- 198 **NERA SIX** · C1229/6
- 199 **NERA** · C1229
- 200 **DORA** · C1228
- 202 **ALOA** · C1227
- 203 **ALOA** · C1227/4
- 204 **DELIE** · C1224
- 205 **DELIE** · C1224/8
- 206 **FEST** · C1223
- 207 **HELMET** · C1221
- 208 **YOYO** · C1222
- 210 **LIND** · C1220
- 212 **BALL** · C1215
- 214 **ATOM** · C1214/8
- 215 **CUBE-X** · C1213
- 216 **MIKA** · C1204
- 217 **MIKA MULTI** · C1204/8
- 218 **BIGCOSS** · C1203/80
- 220 **ANET** · C1206
- 221 **MARU** · C1194
- 222 **DAMO** · C1191
- 223 **ELLA** · C1158
- 224 **ENDO** · C1156
- 227 **CHAPEAU** · C1157
- 228 **CORA** · C1129
- 230 **PTAN** · C1154
- 231 **COPO** · C1085
- 232 **BELL** · C1084
- 234 **ALPHA** · C1083
- 235 **BETA** · C1082
- 236 **GAMMA** · C1081
- 238 **ELLEN** · C1048
- 239 **CRAWFORD** · C1047
- 240 **DISC** · C1038
- 241 **OPEN** · C1034
- 242 **C1012** · C1012
- 243 **ANYA** · C1110 + 1143/1144
- 244 **DOUL** · T1310
- 245 **YCRO** · T1297
- 246 **YCRO** · T1297/4
- 248 **FOCUS** · T1279
- 249 **NOON** · T1278/1
- 250 **NOON** · T1278/3
- 251 **NOON** · T1278
- 254 **LATTO** · T1268
- 256 **TAMB 30-50** · T1019/30/50
- 257 **TAMB SQUARE** · T1016

TURA 293€ (+IVA)

C1313

Designed by JF Sevilla, 2023

DESCRIPTION

MATERIALS
Steel / Leather

MATERIALES
Metal / Cuero

FINISHES
Metal:
Matt black
Leather:
Black / Brown / Orange

ACABADOS
Metal:
Negro mate
Cuero:
Negro / Marrón / Naranja

SPECIFICATIONS
6 x LED chip 5W 2700K
dimmable
wired dimmer
24V, 50/60Hz
IP20, Class II

ESPECIFICACIONES
6 x Chip LED 5W 2700K
Regulable
Regulador en cable
24V, 50/60 Hz
IP20, Clase II

ENERGY LABEL
A ++

ETIQUETA ENERGÉTICA
A ++

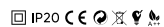

TECHNICAL

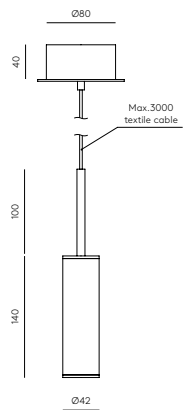

ELMA



Athens, Greece



ELMA 361€ (+IVA)

Pendant lamp

C1312/S

Designed by Jose Fornas, 2023

DESCRIPTION

MATERIALS

Metal / Glass / Acrylic

FINISHES

Metal: Matte Black / Matt Brass

Glass: Striped glass - Transparent

Acrylic - Opal

SPECIFICATIONS

LED strip 6W 2700K TRIAC dimmable

24V, 50/60Hz

IP20, Class I

ENERGY LABEL

A ++

⊕ IP20 CE E U 

MATERIALES

Metal / Vidrio / Acrílico

ACABADOS

Metal: Negro mate / Oro envejecido

Cristal:

Cristal estriado - Transparente

Acrílico - Opal

ESPECIFICACIONES

Tira LED 6W 2700K TRIAC

regulable

24V, 50/60 Hz

IP20, Clase I

ETIQUETA ENERGÉTICA

A ++



TECHNICAL

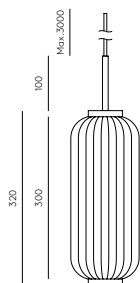

112

ELMA 994€ (+IVA)

Pendant lamp

C1312/L

Designed by Jose Fornas, 2023



DESCRIPTION

MATERIALS

Metal / Glass / Acrylic

FINISHES

Metal: Matte Black / Matt Brass

Glass: Striped glass - Transparent

Acrylic - Opal

SPECIFICATIONS

LED strip 20W 2700K TRIAC

dimmable

24V, 50/60Hz

IP20, Class I

ENERGY LABEL

A ++

⊕ IP20 CE E U 

MATERIALES

Metal / Vidrio / Acrílico

ACABADOS

Metal: Negro mate / Oro envejecido

Cristal:

Cristal estriado - Transparente

Acrílico - Opal

ESPECIFICACIONES

Tira LED 20W 2700K TRIAC

regulable

24V, 50/60 Hz

IP20, Clase I

ETIQUETA ENERGÉTICA

A ++

TECHNICAL

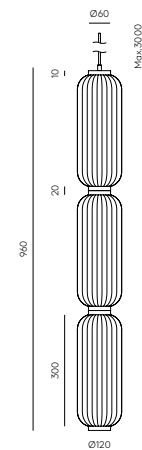

113

ELLI 620€ (+IVA)

Pendant lamp

C1311/S

Designed by JF Sevilla, 2023

DESCRIPTION

MATERIALS

Metal / Acrylic

FINISHES

Metal: Matte Black / Antique Gold
Acrylic: - Opal

SPECIFICATIONS

LED chip 5W 2700K TRIAC dimmable
24V, 50/60Hz
IP20, Class I

ENERGY LABEL

A ++

MATERIALES

Metal / Acrílico

ACABADOS

Metal: Negro mate / Oro envejecido
Acrílico: - Opal

ESPECIFICACIONES

Chip LED 5W 2700K TRIAC regulable
24V, 50/60 Hz
IP20, Clase I

ETIQUETA ENERGÉTICA

A ++

IP20 CE RoHS WEEE

TECHNICAL

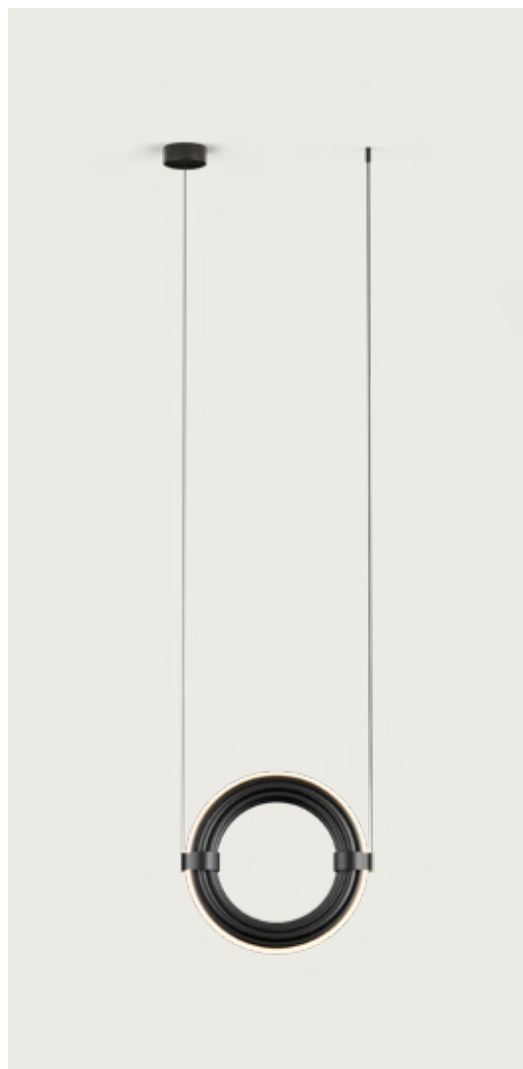
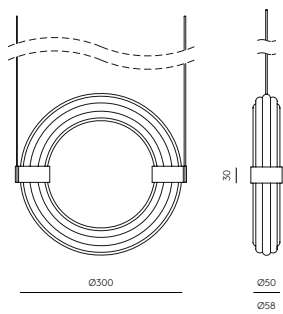

Oslo, Norway

Aarhus, Denmark

ELLI 1,278€ (+IVA)

Pendant lamp

C1311/L
Designed by JF Sevilla, 2023

DESCRIPTION

MATERIALS
Metal / Acrylic

MATERIALES
Metal / Acrílico

FINISHES
Metal: Matte Black / Antique Gold
Acrylic - Opal

ACABADOS
Metal: Negro mate / Oro
envejecido
Acrílico - Opal

SPECIFICATIONS
LED strip 30W DALI/PUSH CCT
dimmmable (adjust power and
temperature)
24V, 50/60Hz
IP20, Class I

ESPECIFICACIONES
Tira LED 30W DALI/PUSH CCT
regulable (ajusta potencia y
temperatura)
24V, 50/60 Hz
IP20, Clase I

ENERGY LABEL
A ++

ETIQUETA ENERGÉTICA
A ++

Ⓜ IP20 CE RoHS REACH

TECHNICAL

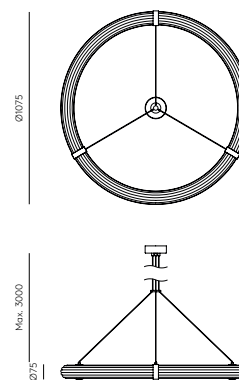

DOUL 261€ (+IVA)

Pendant lamp

C1310

Designed by Agus Gascón, 2023

DESCRIPTION

MATERIALS

Steel / Glass

FINISHES

Body: Matt black / Matt Brass

Glass: Striped glass - Transparent

SPECIFICATIONS (UE)

G4 LEDs 3W 2700K

Adjustable (Included)

Regulation on cable

220-240V, 50/60Hz

IP20, Class I

ENERGY LABEL

A ++

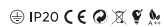

MATERIALES

Metal / Vidrio

ACABADOS

Cuerpo: Negro mate / Oro envejecido

Cristal: Cristal rayado - Transparente

ESPECIFICACIONES (UE)

G4 LED 3W 2700K

Regulable (Incluida)

Regulación en cable

220-240 V, 50/60 Hz

IP20, Clase I

ETIQUETA ENERGÉTICA

A ++

TECHNICAL

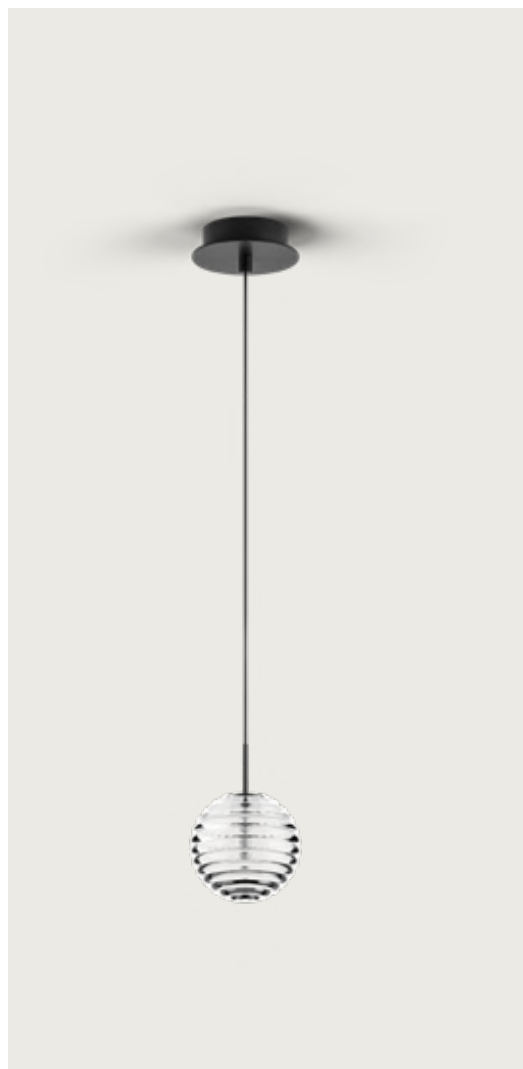
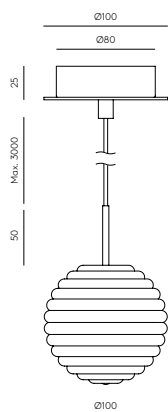

Paris, France

DOUL 1,315€ (+IVA)

C1310/5

Designed by Agus Gascón, 2023

DESCRIPTION

MATERIALS

Steel / Glass

FINISHES

Body:
Matt black / Matt Brass



Glass:
Striped glass - Transparent

SPECIFICATIONS (UE)

5 x G4 LEDs 3W 2700K
Dimmer (Included)
220-240V, 50/60Hz
IP20, Class I

ENERGY LABEL

A ++

⊕ IP20 CE   

MATERIALES

Metal / Vidrio

ACABADOS

Cuerpo:
Negro mate / Oro envejecido

Cristal:
Cristal rayado - Transparente

ESPECIFICACIONES (UE)

5 x G4 LED 3W 2700K
Regulable (Incluida)
220-240 V, 50/60 Hz
IP20, Clase I

ETIQUETA ENERGÉTICA

A ++

TECHNICAL

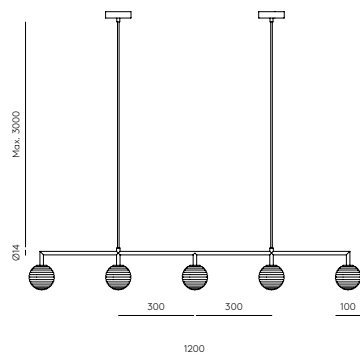

120

Marseille, France



Berlin, Germany



TANA 609€ (+IVA)

Pendant lamp

C1309/4

Designed by JF Sevilla, 2022

DESCRIPTION

MATERIALS

Steel

FINISHES

Steel:
Matt black

SPECIFICATIONS

4x Chip LED 4W - 2700K
(Incluida)
Dimmer: Dali/Push - TRIAC
220-240V - 24V - 50/60 Hz
IP20 - Class I

ENERGY LABEL

A ++

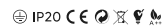

MATERIALES

Metal

ACABADOS

Metal:
Negro mate

ESPECIFICACIONES

4x Chip LED 4W - 2700K
(Incluida)
Regulación: Dali/Push - TRIAC
220-240V - 24V - 50/60 Hz
IP20 - Clase I

ETIQUETA ENERGÉTICA

A ++

TECHNICAL

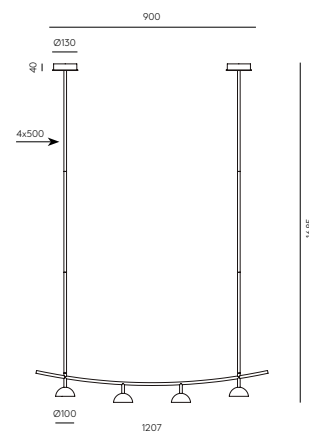

TUYA 1,148€ (+IVA)

C1308

Designed by JF Sevilla, 2022

DESCRIPTION

MATERIALS

Rattan / Steel / Acrylic

FINISHES

Rattan: Black
Metal: Antique Gold
Acrylic: Opal

SPECIFICATIONS

LED strip 20W - 2700K
TRIAC Dimmable
24V, 50/60Hz
IP20, Class I

ENERGY LABEL

A++

IP20 CE RoHS RECYCLED

MATERIALES

Rattan / Acero / Acrílico

ACABADOS

Rattan: Negro
Metal: Oro envejecido
Acrílico: Opal

ESPECIFICACIONES

Tira LED 20W - 2700K
TRIAC Regulable
24V, 50/60 Hz
IP20, Clase I

ETIQUETA ENERGÉTICA

A++

TECHNICAL

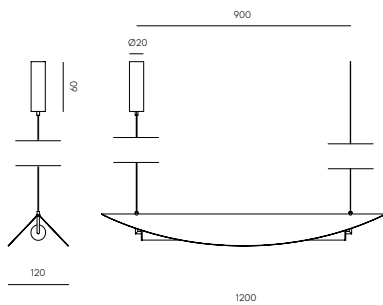

DUSSA 308€ (+IVA)

Pendant lamp

C1307

Designed by Pepe Fornas, 2022

DESCRIPTION

MATERIALS
Steel/Marble

MATERIALES
Metal / Mármol

FINISHES

Steel:
Matt black
Matt Brass

ACABADOS

Metal:
Negro mate
Oro envejecido

Marble:
Black
White
Travertine

Mármol:
Negro
Blanco
Travertino

SPECIFICATIONS
Led Plate 9W 2700K
Dimmer Dali-Push driver
24 V, 50/60 Hz
IP20 - Class II

ESPECIFICACIONES
Placa LED 9W - 2700K
Regulador por Dali-Push
24 V, 50/60 Hz
IP20, Clase II

ENERGY LABEL
A ++

ETIQUETA ENERGÉTICA
A ++

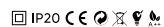

TECHNICAL

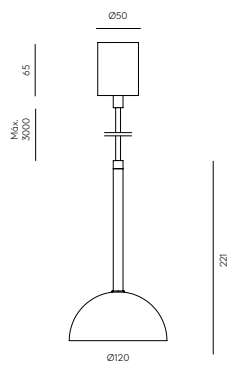

DUSSA 1,568€ (+IVA)

Pendant lamp

C1307/6

Designed by Pepe Fornas, 2022

DESCRIPTION

MATERIALS
Steel/Marble

MATERIALES
Metal / Mármol

FINISHES

Steel:
Matt black
Matt Brass

ACABADOS

Metal:
Negro mate
Oro envejecido

Marble:
Black
White
Travertine

Mármol:
Negro
Blanco
Travertino

SPECIFICATIONS
6 Led Plate 9W 2700K
Dimmer Dali-Push driver
24 V, 50/60 Hz
IP20 - Class II

ESPECIFICACIONES
6 Placa LED 9W - 2700K
Regulador por Dali-Push
24 V, 50/60 Hz
IP20, Clase II

ENERGY LABEL
A ++

ETIQUETA ENERGÉTICA
A ++

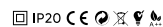

TECHNICAL

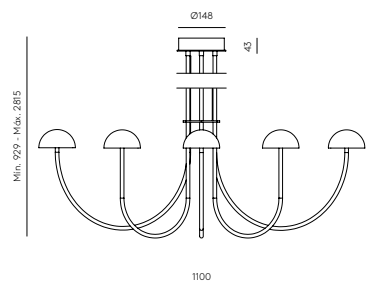

DUSSA



Vienna, Austria



Rotterdam, Netherlands

BION 1,715€ (+IVA)

Pendant lamp

C1306/6

Designed by Pepe Fornas, 2022



DESCRIPTION

MATERIALS

Steel

FINISHES

Body:
Matt black
Aged gold

Shade:
Matt black
Matt white

SPECIFICATIONS

6xG9 LED 5W 2700K
Dimmable (Included)
Possibility to dimmer
with Dali/ Push driver
Interface (DALI/230V)
220-240 V, 50/60 Hz
IP20, Class II

ENERGY LABEL

A ++

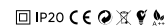

MATERIALES

Metal

ACABADOS

Cuerpo:
Negro mate
Oro envejecido

Tulipa:
Negro mate
Blanco mate

ESPECIFICACIONES

6xG9 LED 5W 2700K
Regulable (Incluida)
Posibilidad de regulación
por Dali/ Push
Interfaz (DALI/230V)
220-240 V, 50/60 Hz
IP20, Clase II

ETIQUETA ENERGÉTICA

A ++

TECHNICAL

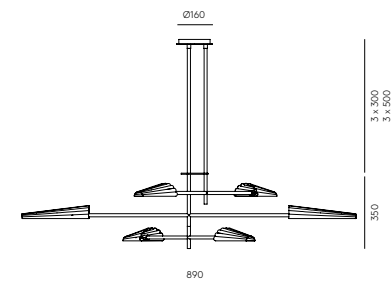

STRIP 347€ (+IVA)

Pendant lamp

C1303

Designed by AC Studio, 2022

DESCRIPTION

MATERIALS

Steel

FINISHES

Matt Black
Aged Gold
Anthracite
Rose Copper

SPECIFICATIONS

GU10 LED 5W - 2700K (incl.)
220-240V - 50/60 Hz
Class I - IP20

ENERGY LABEL

A ++

DIMMABLE OPTION

B161 (Dimmable) + Dimmer
Interface Dali/Push (Dali/230V)
(Ask for extra cost)

IP20 CE E

MATERIALES

Metal

ACABADOS

Negro Mate
Oro envejecido
Antracita
Cobre Rosado

ESPECIFICACIONES

GU10 LED 5W - 2700K (incl.)
220-240V - 50/60 Hz
Clase I - IP20

ETIQUETA ENERGÉTICA

A ++

POSIBILIDAD REGULACIÓN

B161 (Regulable) + Regulador
Interfaz Dali/Push (Dali/230V)
(sobrecoste a consultar)

TECHNICAL

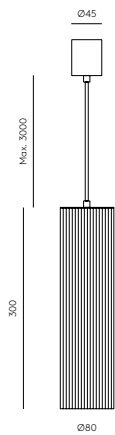

LEVEL 60cm: 803€ (+IVA) 80cm: 871€ (+IVA)

Pendant lamp

C1302

Designed by Pepe Fornas, 2022



DESCRIPTION

MATERIALS

Steel / Glass

FINISHES

Metal:
Matt black
Aged Gold
Glass:
Opal
Stripped glass clear
(consult us for other finishes)

SPECIFICATIONS

2xG9 LED 5W - 2700K (incl.)
220-240V - 50/60 Hz
Class I - IP20

ENERGY LABEL

A ++

DIMMABLE OPTION

2 x B005 (Dimmable) + Dimmer
Interface Dali/Push (Dali/230V)
(ask for extra cost)

IP20 CE E

MATERIALES

Acero / Vidrio

ACABADOS

Metal:
Oro envejecido
Antracita
Vidrio:
Opal
Transparente Estriado
(consulte para otros acabados)

ESPECIFICACIONES

2xG9 LED 5W - 2700K (incl.)
220-240V - 50/60 Hz
IP20 - Clase I

ETIQUETA ENERGÉTICA

A ++

POSIBILIDAD REGULACIÓN

2x B005 (Regulable) + Regulador
Interfaz Dali/Push (Dali/230V)
(sobrecoste a consultar)

TECHNICAL

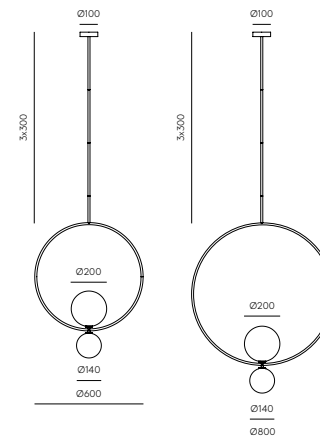

C1302/60

C1302/80



LEVEL



Málaga, Spain

GRUYE 1,118€ (+IVA)

Pendant lamp

C1301

Designed by Pepe Fornas, 2022



DESCRIPTION

MATERIALS
Steel / Glass

FINISHES

Metal:
Matt black
Aged Gold
Glass:
Opal

SPECIFICATIONS

4xG9 LED 5W - 2700K (incl.)
220-240V - 50/60 Hz
Class I - IP20

ENERGY LABEL
A ++

DIMMABLE OPTION

4 x B005 (Dimmable) + Dimmer
Interface Dali/Push (Dali/230V)
(ask for extra cost)

IP20 CE E U L

MATERIALES
Acero / Vidrio

ACABADOS

Metal:
Oro envejecido
Antracita
Vidrio:
Opal

ESPECIFICACIONES

4xG9 LED 5W - 2700K (incl.)
220-240V - 50/60 Hz
IP20 - Clase I

ETIQUETA ENERGÉTICA
A ++

POSIBILIDAD REGULACIÓN

4 x B005 (Regulable) + Regulador
Interfaz Dali/Push (Dali/230V)
(sobrecoste a consultar)

TECHNICAL

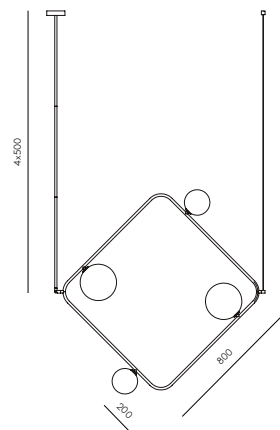

ICONIC 324€ (+IVA)

Pendant lamp

C1300

Designed by Agus Gascón, 2022

DESCRIPTION

MATERIALS
Steel / Marble

FINISHES

Metal:
Matt black
Aged Gold
Marble:
Finnish marble

SPECIFICATIONS

COB LED 7W 2700K
TRIAC Dimmable
220-240V - 24V - 50/60 Hz
Class I - IP20

ENERGY LABEL
A ++

IP20 CE E U L

MATERIALES
Acero / Mármol

ACABADOS

Metal:
Negro Mate
Oro envejecido
Mármol:
Finlandés

ESPECIFICACIONES

Placa LED 7W 2700K
TRIAC Regulable
220-240V - 24V - 50/60 Hz
Clase I - IP20

ETIQUETA ENERGÉTICA
A ++

TECHNICAL

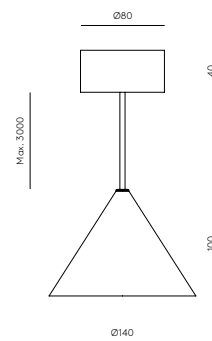

ONETA 284€ (+IVA)

Pendant lamp

C1299

Designed by Pepe Fornas, 2022

DESCRIPTION

MATERIALS

Steel / Marble / Glass

FINISHES

Metal:
Matt black
Aged Gold

Marble:
Matt White
Matt Black

Glass:
Opal

SPECIFICATIONS

G4 LED 3W - 2700K (incl.)
Dimmable
220-240V - 50/60 Hz
Class I - IP20

ENERGY LABEL

A ++

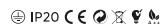

MATERIALES

Acero /Mármol /Vidrio

ACABADOS

Metal:
Oro envejecido
Antracita

Mármol:
Negro Mate
Blanco Mate

Vidrio:
Opal

ESPECIFICACIONES

G4 LED 3W - 2700K (incl.)
Regulable
220-240V - 50/60 Hz
Clase I - IP20

ETIQUETA ENERGÉTICA

A ++

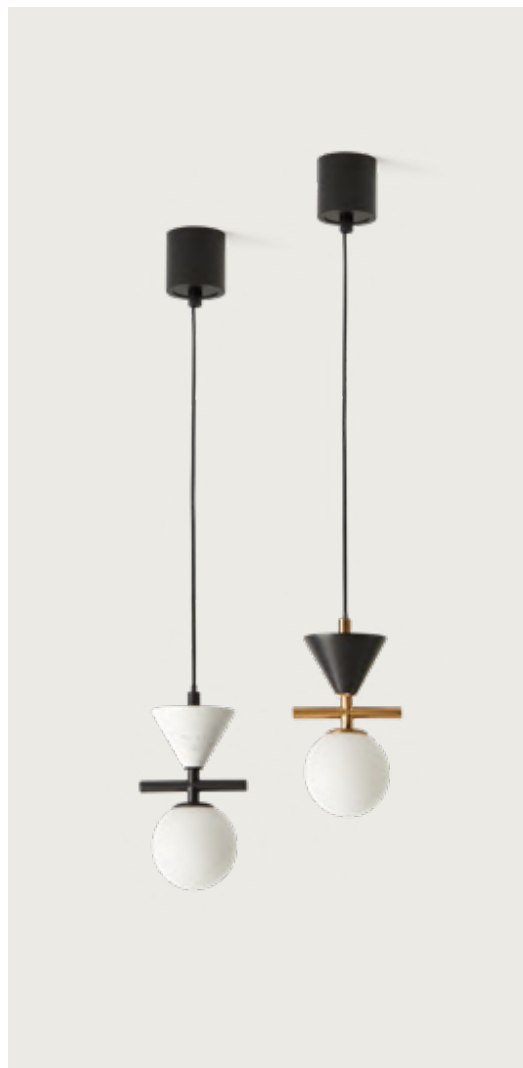

TECHNICAL

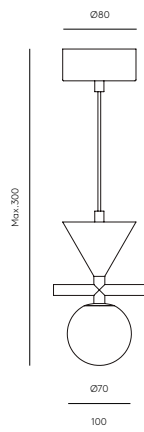

138

ONETA•L Negro Mate: 1,528€ (+IVA) Oro Envejecido: 1,598€ (+IVA)

Pendant lamp

C1299-L

Designed by Pepe Fornas, 2022



DESCRIPTION

MATERIALS

Steel / Marble / Glass

FINISHES

Metal:
Matt black
Aged Gold

Marble:
Matt White
Matt Black

Glass:
Opal

SPECIFICATIONS

6x G4 LED 3W - 2700K (incl.)
TRIAC Dimmable
220-240V - 50/60 Hz
Class I - IP20

ENERGY LABEL

A ++



MATERIALES

Acero /Mármol /Vidrio

ACABADOS

Metal:
Oro envejecido
Antracita

Mármol:
Negro Mate
Blanco Mate

Vidrio:
Opal

ESPECIFICACIONES

6x G4 LED 3W - 2700K (incl.)
TRIAC Regulable
220-240V - 50/60 Hz
Clase I - IP20

ETIQUETA ENERGÉTICA

A ++

TECHNICAL

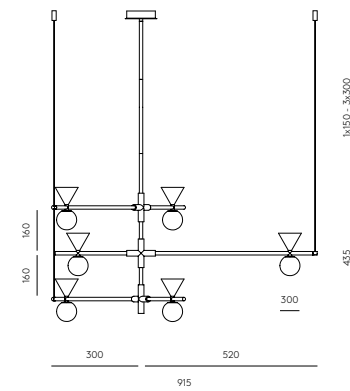

139

ISON 333€ (+IVA)

Pendant lamp

C1298

Designed by Pepe Fornas, 2022

DESCRIPTION

MATERIALS

Steel

FINISHES



Matt black
Matt gold

SPECIFICATIONS

Integrated LED stripe
8W - 2700K
Dimmable by TRIAC
220-240V - 24V - 50/60Hz
IP20 - Class I

ENERGY LABEL

A ++

⊕ IP20 CE E U  

MATERIALES

Acero

ACABADOS

Negro mate
Oro mate

ESPECIFICACIONES

Tira LED integrada
8W - 2700K
Regulable por TRIAC
220-240V - 24V - 50/60 Hz
IP20 - Clase I

ETIQUETA ENERGÉTICA

A ++

TECHNICAL

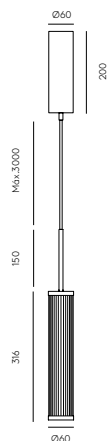

ISON 1,343€ (+IVA)

Pendant lamp

C1298/5

Designed by Pepe Fornas, 2021



DESCRIPTION

MATERIALS

Steel

FINISHES

Matt black
Matt gold

SPECIFICATIONS

5x Integrated LED stripe
8W - 2700K
Dimmable by TRIAC
220-240V - 24V - 50/60Hz
IP20 - Class I

ENERGY LABEL

A ++

⊕ IP20 CE E U  

MATERIALES

Acero

ACABADOS

Negro mate
Oro mate

ESPECIFICACIONES

5x Tira LED integrada
8W - 2700K
Regulable por TRIAC
220-240V - 24V - 50/60 Hz
IP20 - Clase I

ETIQUETA ENERGÉTICA

A ++

TECHNICAL

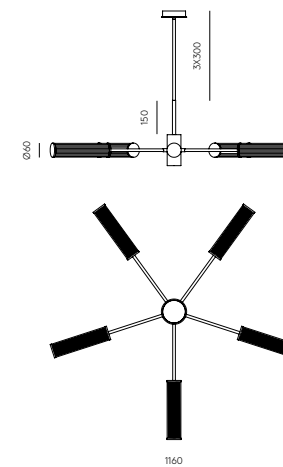

Goteborg, Sweden



ISON

TUBE 630€ (+IVA)

Pendant lamp

C1296

Designed by JF Sevilla, 2021



DESCRIPTION

MATERIALS

Steel / Acrylic

FINISHES

Metal:
Matt black
Matt gold

Acrylic:
Opal

SPECIFICATIONS

20W LED strip
2700K TRIAC Dimmable
24 V, 50/60 Hz
IP20, Class I

STEEL WIRE FOR HORIZONTAL
USE INCLUDED

ENERGY LABEL
A ++



MATERIALES

Acero / Acrílico

ACABADOS

Metal:
Negro mate
Oro mate

Acrílico:
Opal

ESPECIFICACIONES

Tira LED 20W
2700K TRIAC Regulable
24 V, 50/60 Hz
IP20, Clase I

STEEL WIRE FOR HORIZONTAL
USE INCLUDED

ETIQUETA ENERGÉTICA
A ++

TECHNICAL

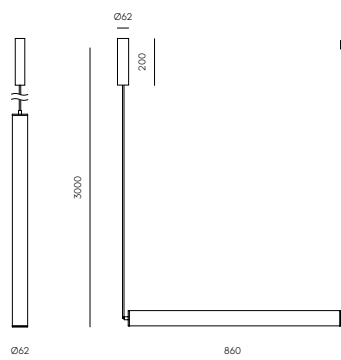

PIPE 938€ (+IVA)

Pendant lamp

C1293

Designed by AC Studio, 2021



DESCRIPTION

MATERIALS

Steel

FINISHES

Metal:
Matt black

SPECIFICATIONS

6 x GU10 3W, 3000K
TRIAC dimmable
(included) 230V, 50/60 Hz
IP20, Class I

ENERGY LABEL

A ++



MATERIALES

Acero

ACABADOS

Metal:
Negro mate

ESPECIFICACIONES

6 x GU10 3W, 3000K
TRIAC regulable
(incluida) 230V, 50/60 Hz
IP20, Clase I

ETIQUETA ENERGÉTICA

A ++

TECHNICAL

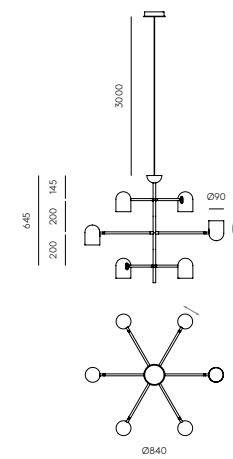

ARC 954€ (+IVA)

Pendant lamp

C1292

Designed by JF Sevilla, 2021



DESCRIPTION

MATERIALS
Steel / Acrylic

FINISHES

Metal:
Matt black
Matt gold

Acrylic:
Opal

SPECIFICATIONS

20W LED strip
2700K TRIAC Dimmable
24 V, 50/60 Hz
IP20, Class I

ENERGY LABEL
A ++



MATERIALES
Acero / Acrílico

ACABADOS
Metal:
Negro mate
Oro mate

Acrílico:
Opal

ESPECIFICACIONES

Tira LED 20W
2700K TRIAC Regulable
24 V, 50/60 Hz
IP20, Clase I

ETIQUETA ENERGÉTICA
A ++

TECHNICAL

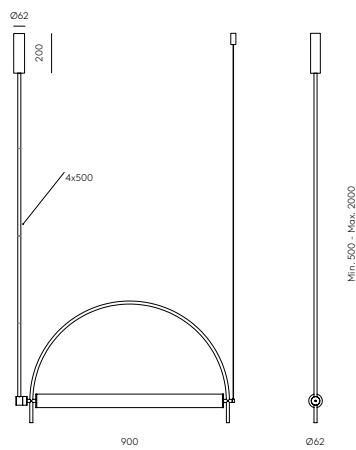

PORTA·L 419€ (+IVA)

Pendant lamp

C1290-L

Designed by Estudi Hac, 2021

DESCRIPTION

MATERIALS
Steel / Glass

FINISHES

Metal:
Matt black

Glass:
Smoked grey,

SPECIFICATIONS

9W LED plates
2700K TRIAC Dimmable
24 V, 50/60 Hz
IP20, Class I

ENERGY LABEL

A ++



MATERIALES
Acero / Vidrio

ACABADOS

Metal:
Negro mate

Vidrio:
Negro mate

ESPECIFICACIONES

Placas LED 9W
2700K TRIAC Regulable
24 V, 50/60 Hz
IP20, Clase I

ETIQUETA ENERGÉTICA

A ++

TECHNICAL

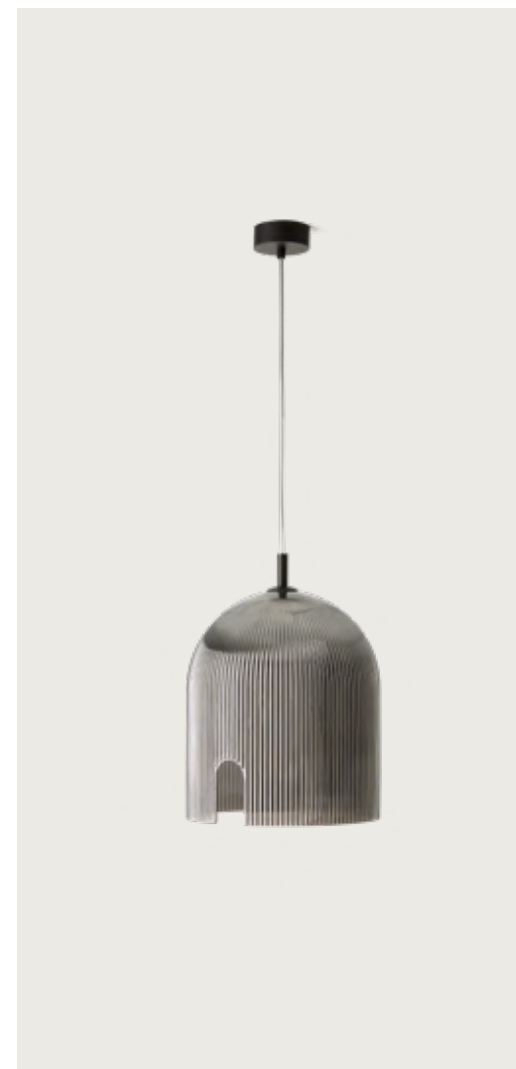
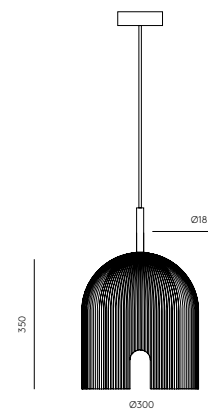



HAT 665€ (+IVA)

Pendant lamp

C1291
Designed by Pepe Fornas, 2021



DESCRIPTION

MATERIALS

Steel / Marble / Acrylic

FINISHES

Metal:
Matt White
Matt Gold

Marble:
Matt black
Matt white

SPECIFICATIONS

9W LED plate
2700K TRIAC Dimmable
24 V, 50/60 Hz
IP20, Class I

ENERGY LABEL
A ++



TECHNICAL

MATERIALES

Acero / Mármol / Acrílico

ACABADOS

Metal:
Blanco Mate
Oro Mate

Mármol:
Negro mate
Blanco Mate

ESPECIFICACIONES

Placa LED 9W
2700K TRIAC Regulable
24 V, 50/60 HZ
IP20, Clase I

ETIQUETA ENERGÉTICA
A ++

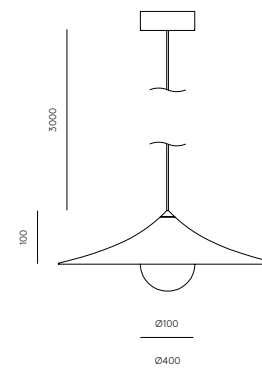

HAT 630€ (+IVA)

Pendant lamp

C1291/S

Designed by Pepe Fornas, 2022



DESCRIPTION

MATERIALS

Steel / Acrylic

FINISHES

Metal Shade:
Matt White
Matt Gold

SPECIFICATIONS

9W LED plate
2700K TRIAC Dimmable
24 V, 50/60 Hz
IP20, Class I

ENERGY LABEL

A ++



TECHNICAL

MATERIALES

Acero / Acrílico

ACABADOS

Tulipa Metal:
Blanco Mate
Oro Mate

ESPECIFICACIONES

Placa LED 9W
2700K TRIAC Regulable
24 V, 50/60 HZ
IP20, Clase I

ETIQUETA ENERGÉTICA

A ++

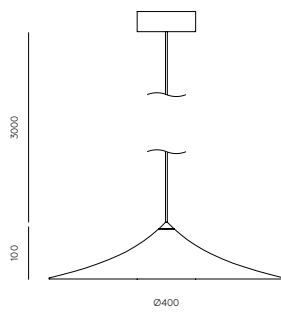

MIRO Alabastro: 363€ (+IVA)
 Cerámica: 307€ (+IVA)
 Vidrio: 338€ (+IVA)
 Acero: 300€ (+IVA)

Pendant lamp

C1289
 Designed by AC Studio, 2021

DESCRIPTION

MATERIALS

Steel / Blown Glass

FINISHES

Metal: Matt black
Shade (included): Opal
Recommended Bulb: B005/5W.

COMPATIBLE ACCESSORIES

(Not included in the price, choose one from list below)

Alabaster: 1096/35 - 1289/20/A
Ceramic: 1097/20 - 1097/30
Glass: 1223/25
Metalic disc: 1289/20

SPECIFICATIONS

G9 LED (included) 5W 2700K
 220-240V, 50/60 Hz,
 IP20, Clase I

ENERGY LABEL

A ++

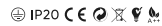

MATERIALES

Acero / Vidrio Soplado

ACABADOS

Metal: Negro mate
Tulipa (incluidas): Opal
Bombilla recomendada: B005/5W.

ACCESORIOS COMPATIBLES

(No incluido en el precio, elige uno de la siguiente lista)

Alabastro: 1096/35 - 1289/20/A
Cerámica: 1097/20 - 1097/30
Cristal: 1223/25
Disco Metal: 1289/20

ESPECIFICACIONES

G9 LED (incluido) 5W 2700K
 24 V, 50/60 Hz,
 IP20, Clase I

ETIQUETA ENERGÉTICA

A ++

TECHNICAL

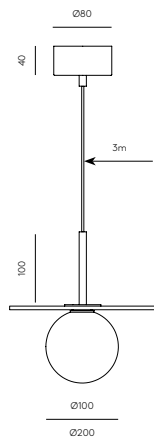

MIRO Alabastro: 2,807€ (+IVA)
 Cerámica: 2,471€ (+IVA)
 Vidrio: 2,660€ (+IVA)
 Acero: 2,429€ (+IVA)

Pendant lamp

C1289/6
 Designed by AC Studio, 2021



DESCRIPTION

MATERIALS

Steel / Blown Glass

FINISHES

Metal: Matt black
Shades (included): Opal
Recommended Bulbs: B005/5W

COMPATIBLE ACCESSORIES

(Not included in the price, choose one from list below)

Alabaster: 1096/35 - 1289/20/A
Ceramic: 1097/20 - 1097/30
Glass: 1223/25
Metalic disc: 1289/20

SPECIFICATIONS

6x G9 LED (included) 5W 2700K
 220-240V, 50/60 Hz,
 IP20, Clase I

ENERGY LABEL

A ++



MATERIALES

Acero / Vidrio Soplado

ACABADOS

Metal: Negro mate
Tulipas (incluidas): Opal
Bombillas recomendada: B005/5W

ACCESORIOS COMPATIBLES

(No incluido en el precio, elige uno de la siguiente lista)

Alabastro: 1096/35 - 1289/20/A
Cerámica: 1097/20 - 1097/30
Cristal: 1223/25
Disco Metal: 1289/20

ESPECIFICACIONES

6x G9 LED (incluido) 5W 2700K
 24 V, 50/60 Hz,
 IP20, Clase I

ETIQUETA ENERGÉTICA

A ++

TECHNICAL

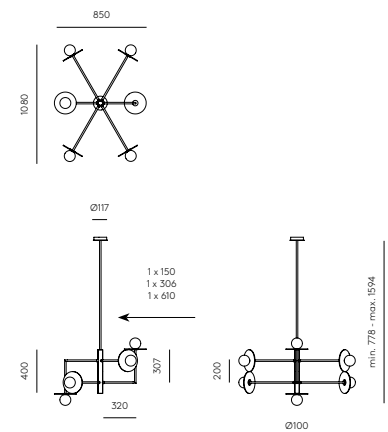

FITO 25 cm: 273€ (+IVA)
50 cm: 359€ (+IVA)

Pendant lamp

C1286

Designed by Pepe Fornas, 2020

DESCRIPTION

MATERIALS

Steel

FINISHES

Base:
Matt Brass

Rack:
Matt Black / Matt White

Rack tube sizes:

C1285/50 - 50 cm
C1285/25 - 25 cm

Recommended Bulb:
B050

SPECIFICATIONS

E27 (Bulb not included)
220-240 V, 50/60 Hz
IP20, Class II

ENERGY LABEL

A ++

MATERIALES

Acero

ACABADOS

Base:
Oro mate

Rejilla:
Negro mate / Blanco mate

Medidas tubo rejilla:

C1285/50 - 50 cm
C1285/25 - 25 cm

Bombilla recomendada:
B050

ESPECIFICACIONES

E27 (Bombilla no incluida)
220-240 V, 50/60 Hz
IP20, Clase II

ETIQUETA ENERGÉTICA

A ++

TECHNICAL

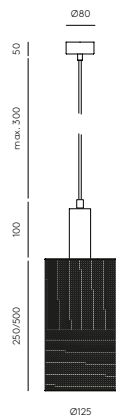

156

FITO-L 636€ (+IVA)

Pendant lamp

C1286/L

Designed by Pepe Fornas, 2022



DESCRIPTION

MATERIALS

Steel

FINISHES

Body:
Matt Black

Rack:
Matt Gold

SPECIFICATIONS

T8 LED 14W- 3000K, (incl.)
220-240V, 50/60 Hz
IP20, Class I

NOT DIMMABLE

ENERGY LABEL

A ++

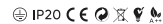

MATERIALES

Acero

ACABADOS

Cuerpo:
Negro mate

Rejilla:
Oro mate

ESPECIFICACIONES

T8 LED 14W- 3000K, (incl.)
220-240V, 50/60 Hz
IP20, Clase I

NO REGULABLE

ETIQUETA ENERGÉTICA

A ++

TECHNICAL

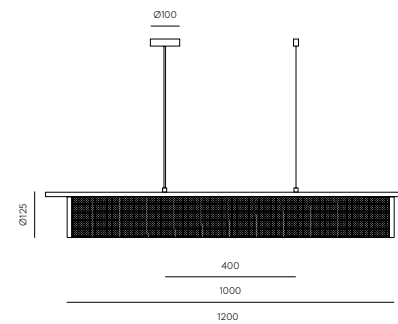

157

AMBOR 284€ (+IVA)

Pendant lamp

C1283

Designed by Pepe Fornas, 2019

DESCRIPTION

MATERIALS
Steel / Acrylic

MATERIALES
Acero / Acrílico

FINISHES

Cable:
Matt Black

ACABADOS
Negro mate

Shade:
Matt Brass
Matt Black

Pantalla:
Oro mate
Negro mate

Diffuser:
Opal

Diffuser:
Opal

SPECIFICATIONS

G9 Led Dimmable Bulbs
(Incl.) 3 x 3W - 3000K
220-240 V, 50/60 Hz
IP20, Class II

ESPECIFICACIONES

Bombillas G9 Led Regulables
(Incl.) 3 x 3W - 3000K
220-240 V, 50/60 Hz
IP20, Clase II

ENERGY LABEL

A ++

ETIQUETA ENERGÉTICA

A ++

TECHNICAL

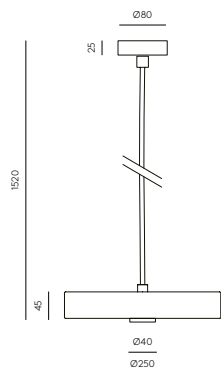

158



HUP 476€ (+IVA)

Pendant lamp

C1282

Designed by Pepe Fornas, 2019

DESCRIPTION

MATERIALS
Steel / Glass

MATERIALES
Acero / Vidrio

FINISHES

Metal:
Matt Brass

ACABADOS
Oro mate

Shade:
Opal

Pantalla:
Opal

SPECIFICATIONS

E27 (Not included) Max. 60W
220-240 V, 50/60 Hz
IP20, Class I

ESPECIFICACIONES

E27 (No incluida) Max. 60W
220-240 V, 50/60 Hz
IP20, Clase I

RECOMMENDED BULB

B211 (7, 9, 11W)

BOMBILLA RECOMENDADA

B211 (7, 9, 11W)

ENERGY LABEL

A ++

ETIQUETA ENERGÉTICA

A ++

IP20 CE ENEC

TECHNICAL

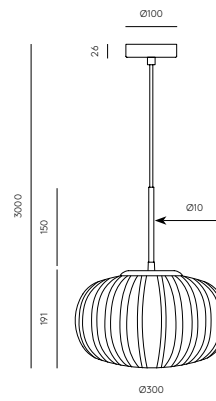

159

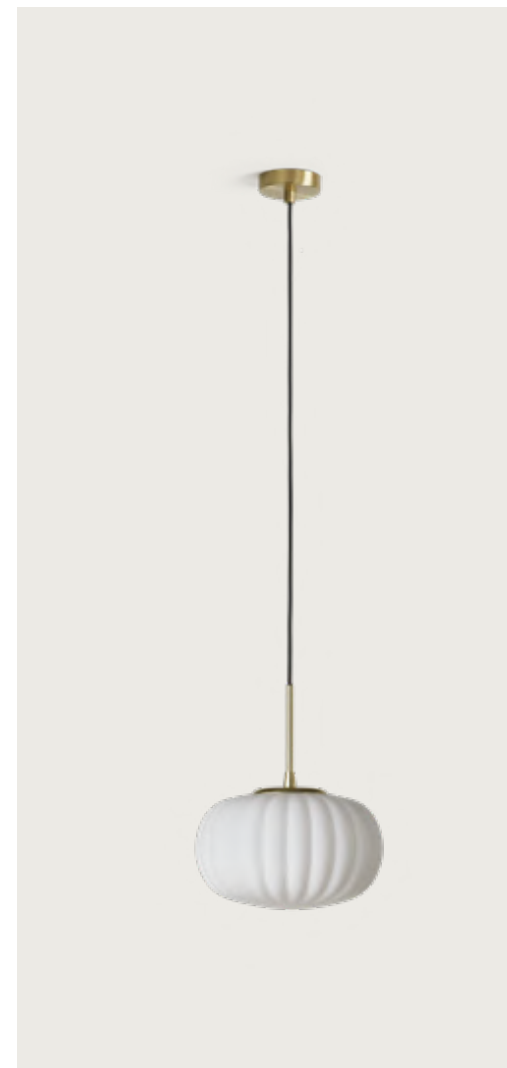

ATIL 405€ (+IVA)

Pendant lamp

C1281

Designed by Pepe Fornas, 2019

DESCRIPTION

MATERIALS
Steel / Glass

MATERIALES
Acero / Vidrio

FINISHES

Metal:
Matt Black
Matt Brass

ACABADOS

Metal:
Negro mate
Oro mate

Shade:
Opal

Pantalla:
Opal

SPECIFICATIONS

Bulbs G9 Led (Included)
5W - 2700K
220-240 V, 50/60 Hz
IP20, Class I

ESPECIFICACIONES

Bombillas G9 Led (Incluidas)
5W - 2700K
220-240 V, 50/60 Hz
IP20, Clase I

RECOMMENDED BULB

B005/5W

BOMBILLA RECOMENDADA





B005/5W

ENERGY LABEL

A ++

ETIQUETA ENERGÉTICA

A ++

⊕ IP20 CE    

TECHNICAL

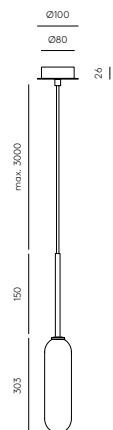

160



ATIL 2,415€ (+IVA)

Pendant lamp

C1281/6

Designed by Pepe Fornas, 2019

DESCRIPTION

MATERIALS
Steel / Glass

MATERIALES
Acero / Vidrio

FINISHES

Metal:
Matt Black
Matt Brass (details)

ACABADOS

Metal:
Negro mate
Oro mate (Detalles)

Shade:
Opal

Pantalla:
Opal

SPECIFICATIONS

Bulbs G9 Led (Included)
6x 5W - 2700K
220-240 V, 50/60 Hz
IP20, Class I

ESPECIFICACIONES

Bombillas G9 Led (Incluidas)
6x 5W - 2700K
220-240 V, 50/60 Hz
IP20, Clase I

RECOMMENDED BULB

B005/5W

BOMBILLA RECOMENDADA

B005/5W

ENERGY LABEL

A ++

ETIQUETA ENERGÉTICA

A ++

⊕ IP20 CE    

TECHNICAL

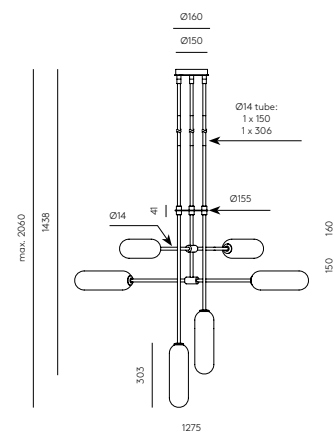

161





ATIL



London, United Kingdom

DALT 1,463€ (+IVA)

Pendant lamp

C1280/6

Designed by Pepe Fornas, 2019



DESCRIPTION

MATERIALS

Steel / Marble / Glass

FINISHES

Metal:
Matt Black / Aged Brass
Marble:
Black / Green
Shade:
Opal

POSSIBLE MODIFICATIONS

Marble finishes: White, black or green (extra cost)

SPECIFICATIONS

Bulbs G9 Led (Included)
6 x 5W - 2700K dimmable
220-240 V, 50/60 Hz
IP20, Class I

RECOMMENDED BULB

B005/5W

ENERGY LABEL

A ++



MATERIALES

Acero / Mármol / Vidrio

ACABADOS

Metal:
Negro mate / Oro envejecido
Mármol:
Negro / Verde
Pantalla:
Opal

MODIFICACIONES POSIBLES

Acabados Mármol: Blanco, negro o verde (coste extra)

ESPECIFICACIONES

Bombillas G9 Led (Incluidas)
6 x 5W - 2700K regulable
220-240 V, 50/60 Hz
IP20, Clase I

BOMBILLA RECOMENDADA

B005/5W

ETIQUETA ENERGÉTICA

A ++

TECHNICAL

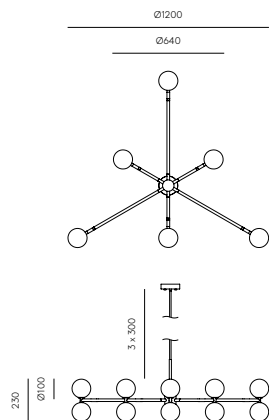

DALT 319€ (+IVA)

Pendant lamp

C1280

Designed by Pepe Fornas, 2019



DESCRIPTION

MATERIALS

Steel / Marble / Glass

FINISHES

Metal:
Matt Black / Aged Brass
Marble:
Black / Green / White
Shade:
Opal

SPECIFICATIONS

Bulb G9 Led (Included)
5W - 2700K dimmable
220-240 V, 50/60 Hz
IP20, Class I

RECOMMENDED BULB

B005/5W

ENERGY LABEL

A ++

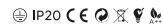

MATERIALES

Acero / Mármol / Vidrio

ACABADOS

Metal:
Negro mate / Oro envejecido
Mármol:
Negro / Verde / Blanco
Pantalla:
Opal

ESPECIFICACIONES

Bombilla G9 Led (Incluidas)
5W - 2700K regulable
220-240 V, 50/60 Hz
IP20, Clase I

BOMBILLA RECOMENDADA

B005/5W

ETIQUETA ENERGÉTICA

A ++

TECHNICAL

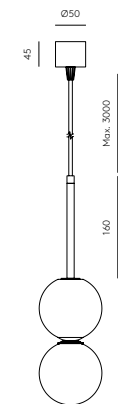

Zagreb, Croatia



FOCUS Negro Mate: 216€ (+IVA)
*Cabeza Alabastro: 63€ (+IVA) Pendant lamp
*Oro Preguntar por disponibilidad 265€ (+IVA)

C1279

Designed by Pepe Fornas, 2019



DESCRIPTION

MATERIALS

Steel / Aluminium or Alabaster

FINISHES

Body: Matt Black

Head: Aged gold, Anthracite, Matt black

POSSIBLE MODIFICATIONS

Alabaster head (Extra charge)

SPECIFICATIONS

Bulb GU10 Led (Included)
5W - 2700K
220-240 V, 50/60 Hz
IP20, Class I

RECOMMENDED BULB

B161

ENERGY LABEL

A ++



MATERIALES

Acero / Aluminio o Alabastro

ACABADOS

Cuerpo: Negro Mate

Cabeza: Oro envejecida, Antracita, Negro mate

MODIFICACIONES POSIBLES

Cabezal Alabastro (Sobrecoste)

ESPECIFICACIONES

Bombilla GU10 Led (Incluida)
5W - 2700K
220-240 V, 50/60 Hz
IP20, Clase I

BOMBILLA RECOMENDADA

B161

ETIQUETA ENERGÉTICA

A ++

TECHNICAL

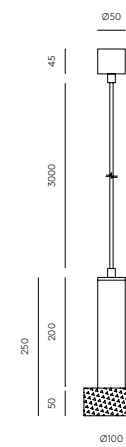

FOCUS

Antracita: 924 € (+IVA)
 Oro: 924€ (+IVA)
 Alabastro: 1,176€ (+IVA)

Pendant lamp

C1279/4

Designed by Pepe Fornas, 2020



DESCRIPTION

MATERIALS
 Steel / Aluminium or Alabaster

FINISHES
Body: Matt Black
Head: Aged gold, Anthracite, Matt black

POSSIBLE MODIFICATIONS
 Alabaster head (Extra charge)

SPECIFICATIONS
 Bulb GU10 Led (Included)
 4x 5W - 2700K
 220-240 V, 50/60 Hz
 IP20, Class I

RECOMMENDED BULB
 B161

ENERGY LABEL
 A ++

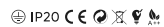

MATERIALES
 Acero / Aluminio o Alabastro

ACABADOS
Cuerpo: Negro Mate
Cabeza: Oro Viejo / Antracita / Negro mate

MODIFICACIONES POSIBLES
 Cabezal Alabastro (Sobrecoste)

ESPECIFICACIONES
 Bombilla GU10 Led (Incluida)
 4x 5W - 2700K
 220-240 V, 50/60 Hz
 IP20, Clase I

BOMBILLA RECOMENDADA
 B161

ETIQUETA ENERGÉTICA
 A ++

TECHNICAL

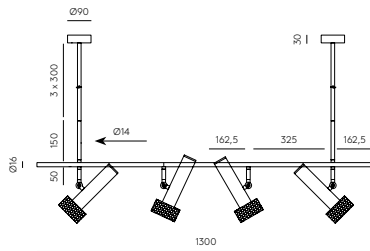

FOCUS

Antracita: 286 € (+IVA)
 Oro: 286€ (+IVA)
 Alabastro: 366€ (+IVA)

Pendant lamp

C1279/1

Designed by Pepe Fornas, 2019

DESCRIPTION

MATERIALS
 Steel / Aluminium or Alabaster

FINISHES
Body: Matt Black
Head: Aged gold, Anthracite, Matt black

POSSIBLE MODIFICATIONS
 Alabaster head (Extra charge)

SPECIFICATIONS
 Bulb GU10 Led (Included)
 5W - 2700K
 220-240 V, 50/60 Hz
 IP20, Class I

RECOMMENDED BULB
 B161

ENERGY LABEL
 A ++

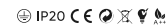

MATERIALES
 Acero / Aluminio o Alabastro

ACABADOS
Cuerpo: Negro Mate
Cabeza: Oro Viejo / Antracita / Negro mate

MODIFICACIONES POSIBLES
 Cabezal Alabastro (Sobrecoste)

ESPECIFICACIONES
 Bombilla GU10 Led (Incluida)
 5W - 2700K
 220-240 V, 50/60 Hz
 IP20, Clase I

BOMBILLA RECOMENDADA
 B161

ETIQUETA ENERGÉTICA
 A ++

TECHNICAL

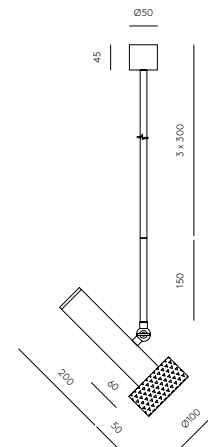

NOOI 289€ (+IVA)

C1276

Designed by Pepe Fornas, 2022

DESCRIPTION

MATERIALS

Linen / Steel / Acrylic

FINISHES

Metal:
Matt Black

Shade:
Cream Linen textile

Acrylic:
Opal

MATERIALES

Lino / Metal / Acrílico

ACABADOS

Metal:
Negro mate

Tulipa:
Textil Lino Crema

Acrílico:
Opal

TECHNICAL

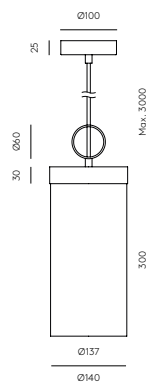

Cairo, Egypt

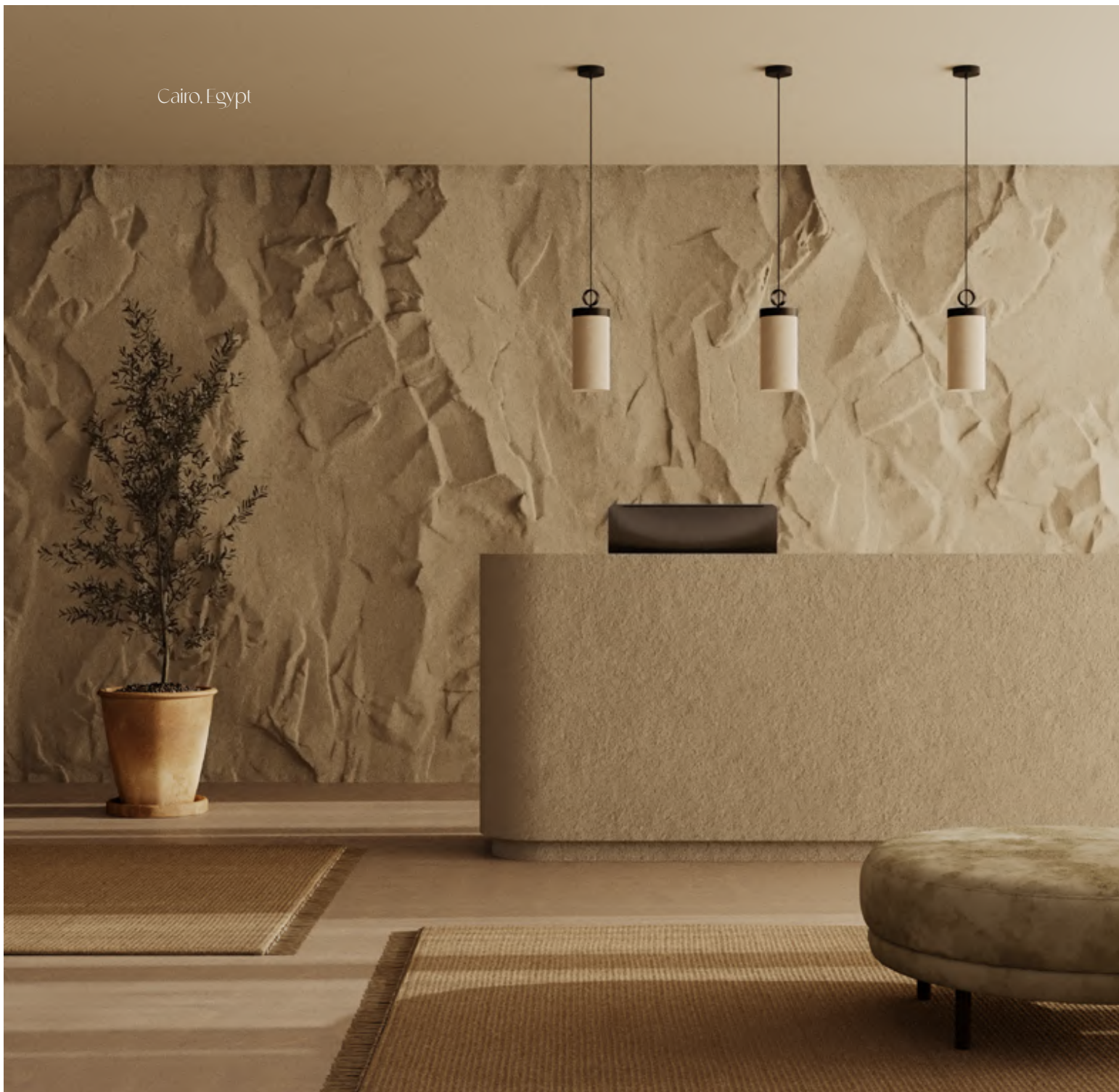



NINO 342€ (+IVA)

Pendant lamp

C1275

Designed by JF Sevilla, 2021

DESCRIPTION

MATERIALS

Steel / Optic Glass

FINISHES

Metal: Matt Black

Details: Matt Brass

Glass: Optic

SPECIFICATIONS

Led Chip x 7W (Included)

2700K TRIAC dimmable

24 V, 50/60 Hz

IP20, Class I

ENERGY LABEL

A ++

Ⓜ IP20 CE E U

MATERIALES

Acero / Vidrio Óptico

ACABADOS

Metal: Negro mate

Detalles: Oro mate

Vidrio: Óptico

ESPECIFICACIONES

Chip Led x 7W (Incluido)

2700K TRIAC regulable

24 V, 50/60 Hz

IP20, Clase I

ETIQUETA ENERGÉTICA

A ++

TECHNICAL

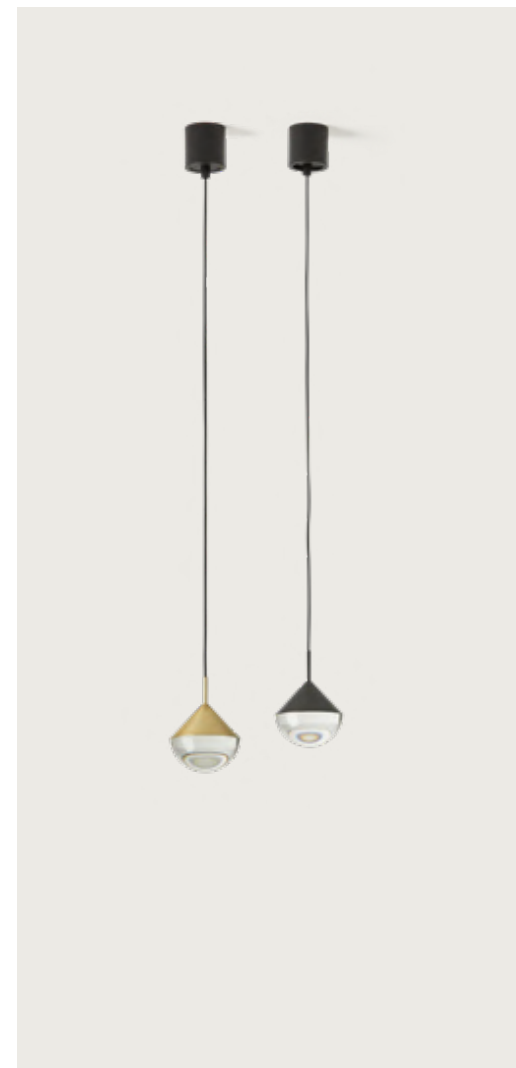
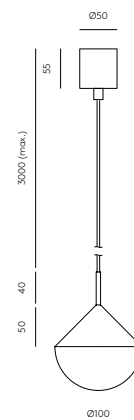

LYB Negro Mate: 886€ (+IVA)
Oro Mate: 986€ (+IVA)

Pendant lamp

C1274

Designed by Pepe Fornas, 2019



DESCRIPTION

MATERIALS
Steel

FINISHES

Metal:
Matt Black
Matt Brass

SPECIFICATIONS
5 x 5W Integrated Led
3000K
36-50 V, 50/60 Hz
IP20, Class I

ENERGY LABEL
A ++

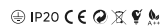

MATERIALES
Acero

ACABADOS

Metal:
Negro mate
Oro mate

ESPECIFICACIONES
5 x 5W Led integrado
3000K
36-50 V, 50/60 Hz
IP20, Clase I

ETIQUETA ENERGÉTICA
A ++

TECHNICAL

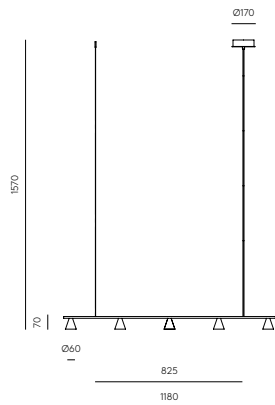

COLN 713€ (+IVA)

Pendant lamp

C1267

Designed by AC Studio, 2019

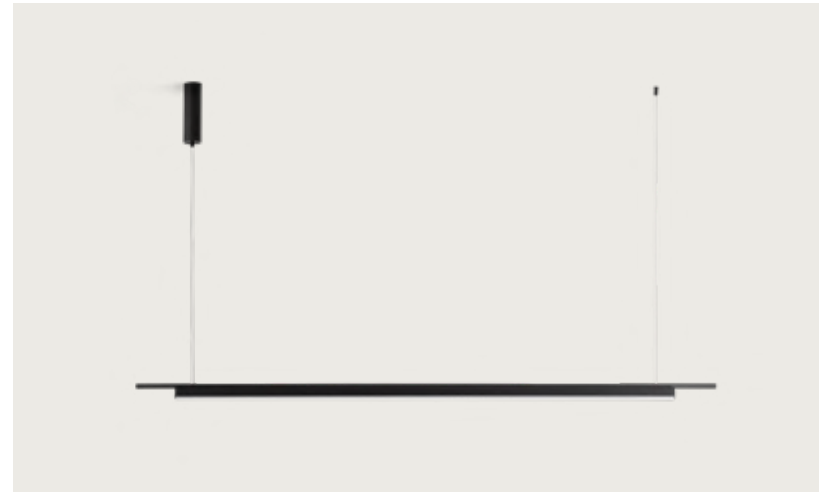

DESCRIPTION

MATERIALS
Steel / Acrylic

FINISHES

Metal:
Matt Black
Diffuser:
White

SPECIFICATIONS
LED strip 21W
2700K TRIAC dimmable
24 V, 50/60 Hz,
IP20, Class I

**ASK US FOR DIMMER
OPTIONS PRICE LIST**

ENERGY LABEL
A ++



MATERIALES
Acero / Acrílico

ACABADOS

Metal:
Negro mate
Difusor:
Blanco

ESPECIFICACIONES
LED strip 21W
2700K TRIAC dimmable
24 V, 50/60 Hz
IP20, Clase I

**CONSULTAR OPCIONES DE
REGULACIÓN EN TARIFA**

ETIQUETA ENERGÉTICA
A ++

TECHNICAL

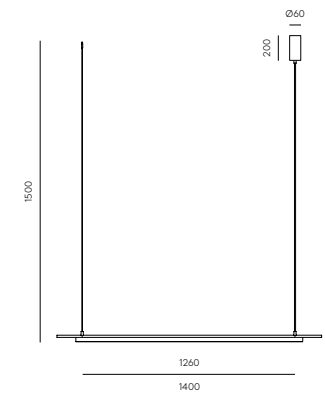

Torino, Italy



GAND 2,625€ (+IVA)

*Preguntar por disponibilidad

Pendant lamp

C1271

Designed by Pepe Fornas, 2019

DESCRIPTION

MATERIALS

Steel / Blown Glass

FINISHES

Metal:
Matt Black
Chrome
Matt Brass

Glass:
Opal
Clear

SPECIFICATIONS

20 x G4 Led 1,2W - 3000K
Bulbs and shades included
12 V, 50/60 Hz, IP20, Class I

ENERGY LABEL

A ++

IP20 CE ENEC

MATERIALES

Acero / Cristal Soplado

ACABADOS

Metal:
Negro Mate
Cromo
Oro Mate

Vidrio:
Opal
Transparente

ESPECIFICACIONES

20 x G4 Led 1,2W - 3000K
Bombillas y tulipas incluidas
12 V, 50/60 Hz, IP20, Clase I

ETIQUETA ENERGÉTICA

A ++

TECHNICAL

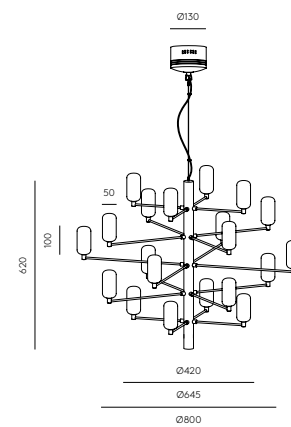

CLIP 763€ (+IVA)

Pendant lamp

C1265

Designed by Pepe Fornas, 2018

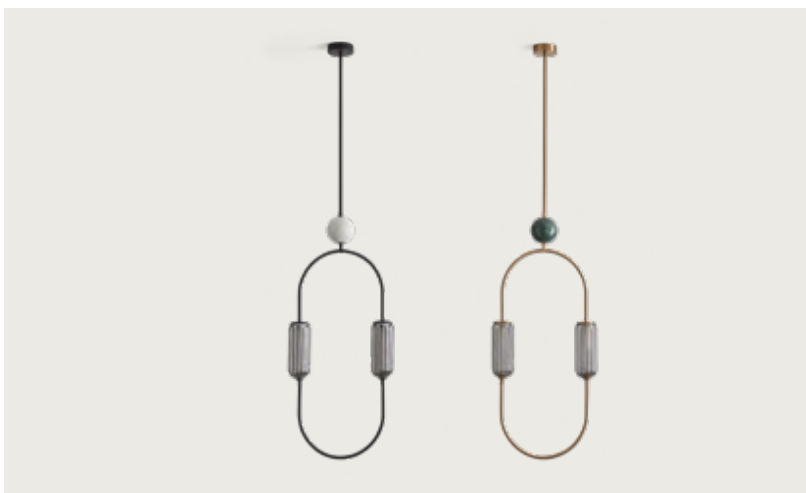

DESCRIPTION

MATERIALS

Steel / Marble / Blown Glass

FINISHES

Metal:
Matt Black
Aged Gold

Marble:
White
Green

Glass:
Smoked

SPECIFICATIONS

Bulb 2 x G9 Led (Included)
2 x 5W - 2700K
220-240 V, 50/60 Hz
IP20, Class I

RECOMMENDED BULB

B005/5W

ENERGY LABEL

A++

IP20 CE RoHS

TECHNICAL

MATERIALES

Acero / Mrmar / Vidrio Soplado

ACABADOS

Metal:
Negro Mate
Oro Envejecido

Mrmar:
Blanco
Verde

Vidrio:
Fum

ESPECIFICACIONES

Bombilla 2 x G9 Led (Incluida)
2 x 5W - 2700K
220-240 V, 50/60 Hz
IP20, Clase I

BOMBILLA RECOMENDADA

B005/5W

ETIQUETA ENERGTICA

A++

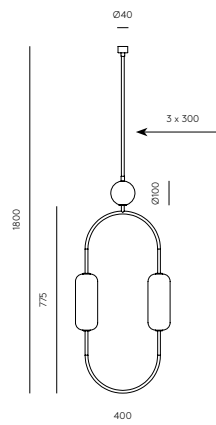



TERA 221€ (+IVA)

Pendant lamp

C1260

Designed by AC Studio, 2022

DESCRIPTION

MATERIALS

Steel

FINISHES

Metal:
Matt Brass
Matt black
Blued

SPECIFICATIONS

LED chip 8W - 3000K
Dimmable: TRIAC - DALI/PUSH
220-240V - 24V - 50/60Hz
IP20 - Class I

ENERGY LABEL

A ++

IP20 CE E U L

MATERIALES

Acero

ACABADOS

Metal:
Negro mate
Latón mate
Pavonado

ESPECIFICACIONES

Chip LED 8W - 3000K
Regulable: TRIAC - DALI/PUSH
220-240V - 24V - 50/60 Hz
IP20 - Clase I

ETIQUETA ENERGÉTICA

A ++

TECHNICAL

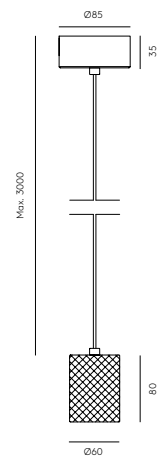

ABBACUS 1,509€ (+IVA)

Pendant lamp

C1258

Designed by Pepe Fornas, 2018



DESCRIPTION

MATERIALS

Steel / Glass

FINISHES

Metal:
Matt Black
Matt Brass

Glass:
Opal
Clear

SPECIFICATIONS

Bulb G9 Led (Included)
4 x 5W - 2700K
220-240 V, 50/60 Hz
IP20, Class I

RECOMMENDED BULB

B005/5W

ENERGY LABEL

A ++



MATERIALES

Acero / Vidrio

ACABADOS

Metal:
Negro Mate
Oro Mate

Vidrio:
Opal
Transparente

ESPECIFICACIONES

Bombilla G9 Led (Incluida)
4 x 5W - 2700K
220-240 V, 50/60 Hz
IP20, Clase I

BOMBILLA RECOMENDADA

B005/5W

ETIQUETA ENERGÉTICA

A ++

TECHNICAL

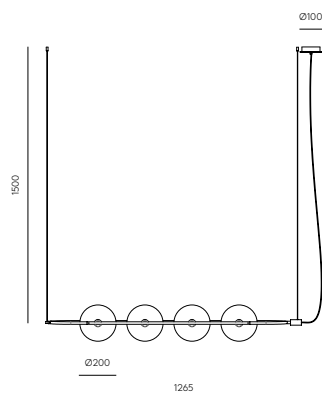

ABBACUS 569€ (+IVA)

Pendant lamp

C1258/1

Designed by Pepe Fornas, 2018

DESCRIPTION

MATERIALS

Steel / Glass

FINISHES

Metal:
Matt Black
Matt Brass

Glass:
Opal
Clear

SPECIFICATIONS

Bulb G9 Led (Included)
1 x 5W - 2700K
220-240 V, 50/60 Hz
IP20, Class I

RECOMMENDED BULB

B005/5W

ENERGY LABEL

A ++

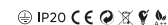

MATERIALES

Acero / Vidrio

ACABADOS

Metal:
Negro Mate
Oro Mate

Vidrio:
Opal
Transparente

ESPECIFICACIONES

Bombilla G9 Led (Incluida)
1 x 5W - 2700K
220-240 V, 50/60 Hz
IP20, Clase I

BOMBILLA RECOMENDADA

B005/5W

ETIQUETA ENERGÉTICA

A ++

TECHNICAL

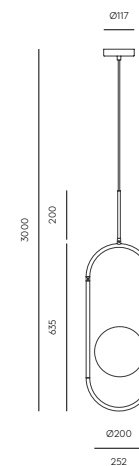

ERTO

Alabastro: 2,522€ (+IVA)

Cerámica: 2,015€ (+IVA)

Vidrio: 2,172€ (+IVA)

Acero: 2,067€ (+IVA)

C1257/5

Designed by Pepe Fornas, 2020

DESCRIPTION

MATERIALS

Steel

FINISHES

Metal:

Matt Black

Details:

Matt Brass

COMPATIBLE ACCESSORIES (INCLUDED)

Alabaster: 1096/25

Glass: 1223

Ceramic: 1097/20

Metal: 1038/25

Stripped Metal 1089/25

SPECIFICATIONS

5 x G9 LED 5W 2700K (Included)

220-240 V, 50/60 Hz

IP20, Class I

RECOMMENDED BULB

B005/5W

ENERGY LABEL

A ++

⊕ IP20 CE   

MATERIALES

Acero

ACABADOS

Metal:

Negro Mate

Detalles:

Oro Mate

ACCESORIOS COMPATIBLES (INCLUIDO)

Alabastro: 1096/25

Vidrio: 1223

Cerámica: 1097/20

Metal: 1038/25

Varillas Metal 1089/25

ESPECIFICACIONES

5 x G9 LED 5W 2700K (Incluidas)

220-240 V, 50/60 Hz

IP20, Clase I

BOMBILLA RECOMENDADA

B005/5W

ETIQUETA ENERGÉTICA

A ++

TECHNICAL

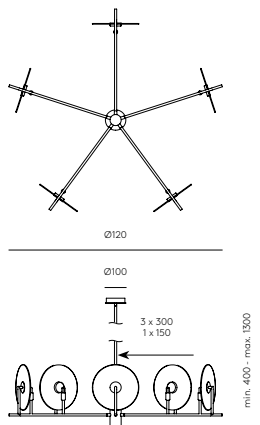

Vina del Mar, Chile



Madrid, Spain



FRAME 90cm: 1,194€ (+IVA)
120cm: 1,425€ (+IVA)
140cm: 1,714€ (+IVA)

Pendant lamp

C1246

Designed by AC Studio, 2018

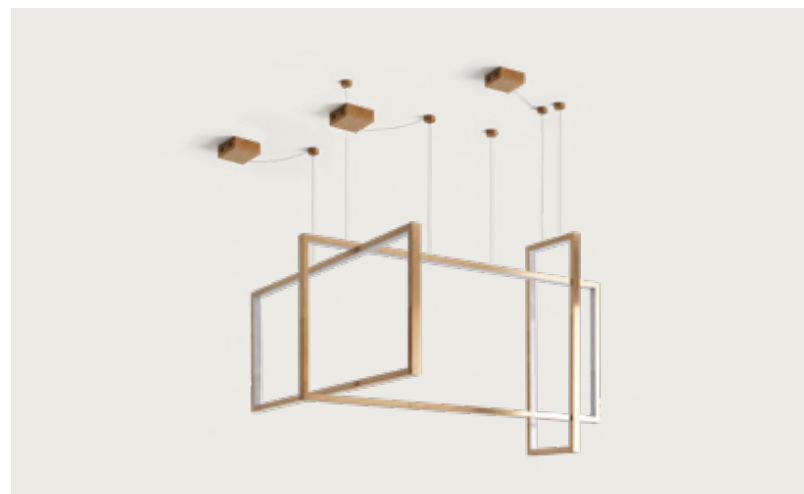

DESCRIPTION

MATERIALS

Steel

FINISHES

Metal:
Bronze
Matt Black

SIZES

1400 x 600 - 36W Led 3000K
1200 x 500 - 30W Led 3000K
900 x 300 - 22W Led 3000K

SPECIFICATIONS

24 V, 50/60 Hz, IP20, Class I

ASK US FOR DIMMER
OPTIONS PRICE LIST

RECOMMENDED BULB
B005/5W

SOLD INDIVIDUALLY

ENERGY LABEL

A ++



MATERIALES

Acero

ACABADOS

Metal:
Bronze
Negro Mate

ACABADOS

1400 x 600 - 36W Led 3000K
1200 x 500 - 30W Led 3000K
900 x 300 - 22W Led 3000K

ESPECIFICACIONES

24 V, 50/60 Hz, IP20, Clase I

CONSULTAR OPCIONES DE
REGULACIÓN EN TARIFA

BOMBILLA RECOMENDADA
B005/5W

SE VENDEN POR SEPARADO

ETIQUETA ENERGÉTICA

A ++

TECHNICAL

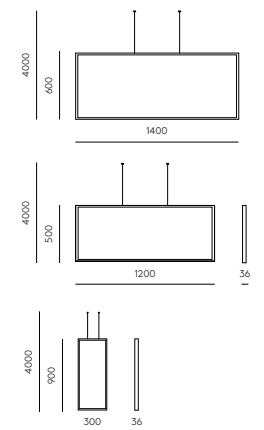

MAHO 1,222€ (+IVA)

Pendant lamp

C1254/6
Designed by JF Sevilla, 2021

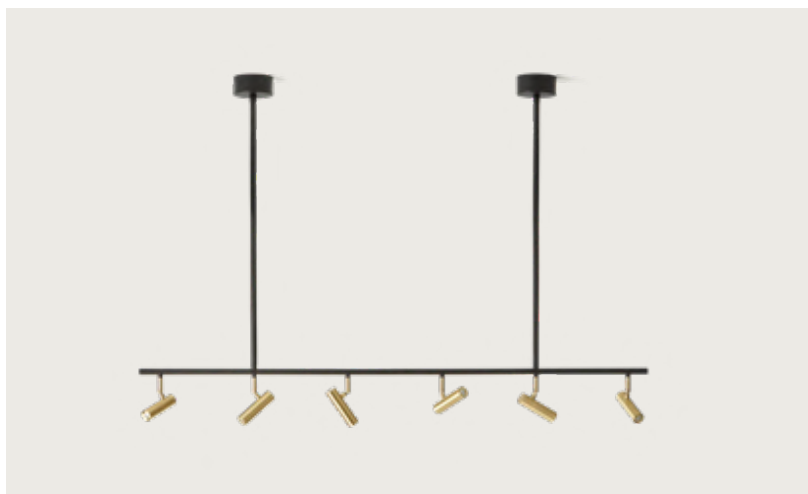

DESCRIPTION

MATERIALS
Steel

FINISHES
Metal:
Matt Black
Heads:
Matt Brass

SPECIFICATIONS
Integrated Led Cob 6x5W (Incluido)
3000K TRIAC Dimmable
230 V, 50/60 Hz
IP20, Class I

ENERGY LABEL
A ++

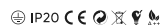

MATERIALES
Acero

ACABADOS
Metal:
Negro Mate
Cabezales:
Oro Mate

ESPECIFICACIONES
Led Cob integrado 6x5W (Incluido)
3000K TRIAC Regulable
230 V, 50/60 Hz
IP20, Clase I

ETIQUETA ENERGÉTICA
A ++

TECHNICAL

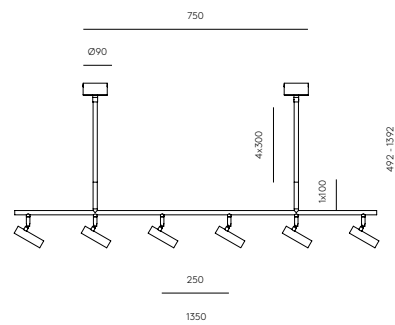

OHLALA Alabastro: 1,637€ (+IVA) Cerámica: 1,231€ (+IVA) Vidrio: 1,357€ (+IVA) Acero: 1,203€ (+IVA)

Pendant lamp

C1242
Designed by AC Studio, 2018

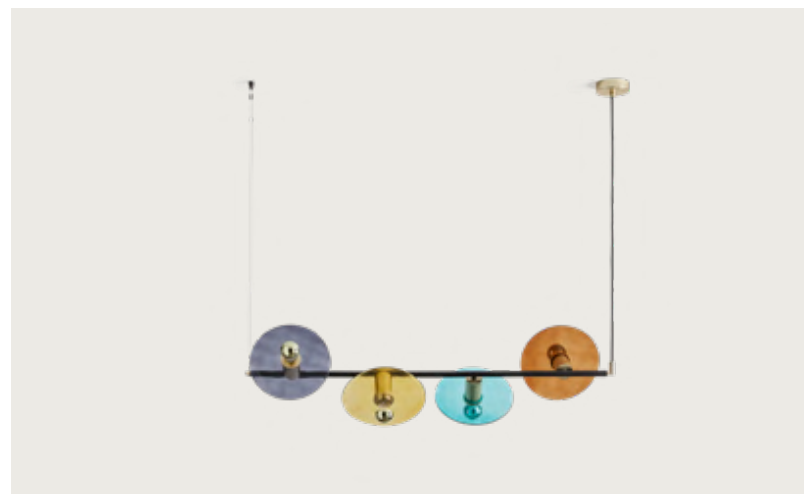

DESCRIPTION

MATERIALS
Steel

FINISHES
Metal:
Matt Black
Lampholders:
Matt Brass

IMAGE COMPOSITION
Accessory 1223/25
Bulb B038/GOLD (Not included)

SPECIFICATIONS
4 x E27 Max. 60W (Not included)
220-240 V, 50/60 Hz
IP20, Class I

COMPATIBLE ACCESSORIES
Ø Max. 25cm
More options in page

ENERGY LABEL
A ++



MATERIALES
Acero

ACABADOS
Metal:
Negro Mate
Portalámparas:
Oro Mate

COMPOSICION IMAGEN
Accesorio 1223/25
Bombilla B038/ORO (No incluidos)

ESPECIFICACIONES
4 x E27 Max. 60W (No incluida)
220-240 V, 50/60 Hz
IP20, Clase I

ACCESORIOS COMPATIBLES
Ø Máx 25cm
Más opciones en pág.

ETIQUETA ENERGÉTICA
A ++

TECHNICAL

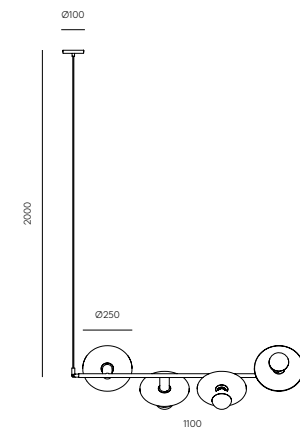

CRANE 1,015€ (+IVA)

Pendant lamp

C1241

Designed by JF Sevilla, 2017



DESCRIPTION

MATERIALS

Steel / Blown Glass

FINISHES

Metal:
Matt Black
Matt Brass

Glass:
Opal

SPECIFICATIONS

E27 Max. 60W (Not included)
G4 2 x 3W - 2700K (Included)
220-240 V, 50/60 Hz
IP20, Class I

RECOMMENDED BULB

B211 (7, 9, 11W) E27

ENERGY LABEL

A ++



MATERIALES

Acero / Vidrio Soplado

ACABADOS

Metal:
Negro Mate
Oro Mate

Vidrio:
Opal

ESPECIFICACIONES

E27 Max. 60W (No incluida)
G4 2 x 3W - 2700K (Incluidas)
220-240 V, 50/60 Hz
IP20, Clase I

BOMBILLA RECOMENDADA

B211 (7, 9, 11W) E27

ETIQUETA ENERGÉTICA

A ++

TECHNICAL

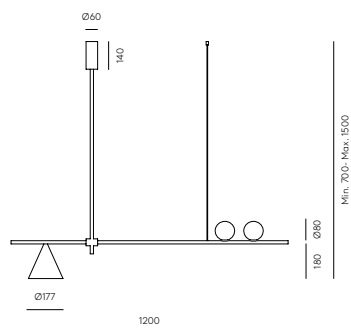

190

LUCA 216€ (+IVA)

Pendant lamp

C1238

Designed by AC Studio, 2017

DESCRIPTION

MATERIALS

Steel / Acrylic

FINISHES

Metal:
Matt Black

Acrylic:
Clear

SPECIFICATIONS

E27 Max. 60W (Not included)
220-240 V, 50/60 Hz
IP20, Class I

RECOMMENDED BULB

B211 (7, 9, 11W)

ENERGY LABEL

A ++



MATERIALES

Acero / Acrílico

ACABADOS

Metal:
Negro Mate

Acrílico:
Transparente

ESPECIFICACIONES

E27 Max. 60W (No incluida)
220-240 V, 50/60 Hz
IP20, Clase I

BOMBILLA RECOMENDADA

B211 (7, 9, 11W)

ETIQUETA ENERGÉTICA

A ++

TECHNICAL

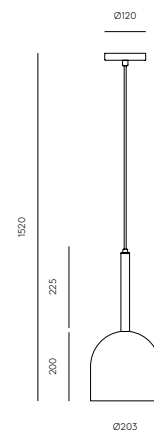

191

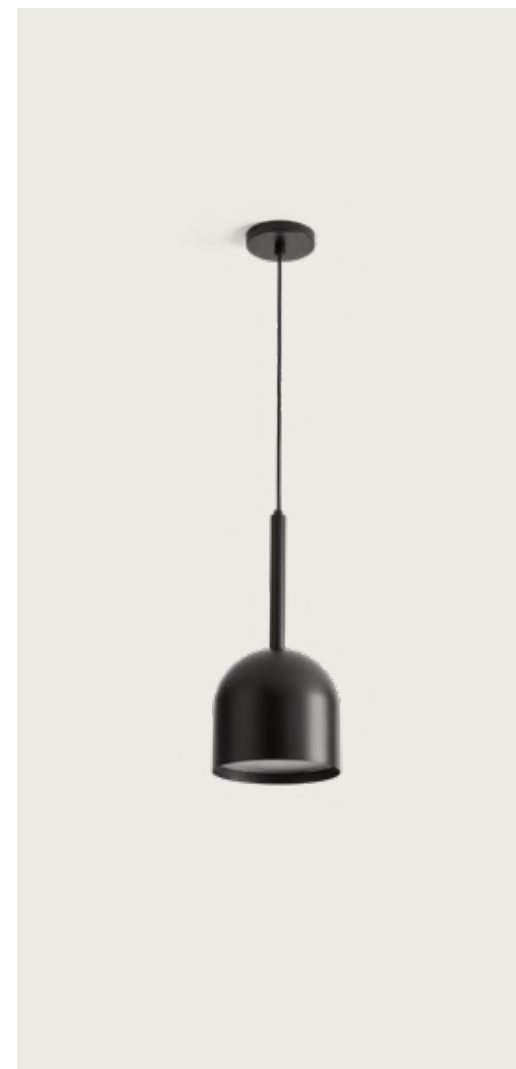

LUCA + 636€ (+IVA)

C1239/3

Designed by AC Studio, 2017

DESCRIPTION

MATERIALS

Steel

FINISHES

Metal:
Matt Black

SPECIFICATIONS

3x E27 Max. 60W (Not included)
220-240 V, 50/60 Hz
IP20, Class I

RECOMMENDED BULB

B211 (7, 9, 11W)

ENERGY LABEL

A ++

MATERIALES

Acero

ACABADOS

Metal:
Negro Mate

ESPECIFICACIONES

3x E27 Max. 60W (No incluida)
220-240 V, 50/60 Hz
IP20, Clase I

BOMBILLA RECOMENDADA

B211 (7, 9, 11W)

ETIQUETA ENERGÉTICA

A ++

⊕ IP20 CE    

TECHNICAL

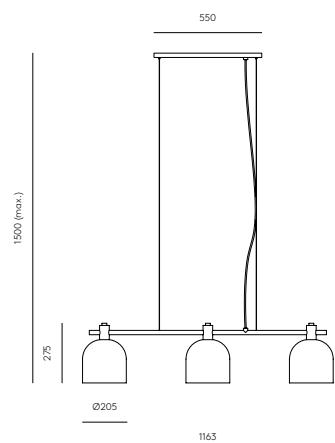

192



San Francisco, USA



LOTA 252€ (+IVA)

C1235

Designed by Pepe Fornas, 2021

DESCRIPTION

MATERIALS

Steel / Blown Glass

FINISHES

Metal:

Matt Black

Glass Shade:

Clear

SPECIFICATIONS

Integrated 9W LED, 3000K

TRIAC Dimmable

24V, 50/60 HZ

IP20, CLASE I

ENERGY LABEL

A ++

IP20 CE ENEC

MATERIALES

Acero / Vidrio Soplado

ACABADOS

Metal:

Negro Mate

Tulipa Vidrio:

Transparente

ESPECIFICACIONES

Placa LED 9W integrada 3000K

TRIAC Regulable

24V, 50/60 Hz

IP20, Clase I

ETIQUETA ENERGÉTICA

A ++

TECHNICAL

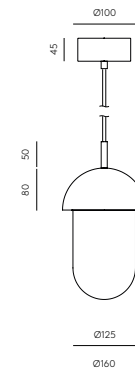

LITA 210€ (+IVA)

Pendant lamp

C1230

Designed by Pepe Fornas, 2020

DESCRIPTION

MATERIALS
Steel / Wood

FINISHES

Metal:
Matt Black
Wood:
Black

SPECIFICATIONS

Integrated Led Cob
3W 3000K (Incluida)
12V / 220-240 V, 50/60 Hz

ENERGY LABEL

A ++

MATERIALES
Acero / Madera

ACABADOS

Metal:
Negro Mate
Madera:
Negro

ESPECIFICACIONES

Cob Led Integrado
3W 3000K (Incluida)
12V / 220-240 V, 50/60 Hz

ETIQUETA ENERGÉTICA

A ++

IP20 CE E

TECHNICAL

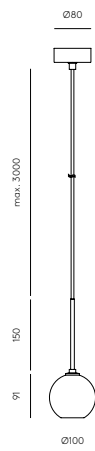

LITA 804€ (+IVA)

Pendant lamp

C1230 /4

Designed by Pepe Fornas, 2020



DESCRIPTION

MATERIALS
Steel / Wood

FINISHES

Metal:
Matt Black
Wood:
Walnut
Black

SPECIFICATIONS

4 x Integrated Led Cob
3W 3000K (Incluida)
12V / 220-240 V, 50/60 Hz

ENERGY LABEL

A ++

IP20 CE E

MATERIALES
Acero / Madera

ACABADOS

Metal:
Negro Mate
Madera:
Nogal
Negro

ESPECIFICACIONES

4 x Cob Led Integrado
3W 3000K (Incluida)
12V / 220-240 V, 50/60 Hz

ETIQUETA ENERGÉTICA

A ++

TECHNICAL

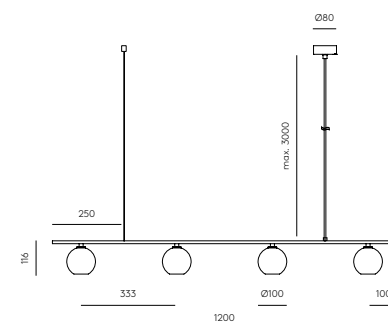

NERA SIX 1,001€ (+IVA)

Pendant lamp

C1229/6

Designed by AC Studio, 2021



DESCRIPTION

MATERIALS
Steel / Acrylic

FINISHES

Metal:
Matt Black
Heads:
Matt Black

SPECIFICATIONS

Integrated Led Cob 6x8W
(incluido)
3000K, 230V - 24V, 50/60 Hz
IP20, Class I

ENERGY LABEL

A ++

IP20 CE RoHS ENEC

MATERIALES
Acero / Acrílico

ACABADOS

Metal:
Negro Mate
Cabezales:
Negro Mate

ESPECIFICACIONES

Led Cob integrado 6x8W
(incluido)
3000K, 230V - 24V, 50/60 Hz
IP20, Clase I

ETIQUETA ENERGÉTICA

A ++

TECHNICAL

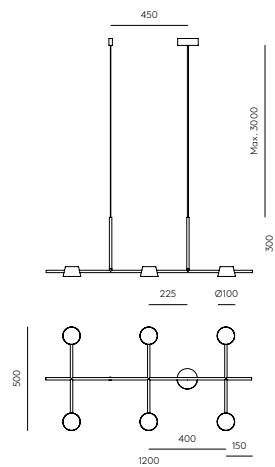

198

NERA 186€ (+IVA)

Pendant lamp

C1229

Designed by Pepe Fornas, 2020

DESCRIPTION

MATERIALS
Steel / Acrylic

FINISHES

Metal:
Matt Black
Head:
Matt Black

SPECIFICATIONS

Integrated Led Cob 8W
(incluido)
3000K, 230V - 24V, 50/60 Hz
IP20, Class I

ENERGY LABEL

A ++

IP20 CE RoHS ENEC

MATERIALES
Acero / Acrílico

ACABADOS

Metal:
Negro Mate
Cabezal:
Negro Mate

ESPECIFICACIONES

Led Cob integrado 8W
(incluido)
3000K, 230V - 24V, 50/60 Hz
IP20, Clase I

ETIQUETA ENERGÉTICA

A ++

TECHNICAL

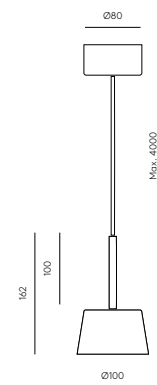

199

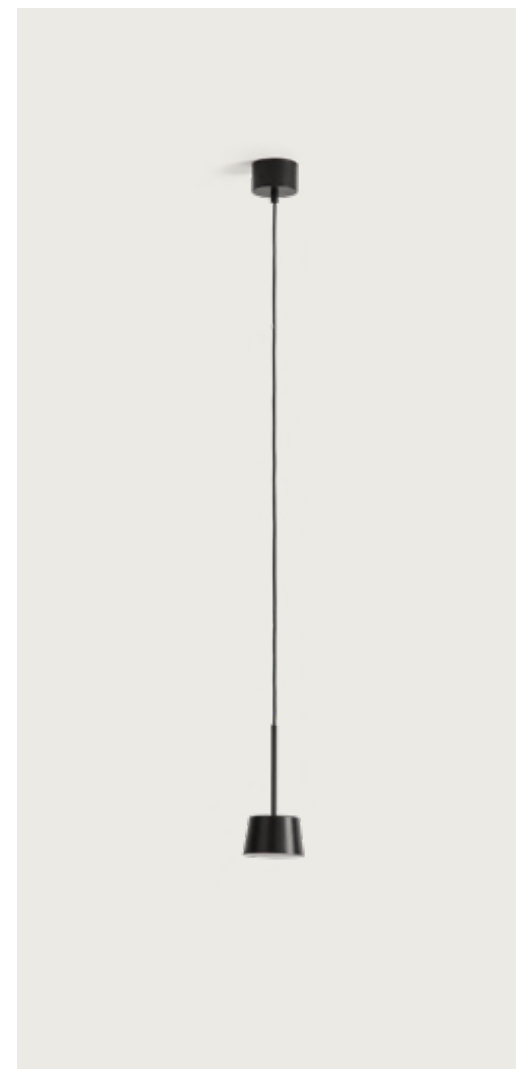



DORA 427€ (+IVA)

Pendant lamp

C1228

Designed by Jana Chang, 2016

DESCRIPTION

MATERIALS

Steel / Optic Glass

FINISHES

Metal:

Shiny Gold

Canopy / Cable:

Matt Black

OPTIONS

B033 (Standard) Opal

B034/Cob Clear

SPECIFICATIONS

Integrated Led

6,5W - 3000K

12 V, 50/60 Hz

IP20, Class I

ENERGY LABEL

A ++

MATERIALES

Acero / Cristal Óptico

ACABADOS

Metal:

Oro brillo

Florón / Cable:

Negro Mate

OPCIONES

B033 (Estándar) Opal

B034/Cob Transparente

ESPECIFICACIONES

Led integrado

6,5W - 3000K

12 V, 50/60 Hz

IP20, Clase I

ETIQUETA ENERGÉTICA

A ++

IP20 CE RoHS WEEE

TECHNICAL

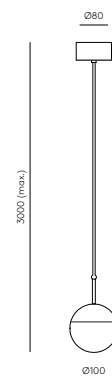

ALOA 245€ (+IVA)

Pendant lamp

C1227

Designed by Fornasevi, 2016

DESCRIPTION

MATERIALS

Steel

FINISHES

Metal: Matt Black

Diffuser: Shiny Gold

RECOMMENDED BULB

B038/GOLD

SPECIFICATIONS

E27 Max. 60W
(Not included)
220-240 V, 50/60 Hz
IP20, Class I

ENERGY LABEL

A ++

⊕ IP20 CE    

MATERIALES

Acero

ACABADOS

Metal: Negro Mate

Diffusor: Oro Brillo

BOMBILLA RECOMENDADA

B038/ORO

ESPECIFICACIONES

E27 Max. 60W
(No incluida)
220-240 V, 50/60 Hz
IP20, Clase I

ETIQUETA ENERGÉTICA

A ++

TECHNICAL

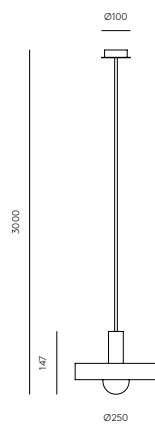

202

ALOA 1,131€ (+IVA)

Pendant lamp

C1227/4

Designed by Fornasevi, 2016

DESCRIPTION

MATERIALS

Steel

FINISHES

Metal: Matt Black

Diffuser: Shiny Gold

RECOMMENDED BULB





B038/GOLD

SPECIFICATIONS

4 x E27 Max. 60W
(Not included)
220-240 V, 50/60 Hz
IP20, Class I

ENERGY LABEL

A ++

⊕ IP20 CE    



DESCRIPTION

MATERIALS

Steel

FINISHES

Metal: Matt Black

Diffuser: Shiny Gold

RECOMMENDED BULB



B038/GOLD

SPECIFICATIONS

4 x E27 Max. 60W
(Not included)
220-240 V, 50/60 Hz
IP20, Class I

ENERGY LABEL

A ++

⊕ IP20 CE    



DESCRIPTION

MATERIALES

Acero

ACABADOS

Metal: Negro Mate

Diffusor: Oro Brillo

BOMBILLA RECOMENDADA

B038/ORO

ESPECIFICACIONES

4 x E27 Max. 60W
(No incluida)
220-240 V, 50/60 Hz
IP20, Clase I

ETIQUETA ENERGÉTICA

A ++

⊕ IP20 CE    

TECHNICAL

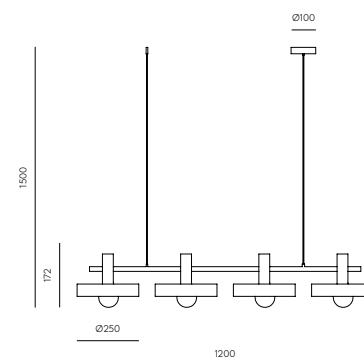

203

DELIE

Negro Mate, Mármol blanco: 261€ (+IVA)
 Oro Envejecido, Mármol negro: 270€ (+IVA) Pendant lamp

C1224
 Designed by JF Sevilla, 2020

DESCRIPTION

MATERIALS

Steel / Blown Glass / Marble

FINISHES

Metal: Matt Black
Marble: White
 Aged Gold Black

Glass: Opal

RECOMMENDED BULB
 B005/5W

SPECIFICATIONS

G9 LED Bulbs (Included)
 5W 2700K, 220-240 V,
 50/60 Hz, IP20, Class I

ENERGY LABEL
 A ++



MATERIALES

Acero / Vidrio Soplado / Mármol

ACABADOS

Metal: Negro Mate
Mármol: Blanco
 Oro Envejecido Negro

Cristal: Opal

BOMBILLA RECOMENDADA
 B005/5W

ESPECIFICACIONES

Bombillas G9 LED (Incluidas)
 5W 2700K, 220-240 V,
 50/60 Hz, IP20, Clase I

ETIQUETA ENERGÉTICA
 A ++



TECHNICAL



DELIE

Negro Mate, Mármol blanco: 1,617€ (+IVA)
 Oro Envejecido, Mármol negro: 1,694€ (+IVA) Pendant lamp

C1224/8
 Designed by JF Sevilla, 2020



DESCRIPTION

MATERIALS

Steel / Blown Glass / Marble

FINISHES

Metal: Matt Black
Marble: White
 Aged Gold Black

Glass: Opal

RECOMMENDED BULB
 B005/5W

SPECIFICATIONS

8 x G9 LED Bulbs (Included)
 5W 2700K, 220-240 V,
 50/60 Hz, IP20, Class I

ENERGY LABEL
 A ++

MATERIALES

Acero / Vidrio Soplado / Mármol

ACABADOS

Metal: Negro Mate
Mármol: Blanco
 Oro Envejecido Negro

Cristal: Opal

BOMBILLA RECOMENDADA
 B005/5W

ESPECIFICACIONES

8 x Bombillas G9 LED (Incluidas)
 5W 2700K, 220-240 V,
 50/60 Hz, IP20, Clase I

ETIQUETA ENERGÉTICA
 A ++

TECHNICAL

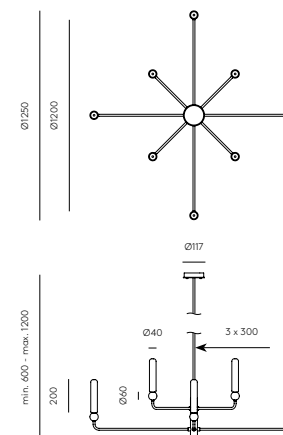

FEST 1,127€ (+IVA)

Pendant lamp

C1223

Designed by JF Sevilla, 2016



DESCRIPTION

MATERIALS

Steel / Glass / Fabric Cable

FINISHES

Metal:
Matt Black
Cable:
Black
Copper

COLOR GLASS (INCLUDED)

Turquoise, amber, pink, dark blue & brown. More options on page.

RECOMMENDED BULB

B038/GOLD

SPECIFICATIONS

6 x E27 Max. 60W (Not included)
220-240 V, 50/60 Hz, IP20, Class I

ENERGY LABEL

A ++



MATERIALES

Acero / Vidrio / Cable textil

ACABADOS

Metal:
Negro Mate
Cable:
Negro
Cobre

COLOR CRISTAL (INCLUIDOS)

Turquesa, ámbar, rosa, azul oscuro y marrón. Más opciones en pág.362.

BOMBILLA RECOMENDADA

B038/ORO

ESPECIFICACIONES

6 x E27 Max. 60W (No incluida)
220-240 V, 50/60 Hz, IP20, Clase I

ETIQUETA ENERGÉTICA

A ++

TECHNICAL

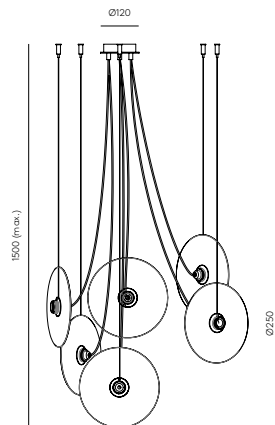

HELMET 280€ (+IVA)

Pendant lamp

C1221

Designed by Pepe Fornas, 2016

DESCRIPTION

MATERIALS

Steel / Blown Glass

FINISHES

Metal:
Shiny Gold / Matt Brass / Matt Black / Chrome

BULB INCLUDED

B034/COB
B033/COB

SPECIFICATIONS

E27-B033/COB (opal) included
3W - 3000K, 220-240 V,
50/60 Hz, IP20, Class I

ENERGY LABEL

A ++



MATERIALES

Acero / Vidrio Soplado

ACABADOS

Metal:
Oro Brillo / Oro Mate / Negro Mate / Cromo

BOMBILLA INCLUIDA

B034/COB
B033/COB

ESPECIFICACIONES

E27 - B033/COB (opal) incluida
3W - 3000K, 220-240 V,
50/60 Hz, IP20, Clase I

ETIQUETA ENERGÉTICA

A ++

TECHNICAL

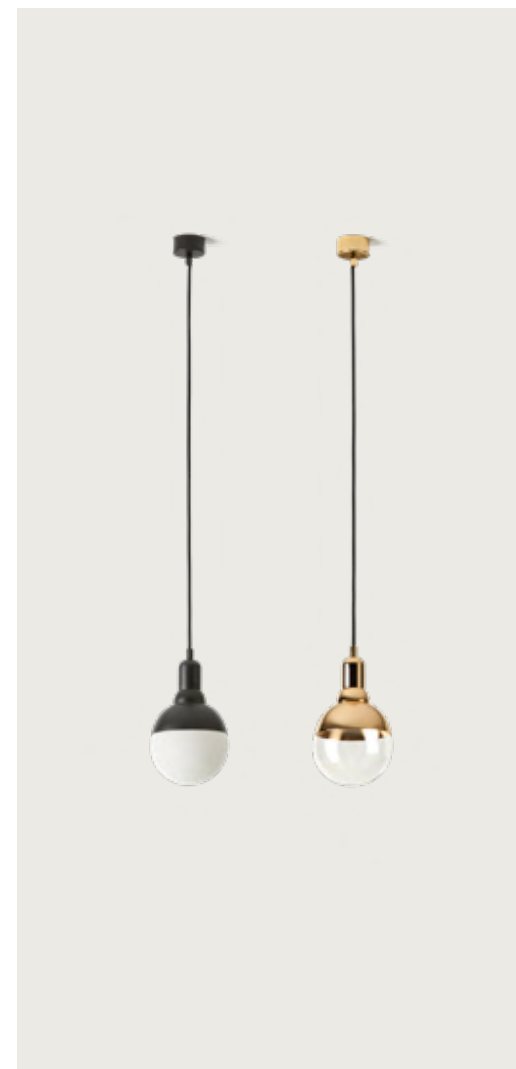
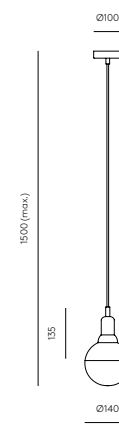

YOYO 867€ (+IVA)

C1222

Designed by Pepe Fornas, 2016

DESCRIPTION

MATERIALS

Steel

FINISHES

Metal:
Matt Black

Difusor:

Shiny Gold / Chrome /
Matt Black / Matt White

RECOMMENDED BULB

B005

SPECIFICATIONS

G9 Led Bulbs (Included)
3 x 3W - 3000K
220-240 V, 50/60 Hz
IP20, Class I

ENERGY LABEL

A ++

MATERIALES

Acero

ACABADOS

Metal:
Negro Mate

Difusor:

Oro Brillo / Cromo /
Negro Mate / Blanco Mate

BOMBILLA RECOMENDADA

B005

ESPECIFICACIONES

Bombillas G9 Led (Incluida)
3 x 3W - 3000K
220-240 V, 50/60 Hz
IP20, Clase I

ETIQUETA ENERGÉTICA

A ++

IP20 CE RoHS

TECHNICAL

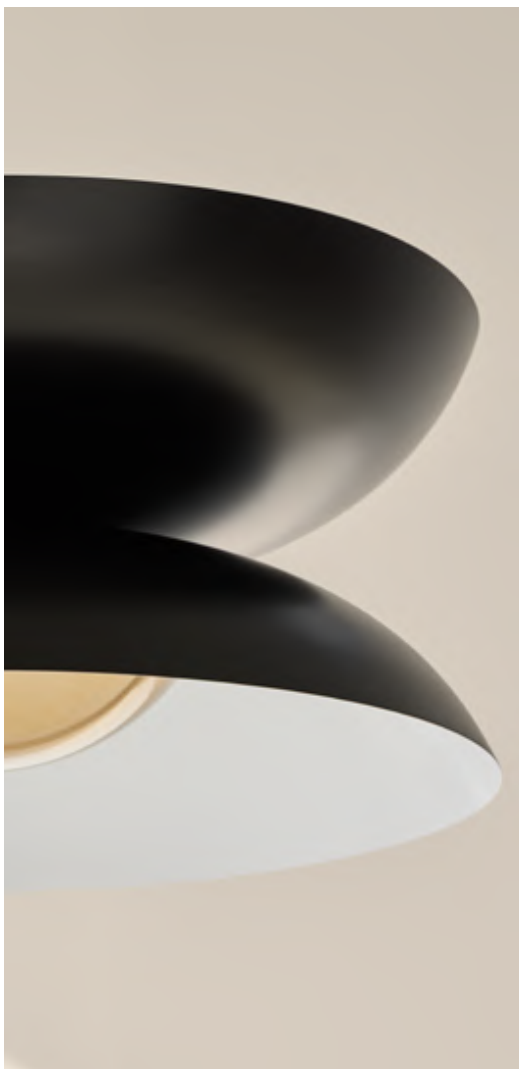
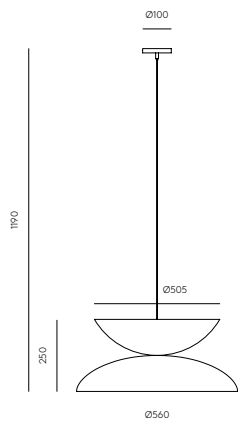

Tel Aviv-Yafo, Israel



Puerto Escondido, México



LIND 242€ (+IVA)

Pendant lamp

C1220

Designed by Agus Gascón, 2020

DESCRIPTION

MATERIALS

Steel / Alabaster

FINISHES

Metal:
Matt Brass

Shade:
Alabaster

RECOMMENDED BULB

B005/5W

SPECIFICATIONS

G9 Led Bulb (Included)

5W - 2700K

220-240 V, 50/60 HZ

IP20, Class I

ENERGY LABEL

A ++

IP20 CE RoHS RECYCLED

MATERIALES

Acero / Alabastro

ACABADOS

Metal:
Oro Mate

Túlipa:
Alabastro

BOMBILLA RECOMENDADA

B005/5W

ESPECIFICACIONES

Bombilla G9 Led (Incluida)

5W - 2700K

220-240 V, 50/60 HZ

IP20, Clase I

ETIQUETA ENERGÉTICA

A ++

TECHNICAL

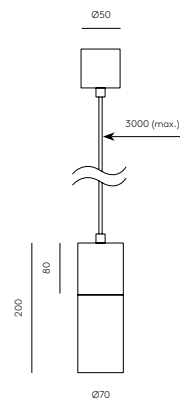

BALL Negro Mate: 328€ (+IVA)
Oro Mate: 394€ (+IVA)

Pendant lamp

C1215

Designed by AC Studio, 2017

DESCRIPTION

MATERIALS

Steel / Blown Glass

FINISHES

Metal:
Matt Black
Matt Brass

Vidrio:
Opal
Clear

RECOMMENDED BULB

B005 /5W

SPECIFICATIONS

G9 Led Bulbs (Included)
5W - 2700K
220-240 V, 50/60 Hz
IP20, Class I

ENERGY LABEL

A ++

IP20 CE ENEC RoHS LF

MATERIALES

Acero / Vidrio Soplado

ACABADOS

Metal:
Negro Mate
Oro Mate

Cristal:
Opal
Transparente

BOMBILLA RECOMENDADA

B005 /5W

ESPECIFICACIONES

Bombillas G9 Led (Incluida)
5W - 2700K
220-240 V, 50/60 Hz
IP20, Clase I

ETIQUETA ENERGÉTICA

A ++

TECHNICAL

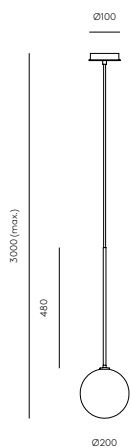

ATOM Negro Mate: 2,022€ (+IVA)
Oro Mate: 2,258€ (+IVA)

Pendant lamp

C1214/8
Designed by AC Studio, 2016



DESCRIPTION

MATERIALS
Steel / Blown Glass

FINISHES

Metal:
Matt Black
Matt Brass

Vidrio:
Opal
Clear

RECOMMENDED BULB
B005 /5W

SPECIFICATIONS

G9 Led Bulbs (Included)
8 x 5W - 2700K
220-240 V, 50/60 Hz
IP20, Class I

ENERGY LABEL
A ++

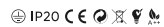

MATERIALES

Acero / Vidrio Soplado

ACABADOS

Metal:
Negro Mate
Oro Mate

Cristal:
Opal
Transparente

BOMBILLA RECOMENDADA
B005 /5W

ESPECIFICACIONES

Bombillas G9 Led (Incluida)
8 x 5W - 2700K
220-240 V, 50/60 Hz
IP20, Clase I

ETIQUETA ENERGÉTICA
A ++

TECHNICAL

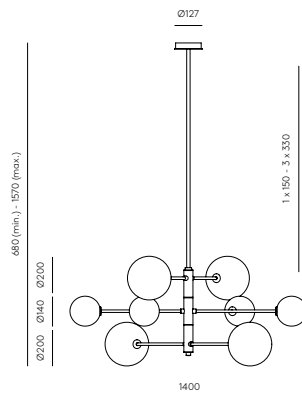

CUBE · X 44cm: 1,059€ (+IVA)
60cm: 1,094€ (+IVA)
65cm: 1,656€ (+IVA)

Pendant lamp

C1213
Designed by AC Studio, 2016



DESCRIPTION

MATERIALS
Steel

FINISHES

Metal:
Chrome
Shiny Gold

SIZES

44 X 44 X 44 - 40W LED 3000K
60 X 40 X 35 - 45W LED 3000K
65 X 65 X 65 - 55W LED 3000K
90 X 90 X 90 - 75W LED 3000K

SPECIFICATIONS

Strip Led - 24 V, 50/60 Hz
IP20, Class I

ENERGY LABEL
A ++

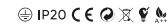

MATERIALES

Acero

ACABADOS

Metal:
Cromo
Oro brillo

BOMBILLA RECOMENDADA

44 X 44 X 44 - 40W LED 3000K
60 X 40 X 35 - 45W LED 3000K
65 X 65 X 65 - 55W LED 3000K
90 X 90 X 90 - 75W LED 3000K

ESPECIFICACIONES

Tira Led - 24 V, 50/60 Hz
IP20, Clase I

ETIQUETA ENERGÉTICA
A ++

TECHNICAL

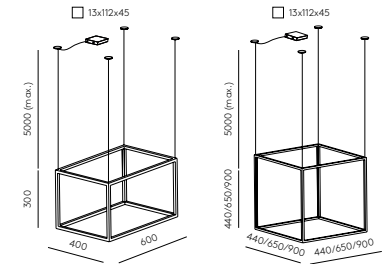

MIKA 196€ (+IVA)

Pendant lamp

C1204

Designed by AC Studio, 2016



DESCRIPTION

MATERIALS

Steel

FINISHES

Canopy, ring and cable:
Black

Body:

Matt black
Matt White
Shiny Gold
Bronze

SPECIFICATIONS

Integrated COB Led
3W - 2700K TRIAC dimmable
24V, 50/60 Hz
IP20, Class I

ENERGY LABEL

A ++

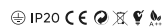

MATERIALES

Acero

ACABADOS

Floron, aro y cable:
Negro

Cuerpo:

Negro mate
Blanco mate
Oro brillo
Bronze

ESPECIFICACIONES

Led COB integrado
3W - 2700K TRIAC regulable
24V, 50/60 Hz
IP20, Clase I

ETIQUETA ENERGÉTICA

A ++

TECHNICAL

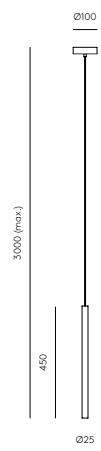

MIKA MULTI 1,672€ (+IVA)

Pendant lamp

C1204/8

Designed by AC Studio, 2016



DESCRIPTION

MATERIALS

Steel

FINISHES

Canopy, ring and cable:
Black

Body:

Matt black
Matt White
Shiny Gold
Bronze

SPECIFICATIONS

Integrated COB Led
8 x 3W - 2700K TRIAC dimmable
24V, 50/60 Hz
IP20, Class I

ENERGY LABEL

A ++

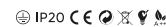

MATERIALES

Acero

ACABADOS

Floron, aro y cable:
Negro

Cuerpo:

Negro mate
Blanco mate
Oro brillo
Bronze

ESPECIFICACIONES

Led COB integrado
8 x 3W - 2700K TRIAC regulable
24V, 50/60 Hz
IP20, Clase I

ETIQUETA ENERGÉTICA

A ++

TECHNICAL

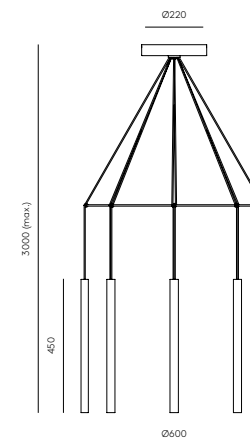

BIGCOSS 1,001€ (+IVA)

C1203/80

Designed by AC Studio, 2023

DESCRIPTION

MATERIALS

Metal / Acrylic / Crystal

FINISHES

Body:

Matt Black

Diffuser:

Mirror

SPECIFICATIONS

LED Strip 25W 2700K TRIAC

Dimmable + LED Spotlight

15W 2700K TRIAC dimmable

24V, 50/60Hz

IP20, Class I

ENERGY LABEL

A++

MATERIALES

Metal / Acrílico / Cristal

ACABADOS

Cuerpo:

Negro Mate

Diffusor:

Espejo

ESPECIFICACIONES

Tira LED 25W 2700K TRIAC

regulable + Proyector LED





15W 2700K TRIAC regulable

24 V, 50/60 Hz

IP20, Clase I

ETIQUETA ENERGÉTICA

A++

⊕ IP20 CE    

TECHNICAL

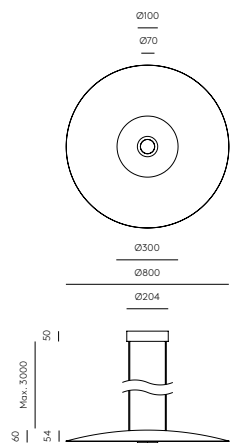

218

Beirut, Lebanon



ANET 347€ (+IVA)

Pendant lamp

C1206

Designed by Agus Gascón, 2018

DESCRIPTION

MATERIALS

Steel / Marble / Blown Glass

FINISHES

Metal:
Matt Black
Bronze
Aged Gold

Marble:
White
Brown
Green

Glass:
Opal

RECOMMENDED BULB
B005 /5W

SPECIFICATIONS

BULB G9 LED (INCLUDED)
5W - 3000K
220-240 V, 50/60 HZ
IP20, CLASS I

ENERGY LABEL
A ++

Ⓜ IP20 CE E X A ++

MATERIALES

Acero / Mármol / Vidrio Soplado

ACABADOS

Metal:
Negro Mate
Bronce
Oro Envejecido

Mármol:
Blanco
Marrón
Verde

Cristal:
Opal

BOMBILLA RECOMENDADA
B005/5W

ESPECIFICACIONES

Bombilla G9 Led (Incluida)
5W - 3000K
220-240 V, 50/60 Hz
IP20, Clase I

ETIQUETA ENERGÉTICA
A ++

TECHNICAL

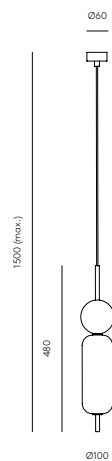

220



MARU 303€ (+IVA)

Pendant lamp

C1194

Designed by JF Sevilla, 2015

DESCRIPTION

MATERIALS

Steel

FINISHES

Metal:
Matt Black - Matt Brass
Matt Black - Matt Black

SPECIFICATIONS

INTEGRATED LED
3W - 3150K
12 V, 50/60 HZ
IP20, CLASS I

ENERGY LABEL
A ++

Ⓜ IP20 CE E X A ++

MATERIALES

Acero

ACABADOS

Metal:
Negro Mate - Oro Mate
Negro Mate - Negro Mate

ESPECIFICACIONES

LED integrado
3W - 3150K
12 V, 50/60 Hz
IP20, Clase I

ETIQUETA ENERGÉTICA
A ++

TECHNICAL

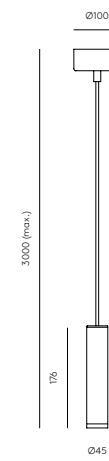

221



DAMO

Negro Mate: 531€ (+IVA)
Oro Mate: 611€ (+IVA)

Pendant lamp

C1191

Designed by AC Studio, 2015

DESCRIPTION

MATERIALS

Steel / Glass

FINISHES

Metal:
Matt Black
Matt Brass

Diffuser:
Opal

RECOMMENDED BULB





B211 (7, 9, 11W)

SPECIFICATIONS

2 x E27 Max. 60W
(Not included)
220-240 V, 50/60 Hz
IP20, Class I

ENERGY LABEL

A ++

⊕ IP20 CE    

MATERIALES

Acero / Vidrio

ACABADOS

Metal:
Negro Mate
Oro Mate

Diffuser:
Cristal Opal

BOMBILLA RECOMENDADA

B211 (7, 9, 11W)

ESPECIFICACIONES

2 x E27 Max. 60W
(No incluida)
220-240 V, 50/60 Hz
IP20, Clase I

ETIQUETA ENERGÉTICA

A ++

TECHNICAL

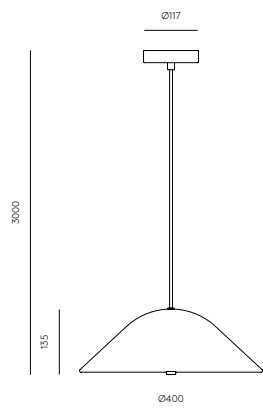

222



ELLA

588€ (+IVA)

Pendant lamp

C1158

Designed by AC Studio, 2020

DESCRIPTION

MATERIALS

Steel / Acrylic

FINISHES

Big Dome:
Matt Black - Exterior
Matt White - Interior





Diffuser:
Matt Black
Matt Brass
Shiny Gold
Chrome

SPECIFICATIONS

Integrated 9W LED
2700K TRIAC dimmable
24V, 50/60 Hz

ENERGY LABEL

A ++

⊕ IP20 CE    

MATERIALES

Metal / Acrílico

ACABADOS

Cúpula grande:
Negro Mate - Exterior
Blanca Mate - Interior

Diffuser:
Negro Mate
Oro mate
Oro brillo
Cromo

ESPECIFICACIONES

LED integrado 9W
2700K TRIAC regulable
24V, 50/60 Hz

ETIQUETA ENERGÉTICA

A ++

TECHNICAL

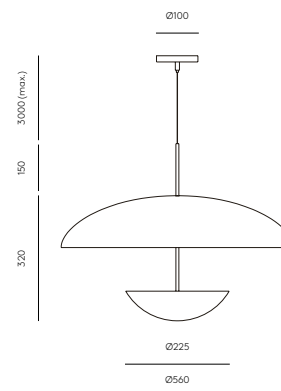

223

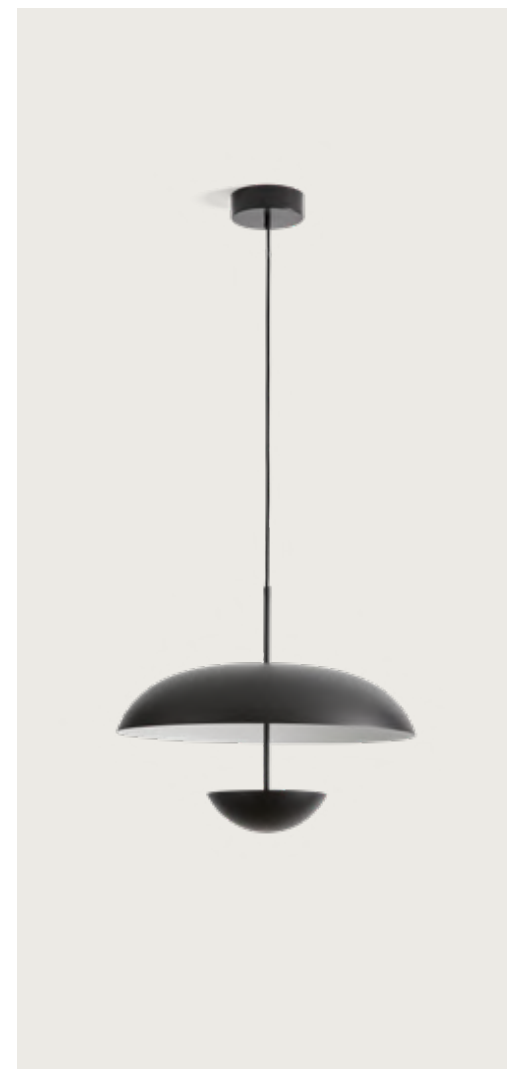

ENDO 1,215€ (+IVA)

*Preguntar por disponibilidad

Pendant lamp

C1156

Designed by Pepe Fornas, 2013



DESCRIPTION

MATERIALS

Steel / Glass

FINISHES

Metal:
Matt Black
Chrome

Glass:
Opal

RECOMMENDED BULB

B005/5W

SPECIFICATIONS

G9 LED Bulbs (Included)
6 x 5W - 2700K
220-240 V, 50/60 Hz
IP20, Class I

ENERGY LABEL

A++

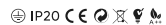

TECHNICAL

MATERIALES

Acero / Vidrio

ACABADOS

Metal:
Negro Mate
Cromo

Vidrio:
Opal

BOMBILLA RECOMENDADA

B005/5W

ESPECIFICACIONES

Bombillas G9 LED (Incluidas)
6 x 5W - 2700K
220-240 V, 50/60 Hz
IP20, Clase I

ETIQUETA ENERGÉTICA

A++

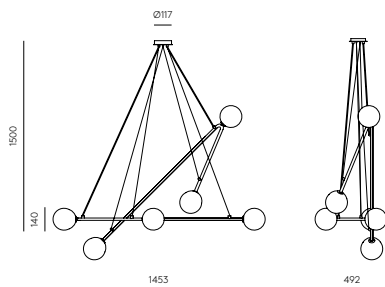

Geneva, Switzerland





CHAPEAU 382€ (+IVA)

Pendant lamp

C1157

Designed by Paloma Marín, 2022

DESCRIPTION

MATERIALS

Steel / Ceramics

FINISHES

Metal:
Matt brass
Matt black
Matt white

Ceramics:

Hand painted
See colour palette

Image colour:

Left: Green leaf
Right: Silhouette

SPECIFICATIONS (UE)

E27 max. 11W LED
(Not included)
230V, 50/60 Hz
IP20, Class I
Hand painted

ENERGY LABEL

A ++

IP20 CE ENEC RoHS REACH

MATERIALES

Acero / Cerámica

ACABADOS

Metal:
Oro mate
Negro mate
Blanco mate

Cerámica:

Pintado a mano
Consultar paleta de colores

Color en imagen:

Izda: Verde hoja
Dcha: Silhouette

ESPECIFICACIONES (UE)

E27 max. 11W LED
(No incluido)
230V, 50/60 Hz
IP20, Clase I
Pintado a mano

ETIQUETA ENERGÉTICA

A ++

TECHNICAL

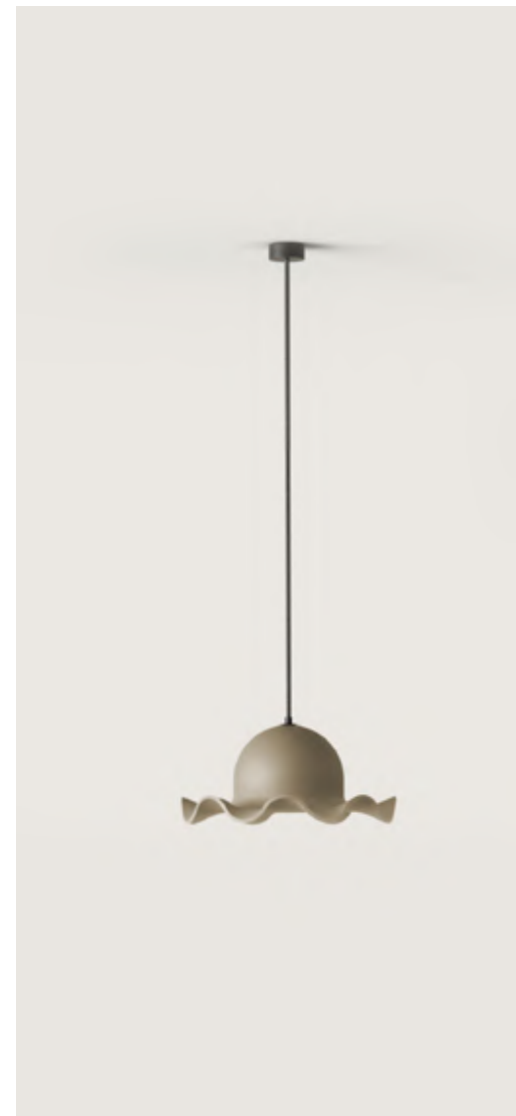
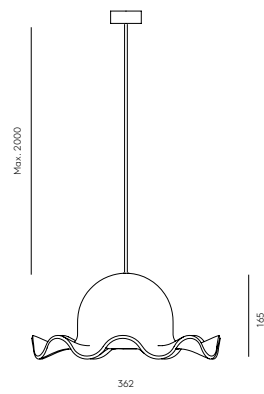

CORA 371€ (+IVA)

Pendant lamp

C1129

Designed by AC Studio, 2023

DESCRIPTION

MATERIALS

Steel / Ceramics

FINISHES

Metal:

Shiny gold
Chrome
White
Black

Ceramics:

Hand painted
See colour palette

Image colour:

Left: Taupe
Right: White

SPECIFICATIONS (UE)

Direct LED plate 7W 3000K
220-240V, 50/60Hz
IP20, Class I

ENERGY LABEL

A ++

IP20 CE ENEC

MATERIALES

Acero / Cerámica

ACABADOS

Metal:

Oro Brillo
Cromo
Blanco
Negro

Cerámica:

Pintada a mano
Consultar paleta de colores

Color ne imagen:

Izda: Topo
Dcha: Blanco

ESPECIFICACIONES (UE)

Placa LED directa 7W 3000K
220-240 V, 50/60 Hz
IP20, Clase I

ETIQUETA ENERGÉTICA

A ++

TECHNICAL

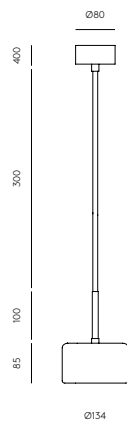

PTAN 443€ (+IVA)

Pendant lamp

C1154

Designed by Fornasevi, 2018

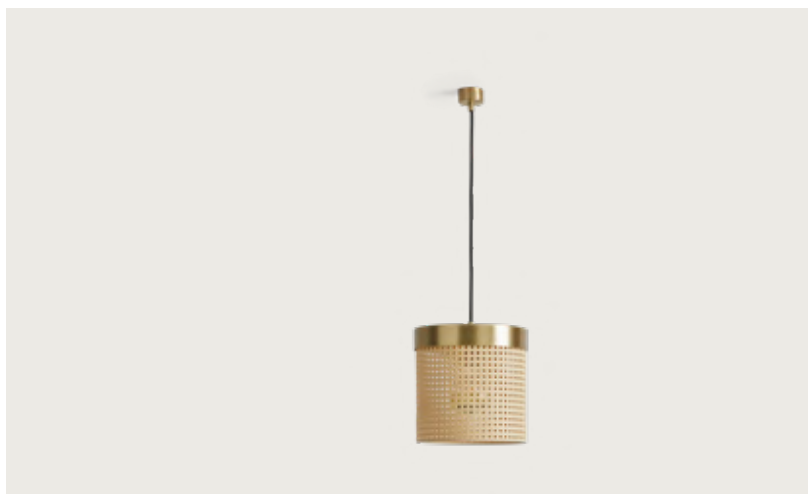

DESCRIPTION

MATERIALS

Steel / Rattan

FINISHES

Metal:
Matt Brass
Matt Black

Rattan:
Natural
Black

RECOMMENDED BULB

B033/COB (Opal)
B035/GOLD (Mirrored)

SPECIFICATIONS

E27 Max. 60W
(Not included)
220-240 V, 50/60 Hz
IP20, Class I

ENERGY LABEL

A ++

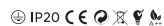

MATERIALES

Acero / Ratán

ACABADOS

Metal:
Oro Mate
Negro Mate

Ratán:
Natural
Negro

BOMBILLA RECOMENDADA

B033/COB (Opal)
B035/ORO (Espejada)

ESPECIFICACIONES

E27 Max. 60W
(No incluida)
220-240 V, 50/60 Hz
IP20, Clase I

ETIQUETA ENERGÉTICA

A ++

TECHNICAL

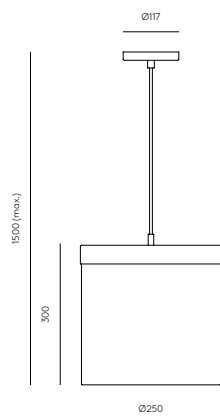

COPO 289€ (+IVA)

Pendant lamp

C1085

Designed by Pepe Fornas, 2021

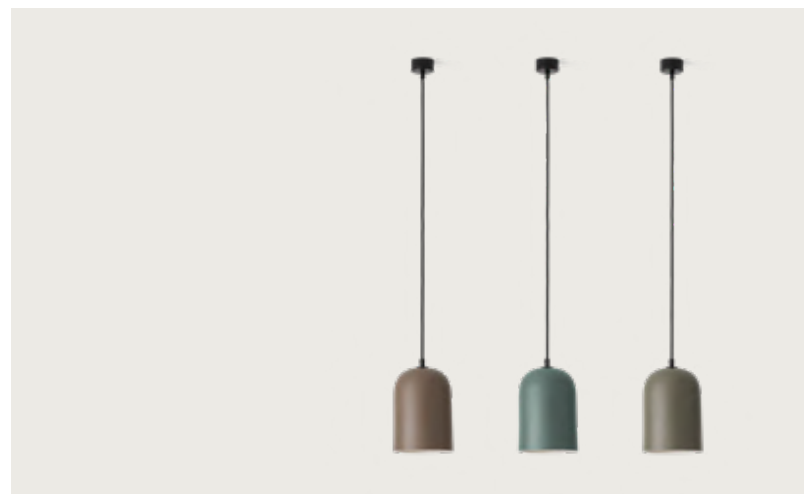

DESCRIPTION

MATERIALS

Steel / Ceramic

FINISHES

Metal:
Matt gold
Shiny gold
Matt black
Matt white

Ceramic:

Left to right colors:
Vintage brown
Dunkel green
Green Leaf
Color palette on page 432

SPECIFICATIONS

E27max. 11WLED (not included)
230V, 50/60 Hz, IP20, Class I

ENERGY LABEL

A ++

HAND PAINTED



MATERIALES

Acero / Cerámica

ACABADOS

Metal:
Oro mate
Oro Brillo
Negro mate
Blanco mate

Cerámica:

Colores de izq. a dcha:
Marrón vintage
Verde dunkel
Verde hoja
Paleta de colores en la pág. 432

ESPECIFICACIONES

E27 max. 11W LED (no incluida)
230V, 50/60 Hz IP20, Clase I

ETIQUETA ENERGÉTICA

A ++

PINTADO A MANO

TECHNICAL

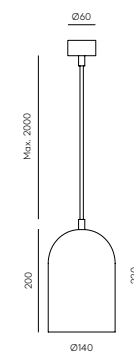

C1085



BELL 377€ (+IVA)

Pendant lamp

C1084
Designed by Pepe Fornas, 2021

DESCRIPTION

MATERIALS

Steel / Ceramic / Marble

FINISHES

Metal:
Matt gold
Shiny gold
Matt black
Matt white

Marble:
Natural
White
Black
Green
Brown

Ceramic:
Hand painted
Check colour palette

Image colours:
Left: Terracotta + white marble
/ Nude
Right: Ash grey + green marble

SPECIFICATIONS

E27max. 11WLED (not included)
230V, 50/60 Hz, IP20, Class I

ENERGY LABEL

A ++

IP20 CE RoHS WEEE

MATERIALES

Acero / Mármol / Cerámica

ACABADOS

Metal:
Oro mate
Oro Brillo
Negro mate
Blanco mate

Mármol:
Natural
Blanco
Negro
Verde

Cerámica:
Marrón
Pintada a mano
Consulta paleta de colores

Colores en imagen:
Izda: Terracotta + mármol
blanco / Nude
Dcha: Gris ceniza + mármol
verde

ESPECIFICACIONES

E27 max. 11W LED (no incluida)
230V, 50/60 Hz IP20, Clase I

ETIQUETA ENERGÉTICA

A ++

TECHNICAL

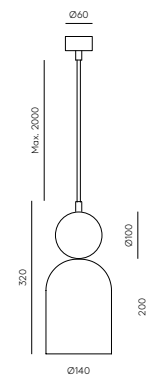

C1084

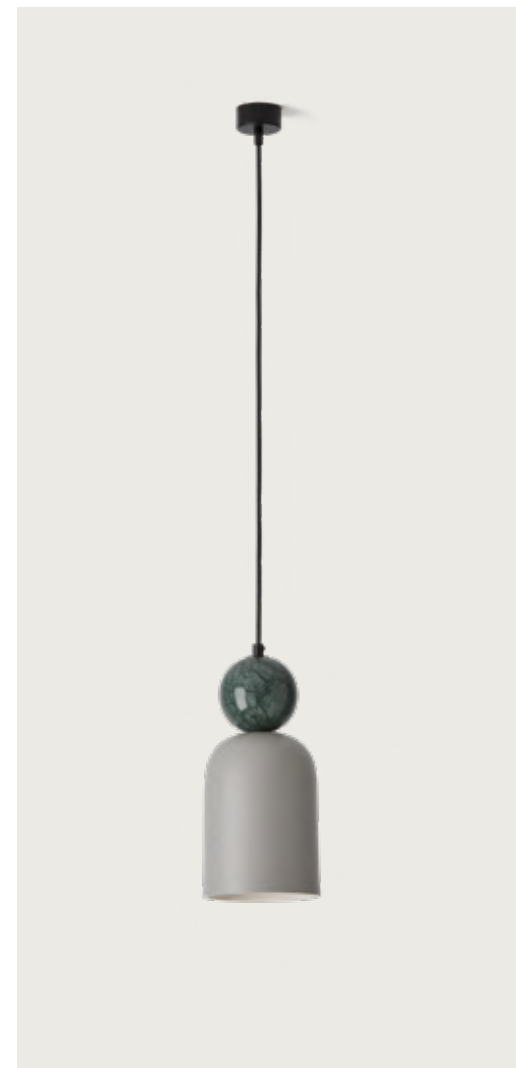

ALPHA 289€ (+IVA)

Pendant lamp

C1083

Designed by AC Studio, 2019

DESCRIPTION

MATERIALS

Steel

FINISHES

Metal:
Black
Gold
Chrome
White

Shade:

Check color Palette
Image color: Banana Green

POSSIBLE MODIFICATIONS

Special finish - Extracost

RECOMMENDED BULB

B211 (7, 9, 11W)

SPECIFICATIONS

E27 Max. 60W (Not included)
220-240 V, 50/60 Hz, IP20,
Class I

ENERGY LABEL

A ++

Ⓜ IP20 CE E X A++

MATERIALES

Acero

ACABADOS

Metal:
Negro
Oro
Cromo
Blanco

Tulipa:

Consultar paleta colores
Color en imagen: Banana Green

MODIFICACIONES POSIBLES

Acabado especial - Sobrecoste

BOMBILLA RECOMENDADA

B211 (7, 9, 11W)

ESPECIFICACIONES

E27 Max. 60W (No incluida)
220-240 V, 50/60 Hz, IP20,
Clase I

ETIQUETA ENERGÉTICA

A ++

TECHNICAL

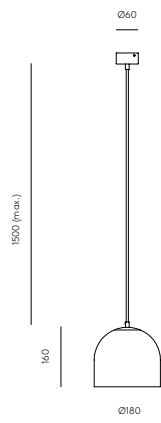

234

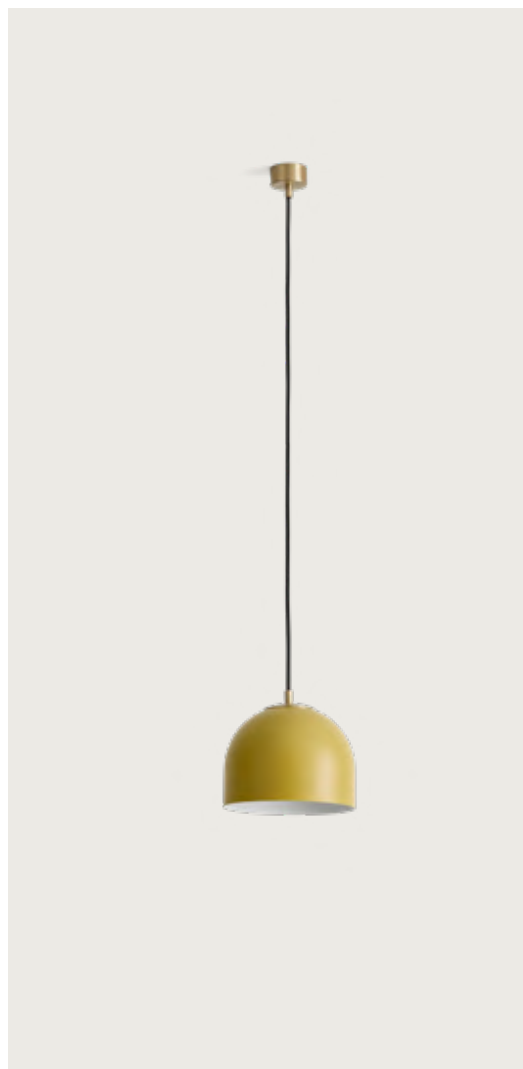

BETA 396€ (+IVA)

Pendant lamp

C1082

Designed by AC Studio, 2019

DESCRIPTION

MATERIALS

Steel

FINISHES

Metal:
Black
Gold
Chrome
White

Shade:

Check color Palette
Image color: Mineral red

POSSIBLE MODIFICATIONS

Special finish - Extracost

SPECIFICATIONS

E27 Max. 60W (Not included)
220-240 V, 50/60 Hz, IP20,
Class I

ENERGY LABEL

A ++

Ⓜ IP20 CE E X A++

MATERIALES

Acero

ACABADOS

Metal:
Negro
Oro
Cromo
Blanco

Tulipa:

Consultar paleta Colores
Color en imagen: Rojo mineral

MODIFICACIONES POSIBLES

Acabado especial - Sobrecoste

ESPECIFICACIONES

E27 Max. 60W (No incluida)
220-240 V, 50/60 Hz, IP20,
Clase I

ETIQUETA ENERGÉTICA

A ++

TECHNICAL

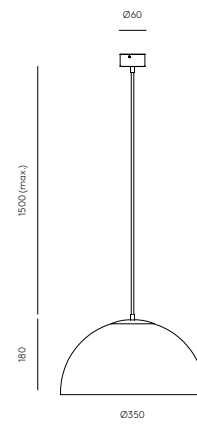

235



GAMMA 658€ (+IVA)

Pendant lamp

C1081

Designed by AC Studio, 2019

DESCRIPTION

MATERIALS

Steel

FINISHES

Diffuser:

Black
Chrome
Gold

Shade:

Image colours:
Up Make up,
Down Green Leaf.
Check color palette on page 425

POSSIBLE MODIFICATIONS

Special finish - Extracost
E27 Lamp holder

RECOMMENDED BULB

B033/COB (IF USED WITH E27)

SPECIFICATIONS

Led Diffuser 9W - 3000K
12 V, 50/60 Hz, IP20, Class I

ENERGY LABEL

A ++

IP20 CE RoHS WEEE

MATERIALES

Acero

ACABADOS

Diffusor:

Negro
Cromo
Oro

Tulipa:

Colores en imagen: Arriba
Maquillaje, abajo verde hoja.
Consulta paleta de colores en
pág. 425

MODIFICACIONES POSIBLES

Acabado especial - Sobrecoste
Portalámparas E27

BOMBILLA RECOMENDADA

B033/COB (SI SE USA CON E27)

ESPECIFICACIONES

Diffusor Led 9W - 3000K
12 V, 50/60 Hz, IP20, Clase I

ETIQUETA ENERGÉTICA

A ++

TECHNICAL

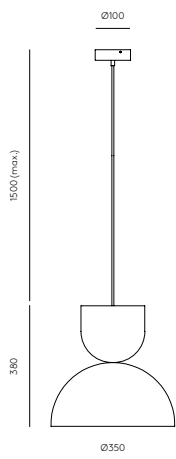

ELLEN

Negro Mate / Blanco: 944€ (+IVA)
Oro Brillo / Cromo: 1,252€ (+IVA)

Pendant lamp

C1048
Designed by AC Studio, 2014

DESCRIPTION

MATERIALS

Steel

FINISHES

Metal:
Black
White
Shiny Gold
Chrome

RECOMMENDED BULB

B019

SPECIFICATIONS

E27 Max. 60W (Not included)
220-240 V, 50/60 Hz
IP20, Class I

ENERGY LABEL

A ++

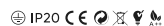

MATERIALES

Acero

ACABADOS

Metal:
Negro
Blanco
Oro brillo
Cromo

BOMBILLA RECOMENDADA

B019

ESPECIFICACIONES

E27 Max. 60W (No incluida)
220-240 V, 50/60 Hz
IP20, Clase I

ETIQUETA ENERGÉTICA

A ++

TECHNICAL

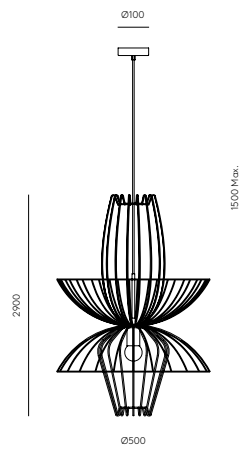

CRAWFORD

Negro Mate / Blanco: 732€ (+IVA)
Oro Brillo / Cromo: 938€ (+IVA)

Pendant lamp

C1047
Designed by Pepe Fornas, 2014

DESCRIPTION

MATERIALS

Steel

FINISHES

Metal:
Black
White
Shiny Gold
Chrome

RECOMMENDED BULB

B033

SPECIFICATIONS

E27 Max. 60W (Not included)
220-240 V, 50/60 Hz
IP20, Class I

ENERGY LABEL

A ++



MATERIALES

Acero

ACABADOS

Metal:
Negro
Blanco
Oro brillo
Cromo

BOMBILLA RECOMENDADA

B033

ESPECIFICACIONES

E27 Max. 60W (No incluida)
220-240 V, 50/60 Hz
IP20, Clase I

ETIQUETA ENERGÉTICA

A ++

TECHNICAL

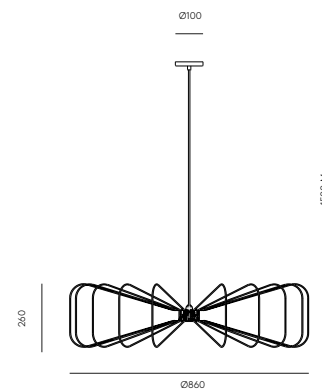

DISC 15cm: 140€ (+IVA)
 25 cm: 210€ (+IVA)
 35 cm: 256€ (+IVA)

Pendant lamp

C1038
 Designed by JF Sevilla, 2014



DESCRIPTION

MATERIALS
 Steel

FINISHES

Metal:
 Black
 White
 Shiny Gold
 Chrome
 Matt Brass

AVAILABLE SIZES
 Disc sizes Ø15, Ø25, Ø35 cm

RECOMMENDED BULB
 B035/GOLD / B038

SPECIFICATIONS
 E27 Max. 60W (Not included)
 220-240 V, 50/60 Hz
 IP20, Class I

ENERGY LABEL
 A ++



MATERIALES
 Acero

ACABADOS

Metal:
 Negro
 Blanco
 Oro brillo
 Cromo
 Oro mate

MEDIDAS DISPONIBLES
 Medidas disco Ø15, Ø25, Ø35 cm

BOMBILLA RECOMENDADA
 B035/ORO / B038

ESPECIFICACIONES
 E27 Max. 60W (No incluida)
 220-240 V, 50/60 Hz
 IP20, Class I

ETIQUETA ENERGÉTICA
 A ++

TECHNICAL

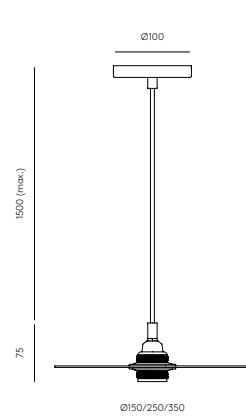

OPEN 333€ (+IVA)

Pendant lamp

C1024
 Designed by AC Studio, 2009

DESCRIPTION

MATERIALS
 Fabric Cotton / Steel

FINISHES

Fabric:
 White
 Grey
 Black

Diffuser:
 White

Fabric:
 Chrome

RECOMMENDED BULB
 B211 (7, 9, 11W)

SPECIFICATIONS
 3 x E27 Max. 60W (Not included)
 220-240 V, 50/60 Hz
 IP20, Class I

ENERGY LABEL
 A ++

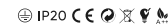

MATERIALES
 Loneta de Algodón / Acero

ACABADOS

Tela:
 Blanco
 Gris
 Negro

Difusor:
 Blanco

Metal:
 Cromo

BOMBILLA RECOMENDADA
 B211 (7, 9, 11W)

ESPECIFICACIONES
 3 x E27 Max. 60W (No incluida)
 220-240 V, 50/60 Hz
 IP20, Class I

ETIQUETA ENERGÉTICA
 A ++

TECHNICAL

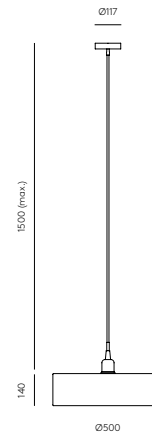

C1012 147€ (+IVA)

Pendant lamp

C1012

Designed by Agus Gascón, 2020

DESCRIPTION

MATERIALS

Steel / Glass

FINISHES

Metal:
Matt Black

Glass:
Clear
Black Smoked

SPECIFICATIONS

E27 3W 3000K (Included)
220-240 V, 50/60 Hz

ENERGY LABEL

A ++

LAMP HOLDER AND BULB
SOLD INDIVIDUALLY

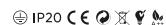

MATERIALES

Acero / Vidrio

ACABADOS

Metal:
Negro Mate

Cristal:
Transparente
Fumé Negro

ESPECIFICACIONES

E27 3W 3000K (Incluida)
220-240 V, 50/60 Hz

ETIQUETA ENERGÉTICA

A ++

PORTALÁMPARAS Y BOMBILLA
SE VENDEN POR SEPARADO



TECHNICAL

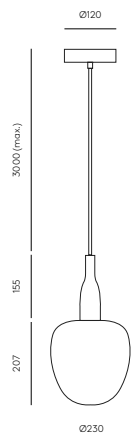

242

ANYA 40cm: 399€ (+IVA) 50cm: 424€ (+IVA)

Pendant lamp

C1010 + 1143 / 1144

Designed by Fornasevi, 2020



DESCRIPTION

MATERIALS

Natural Bamboo / Steel

FINISHES

C1010:
Matt Brass
Matt Black

Shade 1143/1144:
Bamboo-Black
Bronze

RECOMMENDED BULB

B052

SPECIFICATIONS

E27 Max. 60W (Not included)
220-240 V, 50/60 Hz
IP20, Class I

ENERGY LABEL

A ++



MATERIALES

Bambú Natural / Acero

ACABADOS

C1010:
Oro Mate
Negro Mate

Pantalla 1143/1144:
Bambú- Negro
Bronze

BOMBILLA RECOMENDADA

B052

ESPECIFICACIONES

E27 Max. 60W (No incluida)
220-240 V, 50/60 Hz
IP20, Clase I

ETIQUETA ENERGÉTICA

A ++

TECHNICAL

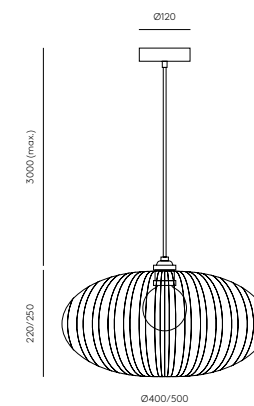

243

DOUL 256€ (+IVA)

Pendant lamp

T1310

Designed by Agus Gascón, 2023



DESCRIPTION

MATERIALS

Steel / Glass

FINISHES

Body:

Matt black / Matt Brass

Glass:

Striped glass - Transparent

SPECIFICATIONS (UE)

G4 LEDs 3W 2700K

Adjustable (Incluida)

220-240V, 50/60Hz

IP20, Class I

ENERGY LABEL

A ++

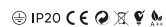

TECHNICAL

MATERIALES

Metal / Vidrio

ACABADOS

Cuerpo:

Negro mate / Oro envejecido

Cristal:

Cristal rayado - Transparente

ESPECIFICACIONES (UE)

G4 LED 3W 2700K

Regulable (Incluida)

220-240 V, 50/60 Hz

IP20, Clase I

ETIQUETA ENERGÉTICA

A ++

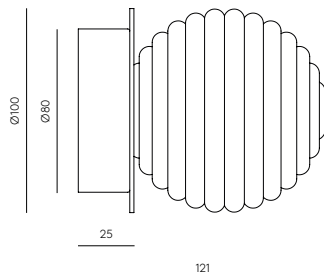

YCRO 189€ (+IVA)

Pendant lamp

T1297

Designed by JF Sevilla, 2022



DESCRIPTION

MATERIALS

Steel

FINISHES

Matt black & Matt gold

Matt Black

SPECIFICATIONS

Integrated LED chip

8W - 3000K

Dimmable by DALI/PUSH

220-240V - 24V - 50/60Hz

IP20 - Class I

ENERGY LABEL

A ++



TECHNICAL

MATERIALES

Acero

ACABADOS

Negro mate y oro mate

Negro mate

ESPECIFICACIONES

Chip LED integrado

8W - 3000K

Regulable por DALI/PUSH

220-240V - 24V - 50/60 Hz

IP20 - Clase I

ETIQUETA ENERGÉTICA

A ++

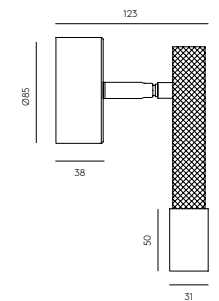

YCRO 788€ (+IVA)

Pendant lamp

T1297/4

Designed by JF Sevilla, 2022



DESCRIPTION

MATERIALS

Steel

FINISHES

Matt black & Matt gold
Matt Black

SPECIFICATIONS

4x Integrated LED chip
8W - 3000K
Dimmable by DALI/PUSH
220-240V - 24V - 50/60Hz
IP20 - Class I

ENERGY LABEL

A ++

⊕ IP20 CE RoHS RECYCLED ♻️

MATERIALES

Acero

ACABADOS

Negro mate y oro mate
Negro mate

ESPECIFICACIONES

4x Chip LED integrado
8W - 3000K
Regulable por DALI/PUSH
220-240V - 24V - 50/60 Hz
IP20 - Clase I

ETIQUETA ENERGÉTICA

A ++

TECHNICAL

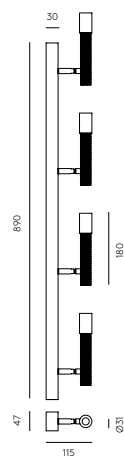

FOCUS 219€ (+IVA)

Pendant lamp

T1279

Designed by Pepe Fornas, 2021

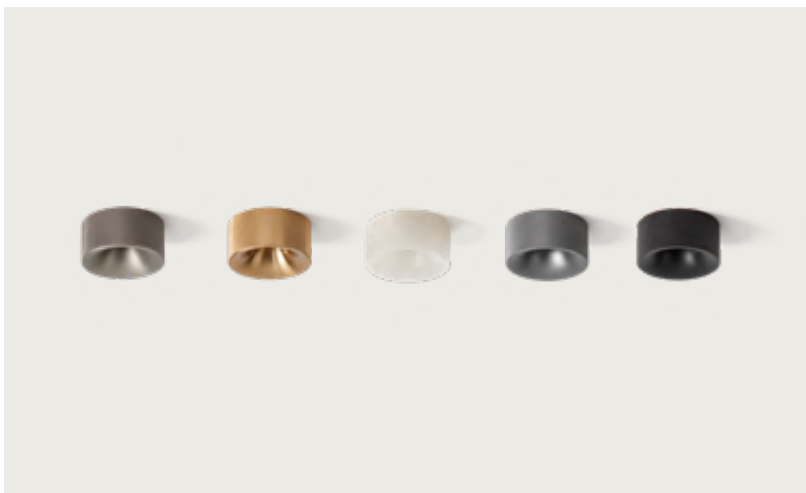

DESCRIPTION

MATERIALS

Steel / Alabaster

FINISHES

Black
Aged gold
Anthracite
Nickel
Alabaster

SPECIFICATIONS

GU10 LED (included)
5W - 2700K
230V - 50/60Hz
IP20 - Class I

ENERGY LABEL

A ++

RECESSED LAMP



MATERIALES

Acero / Alabastro

ACABADOS

Negro
Oro mate
Antracita
Niquel
Alabastro

ESPECIFICACIONES

GU10 LED (incluido)
5W - 2700K
230V - 50/60 Hz
IP20 - Clase I

ETIQUETA ENERGÉTICA

A ++

LÁMPARA EMPOTRABLE

TECHNICAL

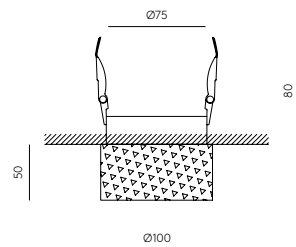

NOON 172€ (+IVA)

Pendant lamp

T1278/1

Designed by AC Studio, 2022

DESCRIPTION

MATERIALS

Steel

FINISHES

Blued
Matt black

SPECIFICATIONS

GU10 5W - 3000K (Included)
Dimmable by Triac
220-240V, 50/60Hz
IP20, Class I

ENERGY LABEL

A ++

MATERIALES

Acero

ACABADOS

Pavonado
Negro mate

ESPECIFICACIONES

GU10 5W - 3000K (Incluida)
Regulable por Triac
220-240 V, 50/60 Hz
IP20, Clase I

ETIQUETA ENERGÉTICA

A ++



TECHNICAL

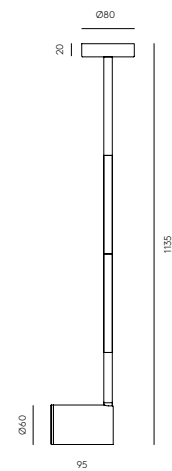

NOON 273€ (+IVA)

Pendant lamp

T1278/3

Designed by AC Studio, 2022



DESCRIPTION

MATERIALS
Steel

FINISHES
Blued
Matt black

SPECIFICATIONS
3 x GU10 5W - 3000K (Included)
Dimmable by Triac
220-240V, 50/60Hz
IP20, Class I

ENERGY LABEL
A ++

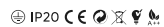

TECHNICAL

MATERIALES
Acero

ACABADOS
Pavonado
Negro mate

ESPECIFICACIONES
3 x GU10 5W - 3000K (Incluida)
Regulable por Triac
220-240 V, 50/60 Hz
IP20, Clase I

ETIQUETA ENERGÉTICA
A ++

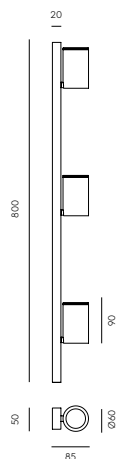

NOON 137€ (+IVA)

Pendant lamp

T1278

Designed by AC Studio, 2022

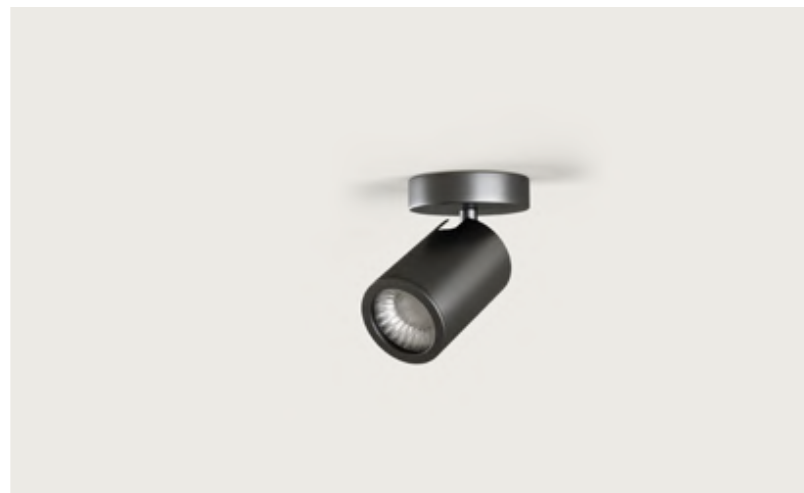

DESCRIPTION

MATERIALS
Steel

FINISHES
Blued
Matt black

SPECIFICATIONS
GU10 5W - 3000K (Included)
Dimmable by Triac
220-240V, 50/60Hz
IP20, Class I

ENERGY LABEL
A ++

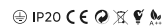

TECHNICAL

MATERIALES
Acero

ACABADOS
Pavonado
Negro mate

ESPECIFICACIONES
GU10 5W - 3000K (Incluida)
Regulable por Triac
220-240 V, 50/60 Hz
IP20, Clase I

ETIQUETA ENERGÉTICA
A ++

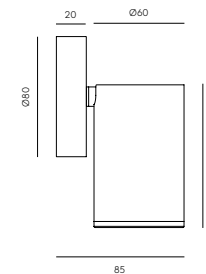



NOON



LATTO 228€ (+IVA)

Pendant lamp

T1268

Designed by AC Studio, 2023



DESCRIPTION

MATERIALS

Alluminium

FINISHES

Aged gold
Matt black
Anthracite

SPECIFICATIONS

GU10 LED 5W 2700K
Dimmable (Incluida)
220-240 V, 50/60 Hz
IP20, Class I

ENERGY LABEL

A++

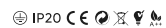

TECHNICAL

MATERIALES

Aluminio

ACABADOS

Oro envejecido
Negro mate
Antracita

ESPECIFICACIONES

GU10 LED 5W 2700K
Regulable (Incluida)
220-240 V, 50/60 Hz
IP20, Clase I

ETIQUETA ENERGÉTICA

A++

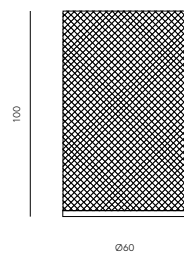

TAMB 30-50

30 cm: 207€ (+IVA)

50 cm: 249€ (+IVA)

Pendant lamp

T1019/30 - T1019/50

Designed by Pepe Fornas, 2021

DESCRIPTION

MATERIALS

Fabric Cotton

MATERIALES

Loneta de algodón

FINISHES

Shade:

White
Grey
Black

Diffuser:

White

ACABADOS

Pantalla:

Blanco
Gris
Negro

Difusor:

Blanco

SPECIFICATIONS

2x E27 Max. 60W
(Not included)
220-240V - 50/60Hz
IP20 - Class I

ESPECIFICACIONES

2x E27 Max. 60W
(No incluida)
220-240V - 50/60Hz
IP20 - Clase I

ENERGY LABEL

A ++

ETIQUETA ENERGÉTICA

A ++

RECOMMENDED BULB

B211 (7, 9, 11W)

BOMBILLA RECOMENDADA

B211 (7, 9, 11W)

⊕ IP20 CE ENEC

TECHNICAL

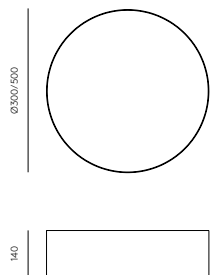

256



TAMB SQUARE

224€ (+IVA)

Pendant lamp

T1016

Designed by JF Sevilla, 2022

DESCRIPTION

MATERIALS

Fabric Cotton

MATERIALES

Loneta de algodón

FINISHES

Shade:

White
Grey
Black

Diffuser:

White

ACABADOS

Pantalla:

Blanco
Gris
Negro

Difusor:

Blanco

SPECIFICATIONS

2x E27 Max. 60W
(Not included)
220-240V - 50/60Hz
IP20 - Class I

ESPECIFICACIONES

2x E27 Max. 60W
(No incluida)
220-240V - 50/60Hz
IP20 - Clase I

ENERGY LABEL

A ++

ETIQUETA ENERGÉTICA

A ++

RECOMMENDED BULB

B211 (7, 9, 11W)

BOMBILLA RECOMENDADA

B211 (7, 9, 11W)

⊕ IP20 CE ENEC

TECHNICAL

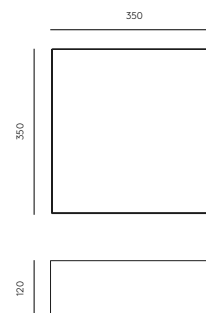

257



CREATE YOUR OWN
PENDANT LAMP



CREA TU PROPIA
LÁMPRA COLGANTE

01

Which pendant is ideal for your lamp?

Search through our extensive catalog of individual pendants and choose the ideal one for your idea and space.

Qué colgante es ideal para su lámpara?

Busque entre nuestro amplio catálogo de colgantes individuales y elija el ideal para tu idea y espacio.

02

Shape and measurements of the canopy

Check the space where the lamp will be installed and check which size and shape best suits it.

Forma y medidas del florón

Revise el espacio donde se instalará la lámpara y compruebe qué tamaño y forma se adapta mejor al mismo.



Round

300 x 300 x 45 mm
500 x 500 x 45 mm
700 x 700 x 45 mm

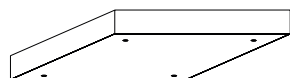

Square

400 x 400 x 45 mm
600 x 400 x 45 mm

Rectangle

700 x 250 x 45 mm
700 x 45 x 45 mm

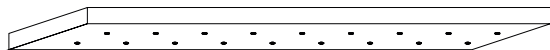

** Para otras medidas y formas, consulte a nuestro departamento técnico y comercial.*

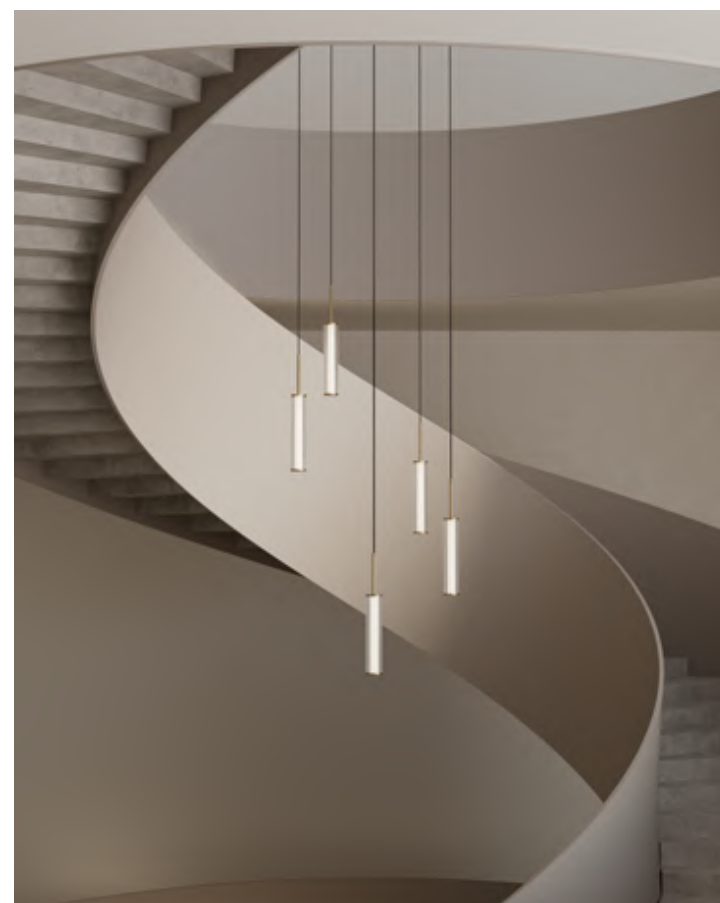

03

Finishes and canopy outsides

Our basic finishes are: Matt black and matt white.

You must inform us of the number of outlets and their distribution, as well as the length of each pendant.

Acabados y salidas del florón

Nuestros acabados básicos son: Negro mate y blanco mate.

Debe informarnos del número de salidas y su distribución, así como de la longitud de cada colgante.



Floor

Lamps

264	ELMA • P1312
266	ELLI • P1311
268	BION • P1306
270	FITO • P1286
271	FOCUS • P1279
272	NOOI • P1276
274	LYB • P1274
276	COLN • P1267
277	HINOO • P1266
280	ABBACUS • P1258
281	ARCTIC • P1256
282	MAHO • P1254
284	COT • P1251
285	FICUS • P1243
286	OHLALA • P1242
287	ARIO • P1234
288	LUCA • P1237
290	NERA • P1229
291	ATOM • P1214
292	COHEN GOLD • P1196
293	MARU • P1194
294	BOA • P1193
295	TRIPOD • P1184
296	DODO • P1169
297	RIU • P1140
298	HEDRA • P1159
300	ENDO • P1156
302	ONA • P1029
303	TEX • P1026

ELMA 1,029€ (+IVA)

Floor lamp

P1312

Designed by Jose Fornas, 2023

DESCRIPTION

MATERIALS

Metal / Glass / Acrylic

FINISHES

Metal: Matte Black
/ Antique Gold

Glass:
Striped glass - Transparente

Acrylic: Opal

SPECIFICATIONS

LED strip 20W 2700K TRIAC
dimmable

24V, 50/60Hz

IP20, Class I

ENERGY LABEL

A ++

⊕ IP20 CE   

MATERIALES

Metal / Vidrio / Acrílico

ACABADOS

Metal: Negro mate
/ Oro envejecido

Cristal:

Cristal estriado - Transparente

Acrílico: Opal

ESPECIFICACIONES

Tira LED 20W 2700K TRIAC
regulable

24V, 50/60 Hz

IP20, Clase I

ETIQUETA ENERGÉTICA

A ++

TECHNICAL

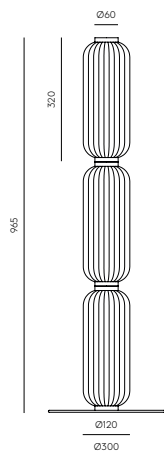

Milan, Italy

Melbourne, Australia



ELLI 1,365€ (+IVA)

Floor lamp

P1311

Designed by JF Sevilla, 2023



DESCRIPTION

MATERIALS

Metal / Acrylic / Marble

FINISHES

Metal: Matte Black

/ Antique Gold

Marble: Black

Acrylic: Opal

SPECIFICATIONS

LED strip 30W DALI/PUSH CCT

dimmable (adjust power and

temperature)

24V, 50/60Hz

IP20, Class II

ENERGY LABEL

A ++

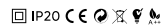

TECHNICAL

MATERIALES

Metal / Acrílico / Mármol

ACABADOS

Metal: Negro mate

/ Oro envejecido

Mármol: Negro

Acrílico: Opal

ESPECIFICACIONES

Tira LED 30W DALI/PUSH CCT

regulable (ajusta potencia y

temperatura)

24V, 50/60 Hz

IP20, Clase II

ETIQUETA ENERGÉTICA

A ++

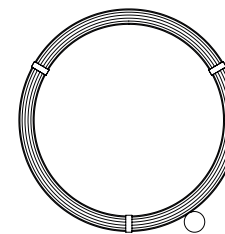

321

Ø1075



Ø100

250

BION 637€ (+IVA)

Floor lamp

P1306

Designed by Pepe Fornas, 2022

DESCRIPTION

MATERIALS

Steel / Marble

FINISHES

Body:

Matt black

Aged gold

Shade:

Matt black

Matt white

Base:

Mat black marble

SPECIFICATIONS (UE)

G9 LED 5W 2700K

Dimmable (Included)

Possibility to add

dimmer on cable

220-240 V, 50/60 Hz

IP20, Class II

ENERGY LABEL

A ++

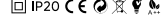

MATERIALES

Acero / Mármol

ACABADOS

Cuerpo:

Negro mate

Oro envejecido

Tulipa:

Negro mate

Blanco mate

Base:

Mármol negro mate

ESPECIFICACIONES (UE)

G9 LED 5W 2700K

Regulable (Incluida)

Possibilidad de añadir

regulación en cable

220-240 V, 50/60 Hz

IP20, Clase II

ETIQUETA ENERGÉTICA

A ++

TECHNICAL

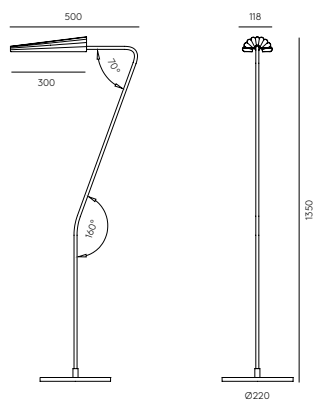

FITO 713€ (+IVA)

Floor lamp

P1286

Designed by Pepe Fornas, 2020

DESCRIPTION

MATERIALS

Steel / Marble

FINISHES

Metal:
Matt black

Base:
Black Marble

Rack:
Matt Brass

RECOMMENDED BULB

T8/14W

SPECIFICATIONS (UE)

T8 Led 14W (Incluido)

3000K

220-240 V, 50/60 Hz

IP20, Class II

ENERGY LABEL

A ++

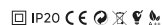

MATERIALES

Acero / Mármol

ACABADOS

Metal:
Negro Mate

Base:
Mármol Negro

Rejilla:
Oro Mate

BOMBILLA RECOMENDADA

T8/14W

ESPECIFICACIONES (UE)

T8 Led 14W (Incluido)

3000K

220-240 V, 50/60 Hz

IP20, Clase II

ETIQUETA ENERGÉTICA

A ++

TECHNICAL

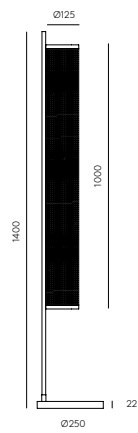

270



FOCUS 515€ (+IVA) *Cabeza de alabastro 63€ (+IVA)

Floor lamp

P1279

Designed by Pepe Fornas, 2019

DESCRIPTION

MATERIALS

Steel / Aluminium

FINISHES

Body:
Matt black

Head:
Aged Gold
Anthracite

POSSIBLE MODIFICATIONS

Alabaster head extra cost

RECOMMENDED BULB

B161

SPECIFICATIONS (UE)

GU10 Led Bulb (Incluido)

5W - 3000K

220-240 V, 50/60 Hz

IP20, Class II

ENERGY LABEL

A ++



MATERIALES

Acero / Mármol

ACABADOS

Cuerpo:
Negro Mate

Cabeza:
Oro Viejo
Antracita

MODIFICACIONES POSIBLES

Cabezal de alabastro coste extra

BOMBILLA RECOMENDADA

B161

ESPECIFICACIONES (UE)

Bombilla GU10 Led (Incluida)

5W - 3000K

220-240 V, 50/60 Hz

IP20, Clase II

ETIQUETA ENERGÉTICA

A ++

TECHNICAL

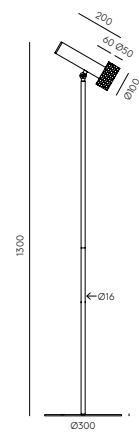

271

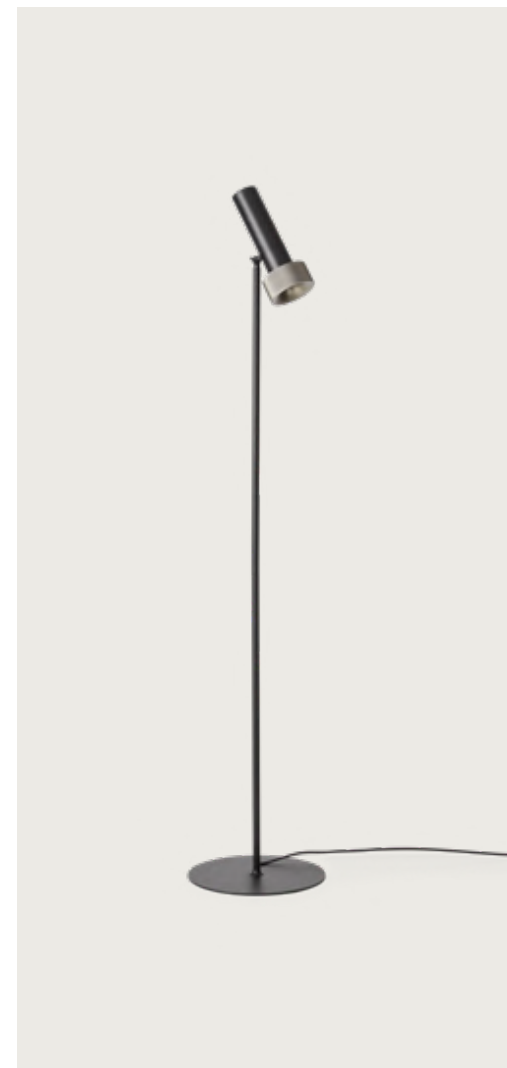

NOOI 630€ (+IVA)

Floor lamp

P1276

Designed by Pepe Fornas, 2022

DESCRIPTION

MATERIALS

Linen / Steel / Acrylic

FINISHES

Metal:
Matt Black

Shade:
Cream Linen textile

Acrylic:
Opal

SPECIFICATIONS (UE)

T8 14W - 3000K
Dimmer on cable
24V, 50/60Hz
IP20, Class II

ENERGY LABEL

A ++

IP20 CE RoHS RECYCLED

MATERIALES

Lino / Metal / Acrílico

ACABADOS

Metal:
Negro mate

Tulipa:
Textil Lino Crema

Acrílico:
Opal

ESPECIFICACIONES (UE)

T8 14W - 3000K
Regulador en cable
24 V, 50/60 Hz
IP20, Clase II

ETIQUETA ENERGÉTICA

A ++

TECHNICAL

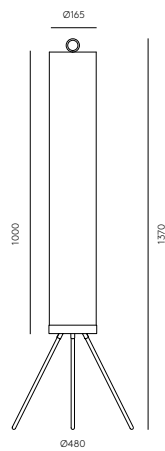

Toronto, Canada

Cape Town, South Africa



LYB 669€ (+IVA)

Floor lamp

P1274

Designed by Pepe Fornas, 2019

DESCRIPTION

MATERIALS

Steel

FINISHES

Metal:
Matt black

TOUCH ME DIMMABLE

SPECIFICATIONS (UE)

Chip Led dimmable integrated
5W, 3000K
12 V, 50/60 Hz
IP20, Class II

ENERGY LABEL

A ++

IP20 CE   

MATERIALES

Acero

ACABADOS

Metal:
Negro Mate

TOUCH ME REGULABLE

ESPECIFICACIONES (UE)

Chip Led regulable incluido 5W,
3000K
12 V, 50/60 Hz
IP20, Clase II

ETIQUETA ENERGÉTICA

A ++

TECHNICAL

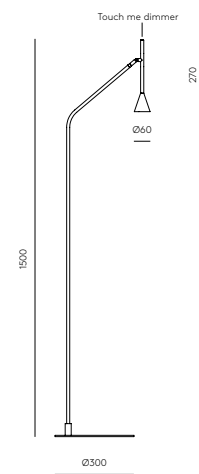

275



COLN 1,026€ (+IVA)

Floor lamp

P1267

Designed by AC Studio, 2019

DESCRIPTION

MATERIALS
Steel / Marble

FINISHES

Metal:
Matt Black
Marble:
Black

SPECIFICATIONS (UE)
Strip LED 21W 2700K
dimmer foot push on cable
24 V, 50/60 Hz, IP20, Class II

ENERGY LABEL
A ++

MATERIALES
Acero / Mármol

ACABADOS

Metal:
Negro mate
Mármol:
Negro

ESPECIFICACIONES (UE)
Tira LED 21W 2700K
Regulador en cable
24 V, 50/60 Hz, IP20, Clase II

ETIQUETA ENERGÉTICA
A ++

IP20 CE E U L

TECHNICAL

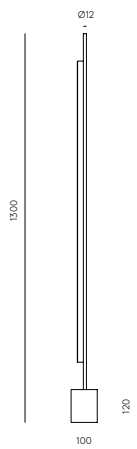

276

HINOO 1,015€ (+IVA)

Floor lamp

P1266

Designed by JF Sevilla, 2021

DESCRIPTION

MATERIALS
Steel / Marble / Acrylic

FINISHES

Body:
Black
Black and brass details
Marble:
White
Black

DIMMER ON CABLE
Integrated Dimmable LED
13W 3000K, 9-21V, 50/60 Hz,
IP20, Class II
Dimmer foot switch on cable

ENERGY LABEL
A ++

MATERIALES
ACERO / MÁRMOL / ACRÍLICO

ACABADOS

Cuerpo:
Negro mate
Detalles Negro Mate y Oro mate
Mármol:
Negro
Blanco

REGULADOR DE PIE EN CABLE
LED integrado Regulable
13W 3000K, 9-21V, 50/60 Hz,
IP20, Clase II
Interruptor y regulador en cable

ETIQUETA ENERGÉTICA
A ++

IP20 CE E U L

DESCRIPTION

MATERIALS
Steel / Marble / Acrylic

FINISHES

Body:
Black
Black and brass details
Marble:
White
Black

DIMMER ON CABLE
Integrated Dimmable LED
13W 3000K, 9-21V, 50/60 Hz,
IP20, Class II
Dimmer foot switch on cable

ENERGY LABEL
A ++

IP20 CE E U L

TECHNICAL

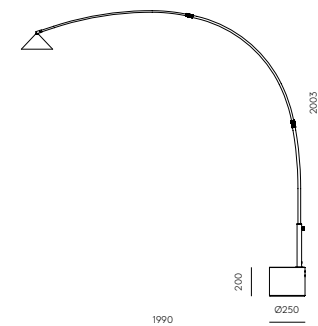

277

HINOŌ



Mallorca, Spain

ABBACUS 753€ (+IVA)

*Preguntar por disponibilidad

Floor lamp

P1258

Designed by Pepe Fornas, 2018

DESCRIPTION

MATERIALS

Steel / Blown Glass

FINISHES

Metal:
Gold

Glass Shade (Included):
Opal
Clear

RECOMMENDED BULB
B005/5W

SPECIFICATIONS (UE)

Bulb G9 (Included)
5W - 2700K
220-240 V, 50/60 Hz
IP20, Class II

ENERGY LABEL

A ++

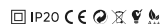

MATERIALES

Acero / Vidrio Soplado

ACABADOS

Metal:
Oro

Cristal (Incluido):
Opal
Transparente

BOMBILLA RECOMENDADA
B005/5W

ESPECIFICACIONES (UE)

Bombilla G9 (Incluida)
5W - 2700K
220-240 V, 50/60 Hz
IP20, Clase II

ETIQUETA ENERGÉTICA

A ++

TECHNICAL

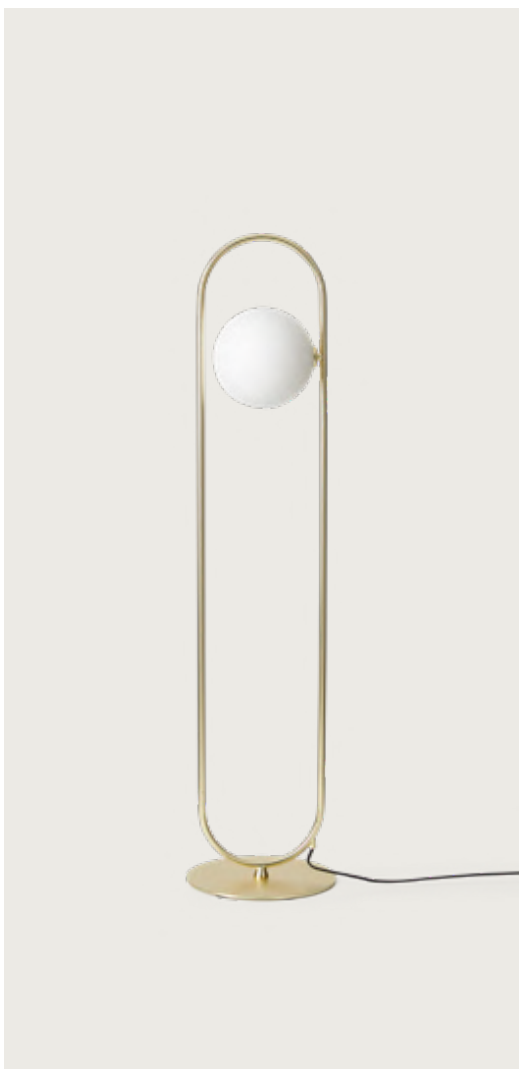
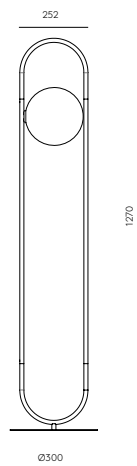

280

ARCTIC 1,133€ (+IVA)

Floor lamp

P1256

Designed by Pepe Fornas, 2020

DESCRIPTION

MATERIALS

Steel

FINISHES

Metal:
Matt Black

Lampholder:
Matt Brass

ACCESSORIES

Image reference accessory 1135
- 30, 60, 90 cm or 1134 - 30,50 or
70 cm (Not included)

Image colours:

1135/30 - Mustard / 1135/60 - Sil-
houette / 1135/90 - Green leaf

RECOMMENDED BULBS

B048 (G125)
B047 (G95)

SPECIFICATIONS (UE)

3 x E27 (Bulbs not included)
220-240 V, 50/60 Hz
IP20, Class II

ENERGY LABEL

A ++

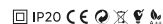

MATERIALES

Acero

ACABADOS

Metal:
Negro Mate

Portalámparas:
Oro Mate

ACCESORIOS

Accesorio imagen 1135 -
30, 60, 90 cm o 1134 - 30,50 O
70 cm (No incluido)

Image colours:

1135/30 - mostaza / 1135/60 -
silhouette / 1135/90 - verde hoja

BOMBILLAS RECOMENDADAS

B048 (G125)
B047 (G95)

ESPECIFICACIONES (UE)

3 x E27 (Bombillas no incluidas)
220-240 V, 50/60 Hz
IP20, Clase II

ETIQUETA ENERGÉTICA

A ++

TECHNICAL

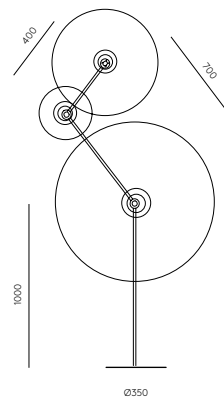

281

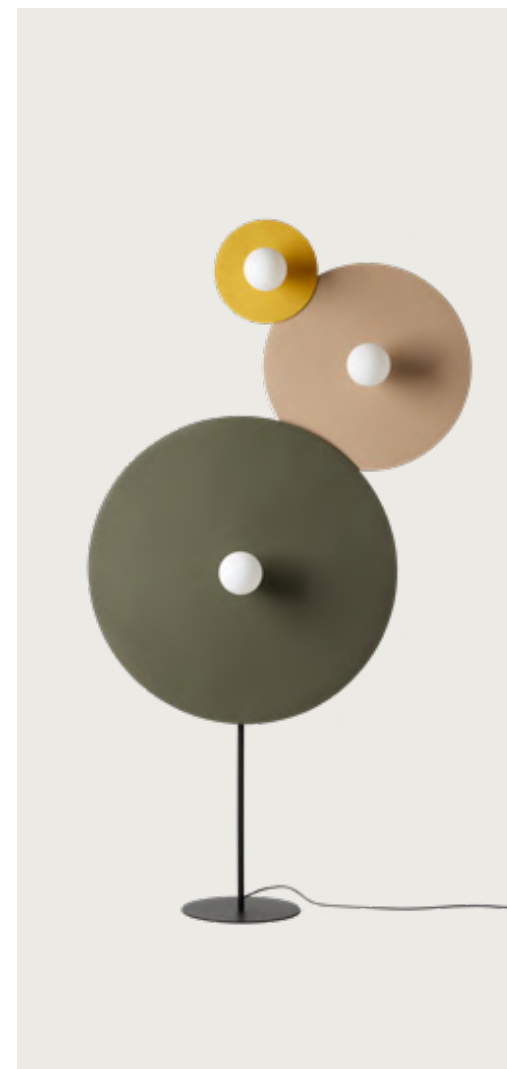

MAHO 380€ (+IVA)

Floor lamp

P1254

Designed by Pepe Fornas, 2021

DESCRIPTION

MATERIALS

Steel

FINISHES

Body:

Gold

Head:

Matt black

Matt Gold

SPECIFICATIONS (UE)

Chip LED 5W- 3000K.

220-240V, 50/60 Hz

IP20, Class I

Touch me dimmer on head

ENERGY LABEL

A ++



MATERIALES

Acero

ACABADOS

Cuerpo:

Negro mate

Cabezal:

Oro Mate

Negro Mate

ESPECIFICACIONES (UE)

Chip LED 5W- 3000K.

220-240V, 50/60 Hz

IP20, Clase I

Regulador Touch me en cabeza

ETIQUETA ENERGÉTICA

A ++

TECHNICAL

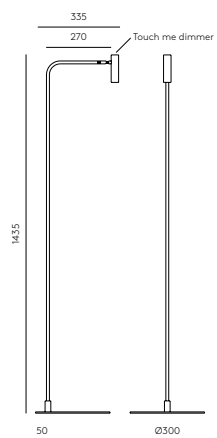

Ljubljana, Slovenia

COT 797€ (+IVA)

Floor lamp

P1251

Designed by AC Studio, 2018

DESCRIPTION

MATERIALS

Steel / Walnut Wood / Cotton

FINISHES

Wood:
Walnut

Shade:
Black
White

RECOMMENDED BULB

B211 (7, 9, 11W)

SPECIFICATIONS (UE)

E27 Max. 60W
(Not included)
220-240 V, 50/60 Hz
IP20, Class II

ENERGY LABEL

A ++



MATERIALES

Acero / Nogal / Algodón

ACABADOS

Madera:
Nogal

Pantalla:
Negra
Blanca

BOMBILLA RECOMENDADA

B211 (7, 9, 11W)

ESPECIFICACIONES (UE)

E27 Max. 60W
(No incluida)
220-240 V, 50/60 Hz
IP20, Clase II

ETIQUETA ENERGÉTICA

A ++

TECHNICAL

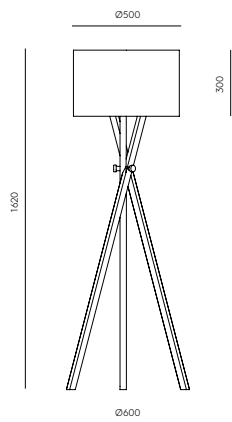

284

FICUS 630€ (+IVA)

Floor lamp

P1243

Designed by JF Sevilla, 2017

DESCRIPTION

MATERIALS

Steel

FINISHES

Metal:
Matt Black

Shade:
Matt Brass

RECOMMENDED BULB

B005/5W

SPECIFICATIONS (UE)

Bulb G9 (Included)
5W - 2700K
220-240 V, 50/60 Hz
IP20, Class II

ENERGY LABEL

A ++

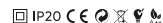

MATERIALES

Acero

ACABADOS

Metal:
Negro Mate

Tulipa:
Oro Mate

BOMBILLA RECOMENDADA

B005/5W

ESPECIFICACIONES (UE)

Bombilla G9 (Incluida)
5W - 2700K
220-240 V, 50/60 Hz
IP20, Clase II

ETIQUETA ENERGÉTICA

A ++

TECHNICAL

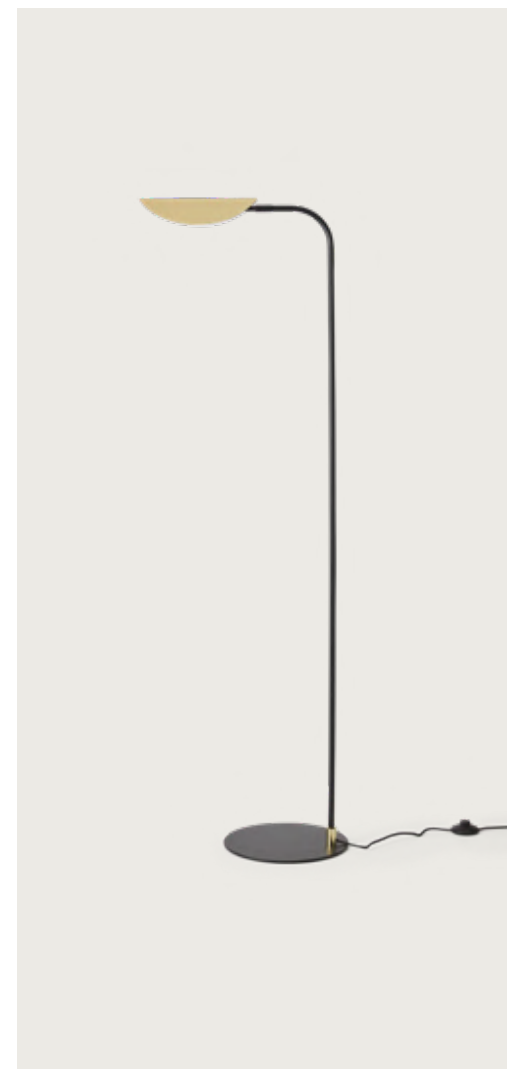
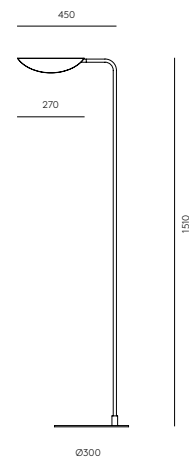

285

OHLALA

Alabastro: 919€ (+IVA)

Cerámica: 755€ (+IVA)

Vidrio: 870€ (+IVA)

Acero: 1,203€ (+IVA)

Floor lamp

P1242

Designed by AC Studio, 2018

DESCRIPTION

MATERIALS

Steel

FINISHES

Body:

Matt Black

Lampholders:

Matt Brass

ACCESSORIES

Accessories not included

Check on p. 362

Image Accessories 1023/20

Bulb B038

SPECIFICATIONS (UE)

2 x E27 Max. 60W

(Not included)

220-240 V, 50/60 Hz

IP20, Class II

ENERGY LABEL

A ++

IP20 CE E

MATERIALES

Acero

ACABADOS

Cuerpo:

Negro Mate

Portalámparas:

Oro

ACCESORIOS

Accesorios no incluidos

Consultar en pág. 362

Accesorios imagen 1023/20

Bombilla B038

ESPECIFICACIONES (UE)

Especificaciones (UE)

2 x E27 Max. 60W (No incluida)

220-240 V, 50/60 Hz

IP20, Clase II

ETIQUETA ENERGÉTICA

A ++

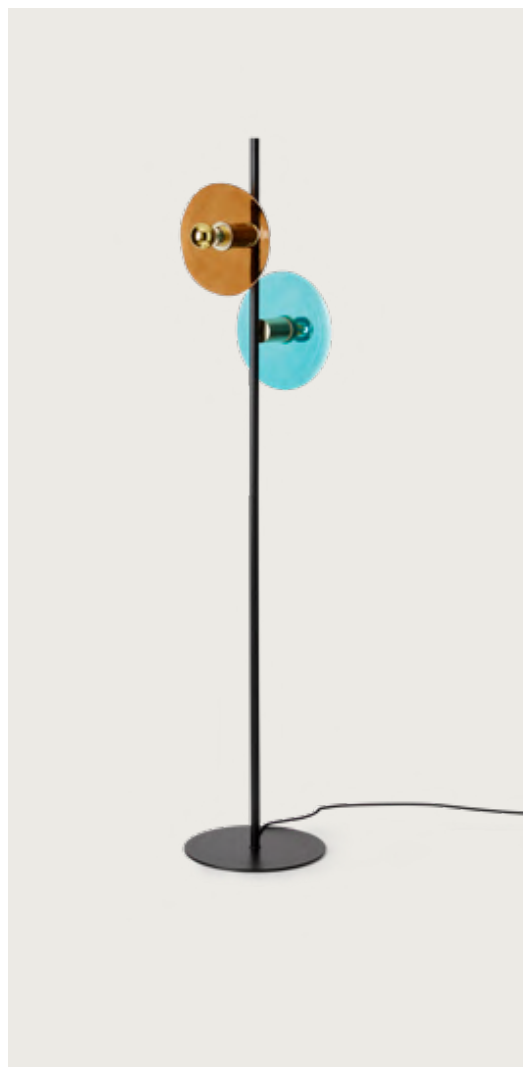

TECHNICAL

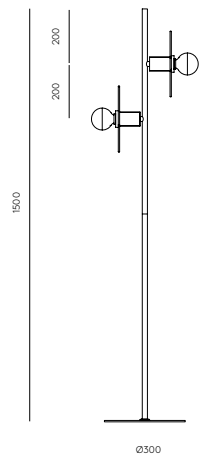

286

ARIO

662€ (+IVA)

Floor lamp

P1234

Designed by AC Studio, 2017

DESCRIPTION

MATERIALS

Steel / Cotton Shade

FINISHES

Metal:

Matt Black

Shade:

Black

Shade included

RECOMMENDED BULB

B211 (7, 9, 11W)

SPECIFICATIONS (UE)

E27 Max. 60W

(Not included)

220-240 V, 50/60 Hz

IP20, Class II

ENERGY LABEL

A ++

IP20 CE E

MATERIALES

Acero / Pantalla Algodón

ACABADOS

Metal:

Negro Mate

Pantalla:

Negra

Pantalla incluida

BOMBILLA RECOMENDADA

B211 (7, 9, 11W)

ESPECIFICACIONES (UE)

E27 Max. 60W

(No incluida)

220-240 V, 50/60 Hz

IP20, Clase II

ETIQUETA ENERGÉTICA

A ++

TECHNICAL

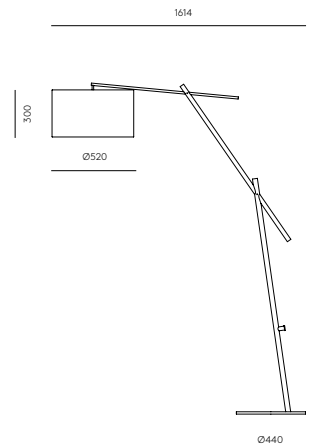

287



Tallin, Estonia



LUCA 732€ (+IVA)

Floor lamp

P1237

Designed by AC Studio, 2017

DESCRIPTION

MATERIALS

Steel / Marble

FINISHES

Metal:
Matt Black

Marble:
White

RECOMMENDED BULB

B211 (7, 9, 11W)

SPECIFICATIONS (UE)

E27 Max. 60W (Not included)
220-240 V, 50/60 Hz
IP20, Class II

ENERGY LABEL

A ++

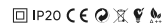

MATERIALES

Acero / Mármol

ACABADOS

Metal:
Negro Mate

Mármol:
Blanco

BOMBILLA RECOMENDADA

B211 (7, 9, 11W)

ESPECIFICACIONES (UE)

E27 Max. 60W (No incluida)
220-240 V, 50/60 Hz
IP20, Clase II

ETIQUETA ENERGÉTICA

A ++

TECHNICAL

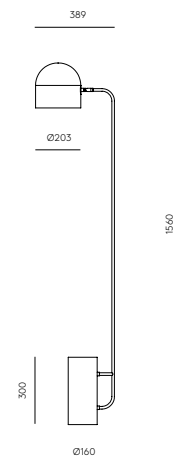

289



NERA 492€ (+IVA)

Floor lamp

P1229

Designed by Pepe Fornas, 2020

DESCRIPTION

MATERIALS

Steel / Wood / Acrylic

FINISHES

Metal:
Matt Black

Wood:
Matt Black

SPECIFICATIONS (UE)

LED COB integrated
8W 3000K (Included)
220-240 V, 50/60 Hz
Touch me - Dimmable

ENERGY LABEL

A ++

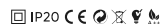

MATERIALES

Acero / Madera / Acrílico

ACABADOS

Metal:
Negro Mate

Madera:
Negro Mate

ESPECIFICACIONES (UE)

COB LED integrado
8W 3000K (Incluida)
220-240 V, 50/60 Hz
Touch me - Regulable

ETIQUETA ENERGÉTICA

A ++

TECHNICAL

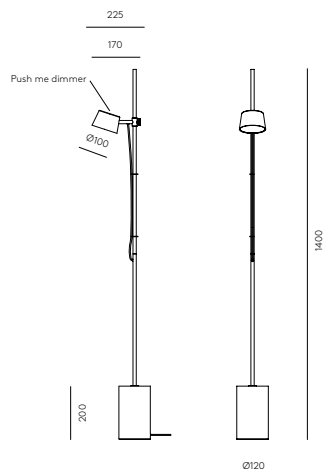

290



ATOM Negro Mate: 597€ (+IVA) Oro Mate: 732€ (+IVA)

Floor lamp

P1214

Designed by AC Studio, 2016

DESCRIPTION

MATERIALS

Steel / Blown Glass

FINISHES

Metal:
Matt Brass
Matt Black

Shade (Included):
Opal
Clear

RECOMMENDED BULB

B005/5W

SPECIFICATIONS (UE)

Bulb G9 (Included)
5W - 2700K
220-240 V, 50/60 Hz
IP20, Class II

ENERGY LABEL

A ++

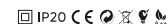

MATERIALES

Acero / Vidrio Soplado

ACABADOS

Metal:
Oro Mate
Negro Mate

Cristal (Incluido):
Opal
Transparente

BOMBILLA RECOMENDADA

B005/5W

ESPECIFICACIONES (UE)

Bombilla G9 (Incluida)
5W - 2700K
220-240 V, 50/60 Hz
IP20, Clase II

ETIQUETA ENERGÉTICA

A ++

TECHNICAL

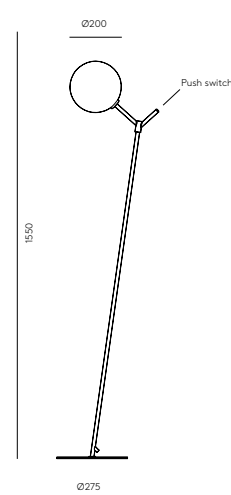

291

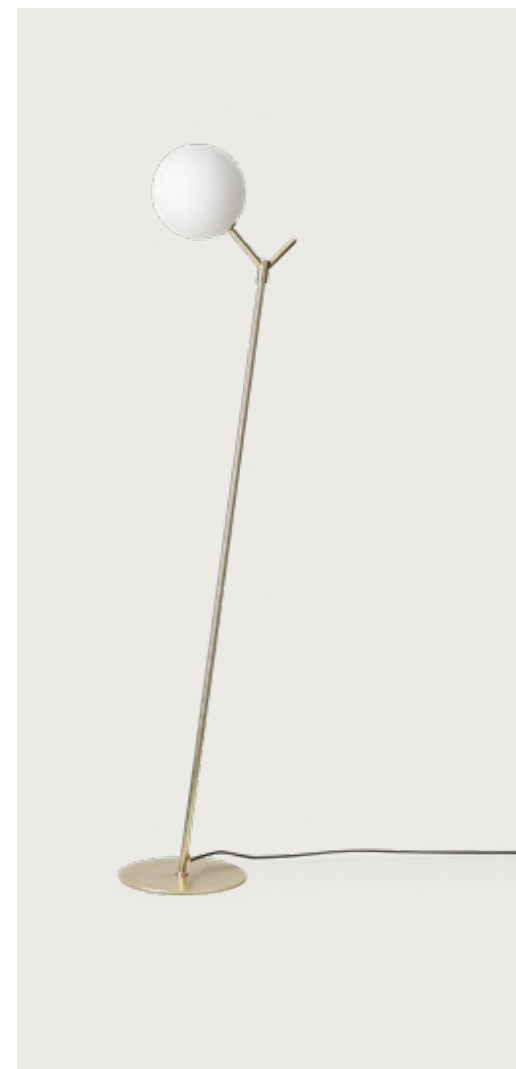

COHEN GOLD 616€ (+IVA)

Floor lamp

P1196

Designed by Jana Chang, 2010

DESCRIPTION

MATERIALS

Steel

FINISHES

COHEN - P1122

Metal:
Chrome

Shade:
Black

Shiny White

COHEN GOLD - P1196

Metal:
Matt Brass

Shade:
Black

Shiny White

RECOMMENDED BULB

B211 (7, 9, 11W)

SPECIFICATIONS (UE)

E27 Max. 60W (Not included)

220-240 V, 50/60 Hz

IP20, Class II

ENERGY LABEL

A ++

IP20 CE RoHS WEEE A++

MATERIALES

Acero

ACABADOS

COHEN - P1122

Metal:
Cromo

Tulipa:
Negro

Blanco Brillo

COHEN GOLD - P1196

Metal:
Oro Mate

Tulipa:
Negro

Blanco Brillo

BOMBILLA RECOMENDADA

B211 (7, 9, 11W)

SPECIFICACIONES (UE)

E27 Max. 60W (No incluida)

220-240 V, 50/60 Hz

IP20, Class II

ETIQUETA ENERGÉTICA

A ++

IP20 CE RoHS WEEE A++

TECHNICAL

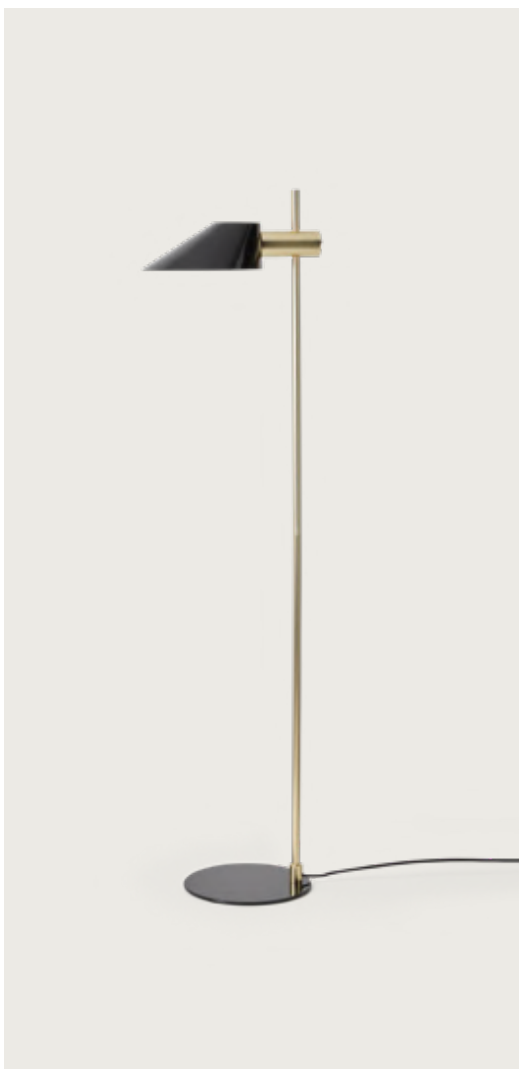
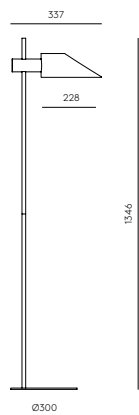

292

MARU 597€ (+IVA)

Floor lamp

P1194

Designed by JF Sevilla, 2015

DESCRIPTION

MATERIALS

Steel

FINISHES

Matt Black - Matt Brass

Matt Black - Matt Black

Metal:
Matt Black - Matt Brass

Matt Black - Matt Black

SPECIFICATIONS (UE)

Integrated Chip Led

3W - 3150K

12 V, 50/60 Hz

IP20, Class II

ENERGY LABEL

A ++

IP20 CE RoHS WEEE A++

MATERIALES

Acero

ACABADOS

Matt Black - Matt Brass

Matt Black - Matt Black

Metal:
Negro Mate - Oro Mate

Negro Mate - Negro Mate

ESPECIFICACIONES (UE)

Chip Led integrado

3W - 3150K

12 V, 50/60 Hz

IP20, Class II

ETIQUETA ENERGÉTICA

A ++

IP20 CE RoHS WEEE A++

TECHNICAL

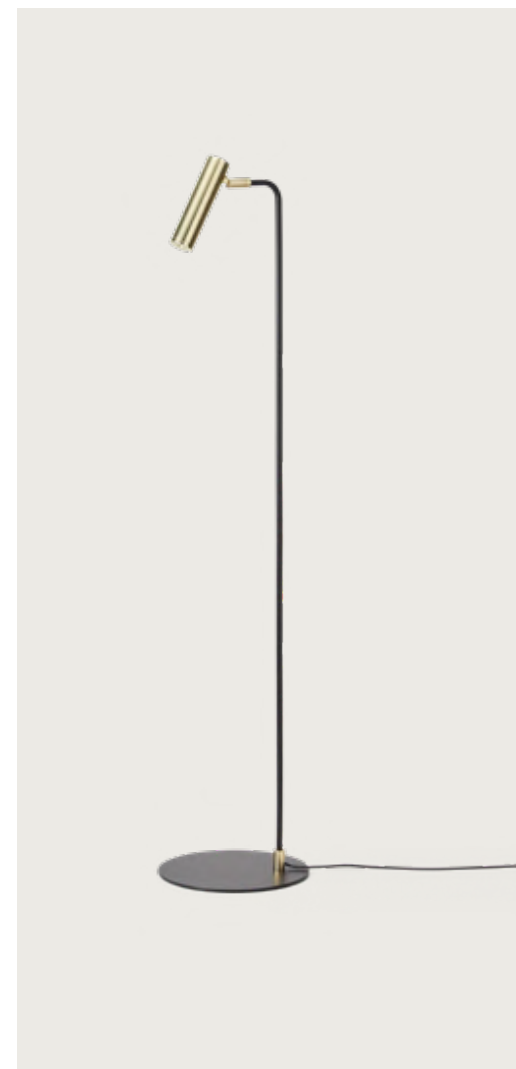
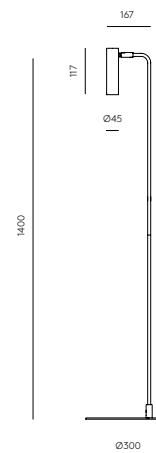

293

BOA 874€ (+IVA)

Floor lamp

P1193

Designed by Fornasevi, 2015

DESCRIPTION

MATERIALS

Steel

FINISHES

LUA - P1147

Metal:

Chrome

Shade:

Red

Black

Shiny White

LUA - P1147

Metal:

Matt Black

Shade:

Black

Matt Brass

RECOMMENDED BULB

B211 (7, 9, 11W)

SPECIFICATIONS (UE)

E27 Max. 60W (Not included)

220-240 V, 50/60 Hz

IP20, Class II

ENERGY LABEL

A ++

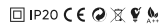

MATERIALES

Acero

ACABADOS

LUA - P1147

Metal:

Cromo

Tulipa:

Rojo

Negro

Blanco Brillo

LUA - P1147

Metal:

Negro Mate

Tulipa:

Negro

Oro Mate

BOMBILLA RECOMENDADA

B211 (7, 9, 11W)

ESPECIFICACIONES (UE)

E27 Max. 60W (No incluida)

220-240 V, 50/60 Hz

IP20, Clase II

ETIQUETA ENERGÉTICA

A ++

TECHNICAL

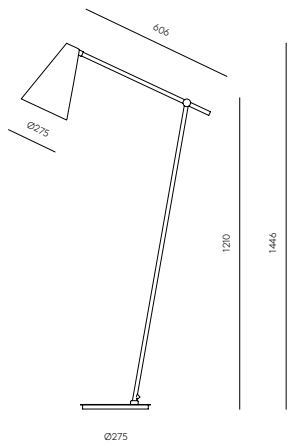

294



TRIPOD 704€ (+IVA)

Floor lamp

P1184

Designed by Estudio Cosi, 2014

DESCRIPTION

MATERIALS

Steel / Cotton Shade

FINISHES

Metal:

Matt Black

Shade:

Matt Black

RECOMMENDED BULB

B211 (7, 9, 11W)

SPECIFICATIONS (UE)

E27 Max. 60W (Not included)

220-240 V, 50/60 Hz

IP20, Class II

ENERGY LABEL

A ++



MATERIALES

Acero / Pantalla Algodón

ACABADOS

Metal:

Negro Mate

Pantalla:

Negro Mate

BOMBILLA RECOMENDADA

B211 (7, 9, 11W)

ESPECIFICACIONES (UE)

E27 Max. 60W (No incluida)

220-240 V, 50/60 Hz

IP20, Clase II

ETIQUETA ENERGÉTICA

A ++

TECHNICAL

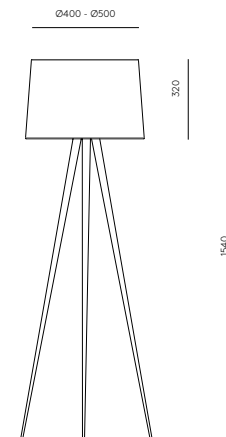

295



DODO 588€ (+IVA)

*Preguntar por disponibilidad

Floor lamp

P1169

Designed by Jana Chang, 2013

DESCRIPTION

MATERIALS

Steel

FINISHES

Metal:
Matt Black
Matt White

RECOMMENDED BULB

B211 (7, 9, 11W)

SPECIFICATIONS (UE)

E27 Max. 60W
(Not included)
220-240 V, 50/60 Hz
IP20, Class II

ENERGY LABEL

A ++



MATERIALES

Acero

ACABADOS

Metal:
Negro Mate
Blanco Mate

BOMBILLA RECOMENDADA

B211 (7, 9, 11W)

ESPECIFICACIONES (UE)

E27 Max. 60W
(No incluida)
220-240 V, 50/60 Hz
IP20, Clase II

ETIQUETA ENERGÉTICA

A ++

TECHNICAL

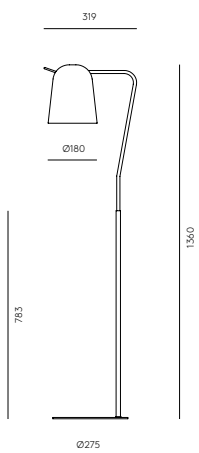

296

RIU 755€ (+IVA)

Floor lamp

P1140

Designed by JF Sevilla, 2012

DESCRIPTION

MATERIALS

Steel / Wood / Fabric / Acrylic

FINISHES

Metal:
Matt Black
Matt White

Wood:

Beech

Shade:

Black

White

RECOMMENDED BULB

B211 (7, 9, 11W)

SPECIFICATIONS (UE)

E27 Max. 60W (Not included)
220-240 V, 50/60 Hz
IP20, Class II

ENERGY LABEL

A ++



MATERIALES

Acero / Madera / Textil / Acrílico

ACABADOS

Metal:
Blanco mate
Negro Mate

Madera:

Haya

Pantalla:

Negro

Blanco

BOMBILLA RECOMENDADA

B211 (7, 9, 11W)

ESPECIFICACIONES (UE)

E27 Max. 60W (No incluida)
220-240 V, 50/60 Hz
IP20, Clase II

ETIQUETA ENERGÉTICA

A ++

TECHNICAL

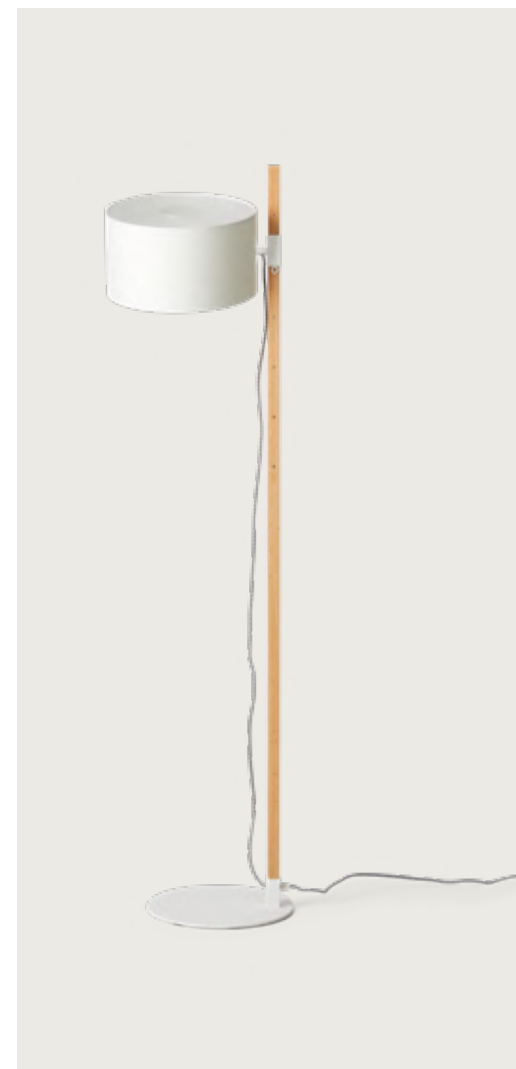
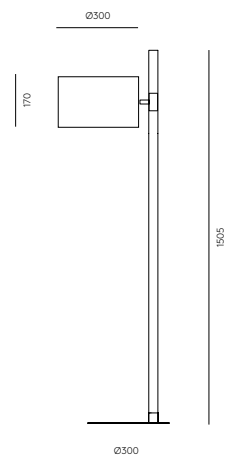

297

HEDRA 558€ (+IVA)

P1159

Designed by AC Studio, 2022

DESCRIPTION

MATERIALS

Steel / Marble

FINISHES

Matt gold

Matt black

Marble:

Matt black

Image Shade:

(not included)

801011/41

RECOMMENDED BULB

B211 (7, 9, 11W)

SPECIFICATIONS (UE)

E27LED regulable 9W 3000K

(incluida), 220-240 V, 50/60 Hz

IP20, Clase II

Dimmer foot switch on cable

ENERGY LABEL

A ++

IP20 CE RoHS WEEE A++

MATERIALES

Acero / Mármol

ACABADOS

Metal:

Oro mate

Negro mate

Mármol:

Negro mate

Pantalla en Imagen:

(no incluida)

BOMBILLA RECOMENDADA

B211 (7, 9, 11W)

ESPECIFICACIONES (UE)

E27LED regulable 9W 3000K

(incluida) 230V, 50/60 Hz

IP20, Clase II

Interruptor y regulador en cable

ETIQUETA ENERGÉTICA

A ++

TECHNICAL

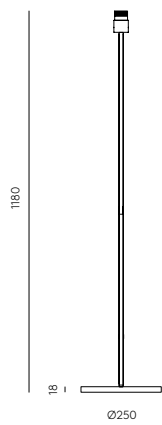



ENDO Cromo: 482€ (+IVA)
Oro Mate: 597€ (+IVA)

Floor lamp

P1156

Designed by Pepe Fornas, 2013

DESCRIPTION

MATERIALS

Steel / Blown Glass

FINISHES

Metal:
Matt Brass
Chrome

Glass Shade (Included):
Opal

RECOMMENDED BULB
B005/SW

SPECIFICATIONS (UE)
Bulb G9 Led - 5W (Included)
2700K
220-240 V, 50/60 Hz
IP20, Class II

ENERGY LABEL
A ++



MATERIALES

Acero / Vidrio Soplado

ACABADOS

Metal:
Oro Mate
Cromo

Cristal (Incluido):
Opal

BOMBILLA RECOMENDADA
B005/SW

ESPECIFICACIONES (UE)
Bombilla G9 Led - 5W (Incluida)
2700K
220-240 V, 50/60 Hz
IP20, Clase II

ETIQUETA ENERGÉTICA
A ++

TECHNICAL

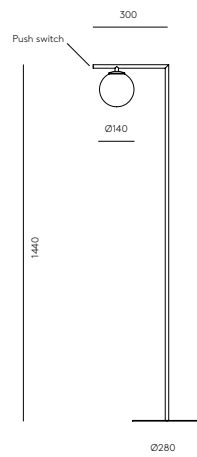

301



ONA 800€ (+IVA)

Floor lamp

P1029

Designed by JI Ballester, 2008

DESCRIPTION

MATERIALS

Steel / Smooth Fabric Shade

FINISHES

Metal:
Satin Nickel
Shade:
Black
White

RECOMMENDED BULB

B211 (7, 9, 11W)

SPECIFICATIONS (UE)

E27 - 2 x Max. 40W
(Not included)
220-240 V, 50/60 Hz
IP20, Class II

ENERGY LABEL

A ++

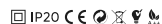

MATERIALES

Acero / Pantalla Textil Lisa

ACABADOS

Metal:
Niquel Satinado
Textil:
Negro
Blanco

BOMBILLA RECOMENDADA

B211 (7, 9, 11W)

ESPECIFICACIONES (UE)

E27 - 2 x Max. 40W
(No incluida)
220-240 V, 50/60 Hz
IP20, Clase II

ETIQUETA ENERGÉTICA

A ++

TECHNICAL

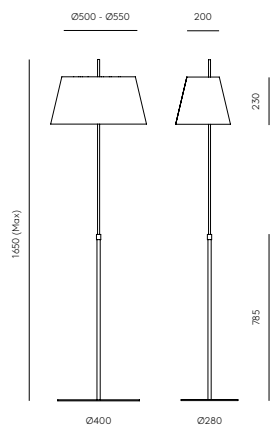

302



TEX 462€ (+IVA)

Floor lamp

P1026

Designed by AC Studio, 2012

DESCRIPTION

MATERIALS

Steel

FINISHES

Metal:
Matt White
Matt Black

IMAGE SHADE

(No included)
151011/45

RECOMMENDED BULB

B211 (7, 9, 11W)

SPECIFICATIONS (UE)

E27 Max. 60W (Not included)
220-240 V, 50/60 Hz
IP20, Class II

ENERGY LABEL

A ++



MATERIALES

Acero

ACABADOS

Metal:
Blanco Mate
Negro Mate

PANTALLA EN IMAGEN

(No incluida)
151011/45

BOMBILLA RECOMENDADA

B211 (7, 9, 11W)

ESPECIFICACIONES (UE)

E27 Max. 60W (No incluida)
220-240 V, 50/60 Hz
IP20, Clase II

ETIQUETA ENERGÉTICA

A ++

TECHNICAL

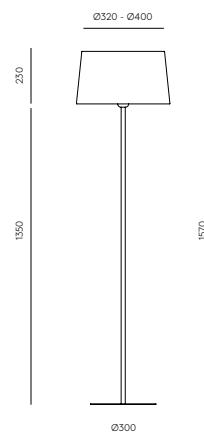

303





Wall

Lamps

306	TURA · A1313	360	DELIE · A1224
308	ELMA · A1312	361	DELIE-L · A1224/L
310	DOUL · A1310	362	HELMET · A1221
312	TANA · A1309	363	HELMET CURVE · A1219
314	DUSSA · A1307	364	LIND · A1220
316	BION · A1306	366	ATOM · A1214
318	ONETA · A1299	367	DOBI · A1207
319	ISON · A1298	369	COSS · A1203
320	YCRO · A1297	370	BIGCOSS · A1203/80
321	PIPE · A1293	372	MARU · A1194
322	HAT · A1291	373	LOTTO · A1176/1175/1174
324	PORTA · A1290	374	DUO · A1170/2
325	MIRO · A1289	376	CALP · A1168
326	FITO · A1286	378	IBRE · A1162
327	AMBOR · A1283	379	VENT · A1161
328	ATIL · A1281	380	FLEXOR · A1151
329	DALT · A1280	381	PILD · A1149
330	FOCUS · A1279	382	AORA · A1129
331	NINO · A1275	384	OSION · A1132
332	NOOI · A1276	385	ALTUN · A1120
334	LYB · A1274	386	FIND · A1110
335	CLOCK · A1273/120	387	READ · A1106
336	CLOCK · A1273	388	CROPI · A1100/56/25
338	BOT · A1272	390	RANG · A1093
339	ALMON · A1264	392	VASTER · A1092
340	XAGO · A1262	393	MINI ROSS · A1063
342	ABBY · A1259/2	394	LASS · A1053 + 1225
344	ABBY · A1259/4	396	FEST · A1053 + 1223
345	ABBY · A1259/6	397	SPIDER · A1053 + 1163
348	ABBACUS · A1258	398	LAOS · A1053 + 1141
349	ERTO · A1257	399	FLAT · A1053 + 1135
350	SUAL · A1255	402	TAN TAN · A1053 + 1125
351	FLEXI LEATHER · A1248	403	KASSY · A1053 + 1097
352	MAHO · A1254	404	WAVE · A1053 + 1094/30
354	FIGUS · A1243	406	ALBA · A1053 + 1096
355	LUCA · A1237	407	LINE · A1053 + 1089
356	LITA · A1230	408	HABAN · A1053 + 1088
357	NERA · A1229	409	GHABAN · A1053 + R1086/1086
358	ALOA · A1227		

TURA 324€ (+IVA)

A1313

Designed by JF Sevilla, 2023

DESCRIPTION

MATERIALS
Steel / Leather

MATERIALES
Metal / Cuero

FINISHES
Metal:
Matt black
Leather:
Black / Brown / Orange

ACABADOS
Metal:
Negro mate
Cuero:
Negro / Marrón / Naranja

SPECIFICATIONS
LED chip 5W 2700K
24V, 50/60Hz
IP20, Class I

ESPECIFICACIONES
Chip LED 5W 2700K
24V, 50/60 Hz
IP20, Clase I

ENERGY LABEL
A ++

ETIQUETA ENERGÉTICA
A ++

Ⓜ IP20 CE RoHS RECYCLED

TECHNICAL

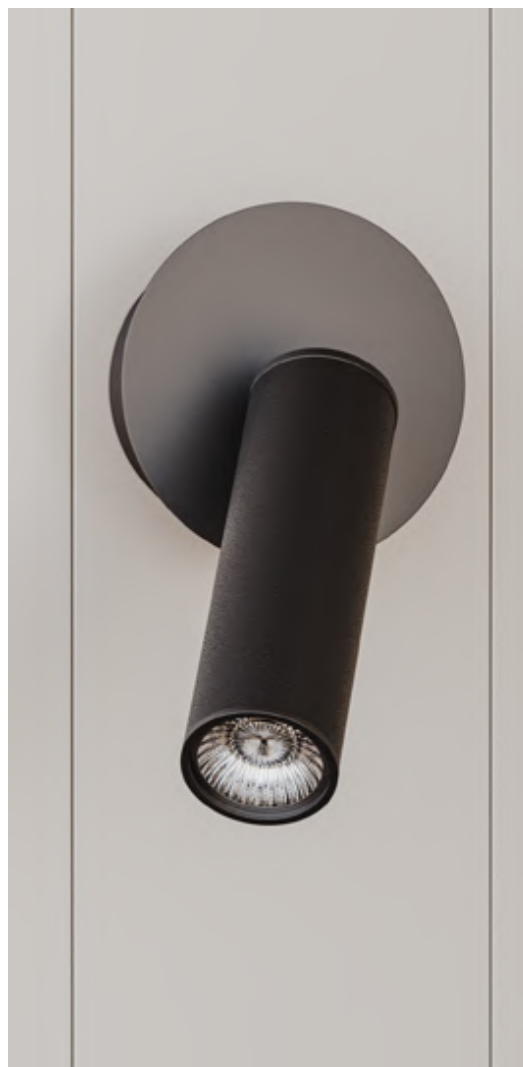
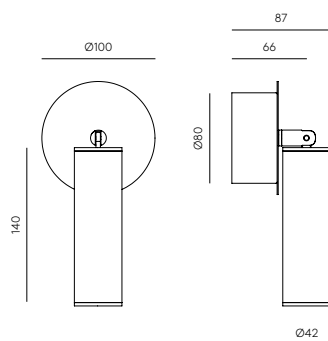

306

Buenos Aires, Argentina



Stockholm, Sweden



ELMA 357€ (+IVA)

Wall lamp

A1312

Designed by Jose Fornas, 2023

DESCRIPTION

MATERIALS

Metal / Glass / Acrylic

FINISHES

Metal: Matte Black / Antique Gold
Glass: Striped glass - Transparent
Acrylic: - Opal

SPECIFICATIONS

LED strip 6W 2700K TRIAC dimmable
24V, 50/60Hz
IP44, Class I

ENERGY LABEL

A ++

MATERIALES

Metal / Vidrio / Acrílico

ACABADOS

Metal: Negro mate / Oro envejecido

Cristal:

Cristal estriado - Transparente
Acrílico - Opal

ESPECIFICACIONES

Tira LED 6W 2700K TRIAC regulable
24V, 50/60 Hz
IP, Clase I

ETIQUETA ENERGÉTICA

A ++

IP20 CE RoHS

TECHNICAL

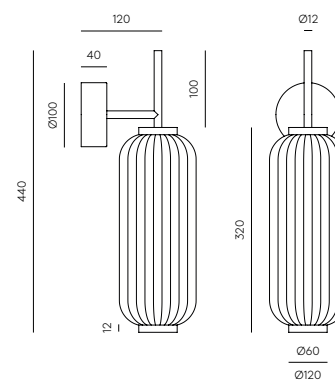

309



DOUL 338€ (+IVA)

A1310

Designed by Agus Gascón, 2023

DESCRIPTION

MATERIALS

Steel / Glass

FINISHES

Metal: Matt black / Matt Brass

Glass: Striped glass - Transparent

SPECIFICATIONS (UE)

G4 LEDs 3W 2700K

Adjustable (Included)

Regulation on cable

220-240V, 50/60Hz

IP44, Class I

ENERGY LABEL

A ++

MATERIALES

Acero / Vidrio

ACABADOS

Metal: Negro mate / Oro envejecido

Cristal: Cristal rayado - Transparente

ESPECIFICACIONES (UE)

G4 LED 3W 2700K

Regulable (Incluida)

Regulación en cable

220-240 V, 50/60 Hz

IP44, Clase I

ETIQUETA ENERGÉTICA

A ++

IP20 CE RoHS

TECHNICAL

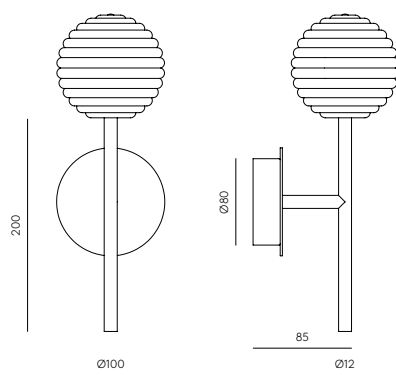

310



TANA 168€ (+IVA)

Wall lamp

A1309

Designed by JF Sevilla, 2022

DESCRIPTION

MATERIALS

Steel

FINISHES

Body:
Matt black

SPECIFICATIONS (UE)

Chip LED 4W - 2700K (Incluida)
Touch me Dimmer
220-240V - 24V - 50/60 Hz
IP20 - Class I

ENERGY LABEL

A ++

MATERIALES

Acero

ACABADOS

Cuerpo:
Negro mate

ESPECIFICACIONES (UE)

Chip LED 4W - 2700K (Incluida)
Regulador Touch me
220-240V - 24V - 50/60 Hz
IP20 - Clase I

ETIQUETA ENERGÉTICA

A ++

⊕ IP20 CE    A++

TECHNICAL

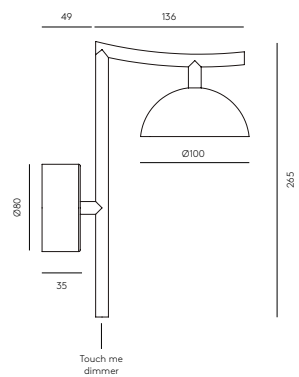

312



Barcelona, Spain

DUSSA 280€ (+IVA)

Wall lamp

A1307

Designed by Pepe Fornas, 2022

DESCRIPTION

MATERIALS

Steel / Marble

FINISHES

Steel:
Matt black
Matt Brass

Marble:

Black
White
Travertine

SPECIFICATIONS (UE)

Led Plate 9W 2700K
Dimmer Dali-Push driver
24 V, 50/60 Hz
IP20 - Class II

ENERGY LABEL

A ++

MATERIALES

Acero / Mármol

ACABADOS

Acero:
Negro mate
Cromo envejecido

Mármol:

Negro
Blanco
Travertino

ESPECIFICACIONES (UE)

Placa LED 9W - 2700K
Regulador por Dali-Push
24 V, 50/60 Hz
IP20, Clase II

ETIQUETA ENERGÉTICA

A ++

IP20 CE RoHS

TECHNICAL

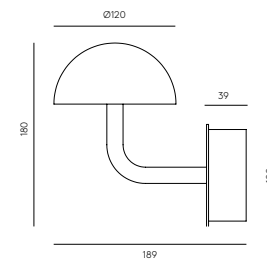

315



BION 277€ (+IVA)

Wall lamp

A1306

Designed by Pepe Fornas, 2022

DESCRIPTION

MATERIALS

Steel

FINISHES

Body:
Matt black
Matt Brass

Shade:
Matt black
Matt white

SPECIFICATIONS (UE)

G9 LED 5W 2700K
Dimmable (Included)
Possibility to add a dimmer interface DALI/PUSH (DALI/230V)
220-240 V, 50/60 Hz
IP20, Class I

ENERGY LABEL

A ++

MATERIALES

Acero

ACABADOS

Cuerpo:
Negro mate
Oro envejecido

Tulipa:
Negro mate
Blanco mate

ESPECIFICACIONES (UE)

G9 LED 5W 2700K
Regulable (Incluida)
Posibilidad de añadir interfaz de regulación DALI/PUSH (DALI/230V)
220-240 V, 50/60 Hz
IP20, Clase I

ETIQUETA ENERGÉTICA

A ++

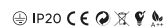

TECHNICAL

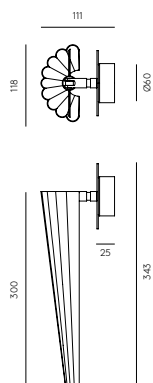

Prague, Czechia

ONETA 312€ (+IVA)

Wall lamp

A1299

Designed by JF Sevilla, 2022

DESCRIPTION

MATERIALS

Steel / Marble / Glass

FINISHES

Metal:
Matt Black
Aged gold

Marble:

White
Black
(Green marble option - extracost)

Glass:

Opal

SPECIFICATIONS (UE)

G4 LED 3W 2700K (included)
220-240 V - 50/60 Hz
Class I - IP20
Touch me dimmer on end of tube

ENERGY LABEL

A ++

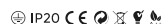

MATERIALES

Acero / Mármol / Vidrio

ACABADOS

Metal:
Negro Mate
Oro envejecido

Mármol:

Blanco
Negro
(Opción mármol verde - sobrecoste)

Vidrio:

Opal

ESPECIFICACIONES (UE)

G4 LED 3W 2700K (incluida) 220-240 V - 50/60 Hz
Clase I - IP20
Regulador Touch me en el tubo

ETIQUETA ENERGÉTICA

A ++

TECHNICAL

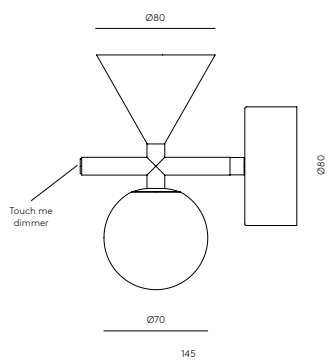

318

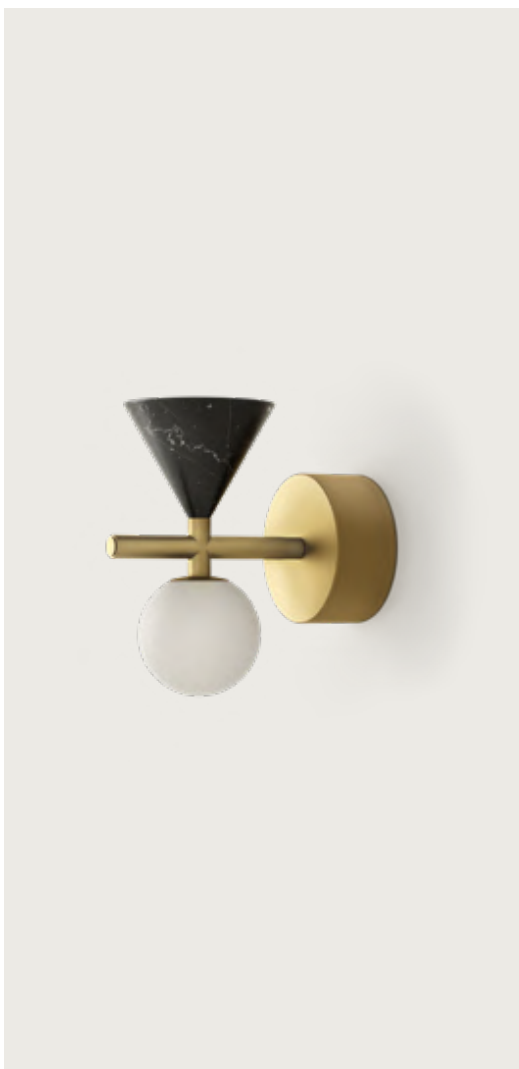

ISON 361€ (+IVA)

Wall lamp

A1298

Designed by Pepe Fornas, 2021

DESCRIPTION

MATERIALS

Steel / Glass

FINISHES

Steel:
Matt Brass
Matt Black

Glass:

Fluted glass

SPECIFICATIONS (UE)

LED Strip 6W - 2700K
TRIAC Dimmable
220-240V - 50/60 Hz
IP20 - Class I

ENERGY LABEL

A ++



MATERIALES

Acero / Vidrio

ACABADOS

Acero:
Oro Mate
Negro Mate

Vidrio:

Estriado

ESPECIFICACIONES (UE)

Tira LED 6W - 2700K
TRIAC Regulable
220-240V - 50/60 Hz
IP20 - Clase I

ETIQUETA ENERGÉTICA

A ++

TECHNICAL

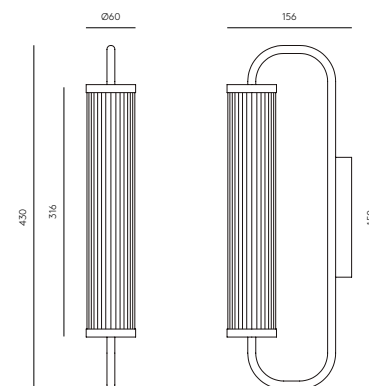

319



YCRO 207€ (+IVA)

Wall lamp

A1297

Designed by JF Sevilla, 2022

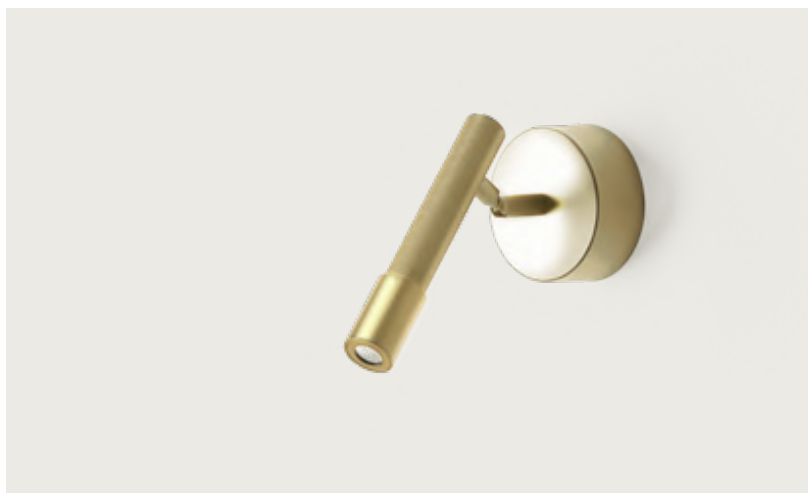

DESCRIPTION

MATERIALS

Steel

FINISHES

Metal:
Matt Black
Matt Brass

SPECIFICATIONS (UE)

Chip LED 8W 3000K
220-240 V - 50/60 Hz
Class I - IP20
Touch me dimmer on head

ENERGY LABEL

A ++

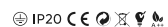

MATERIALES

Acero

ACABADOS

Metal:
Negro Mate
Oro Mate

ESPECIFICACIONES (UE)

Chip LED 8W 3000K
220-240 V - 50/60 Hz
Clase I - IP20
Regulador Touch me en cabeza

ETIQUETA ENERGÉTICA

A ++

TECHNICAL

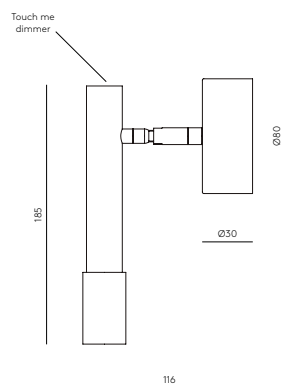

320

PIPE 189€ (+IVA)

Wall lamp

A1293

Designed by AC Studio, 2021



DESCRIPTION

MATERIALS

Steel

FINISHES

Metal:
Matt Black

SPECIFICATIONS (UE)

GU10 LED 3W 3000K (included)
230V, 50/60 Hz
IP20, Class I

ENERGY LABEL

A ++



MATERIALES

Acero

ACABADOS

Metal:
Negro Mate

ESPECIFICACIONES (UE)

GU10 LED 3W 3000K (incluido)
230V, 50/60 Hz
IP20, Clase I

ETIQUETA ENERGÉTICA

A ++

TECHNICAL

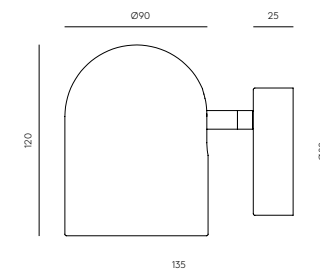

321

Singapore



HAT 492€ (+IVA)

Wall lamp

A1291

Designed by Pepe Fornas, 2021

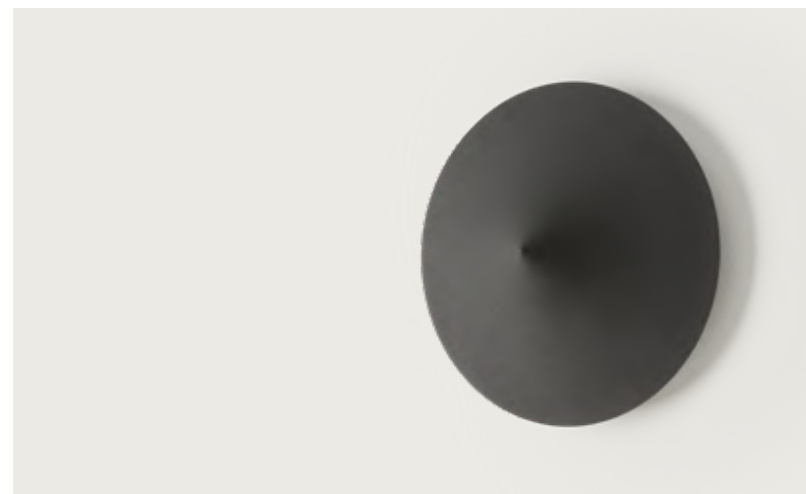

DESCRIPTION

MATERIALS

Steel

FINISHES

Metal:
Textured matt black
Textured matt white
Matt brass

SPECIFICATIONS (UE)

3 x G9 LED 5W 2700K
(included)
24 V, 50/60 Hz,
IP20, Class I

ENERGY LABEL

A ++



TECHNICAL

MATERIALES

Acero

ACABADOS

Metal:
Oro mate
Negro mate texturizado
Blanco mate texturizado

ESPECIFICACIONES (UE)

3 x G9 LED 5W 2700K
(included)
24 V, 50/60 Hz,
IP20, Class I

ETIQUETA ENERGÉTICA

A ++

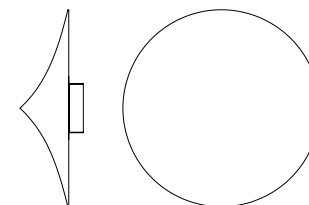

140

Ø400

PORTA 333€ (+IVA)

Wall lamp

A1290
Designed by Estudi Hac, 2021



DESCRIPTION

MATERIALS

Steel / Glass

FINISHES

Metal:
Matt Black

Glass:
Smoked grey

SPECIFICATIONS (UE)

9W LED plate - 3000K
Dimmable
220-240 V - 24V, 50/60 Hz,
IP20, Class I

ENERGY LABEL

A ++

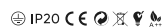

MATERIALES

Acero / Vidrio

ACABADOS

Metal:
Negro Mate

Vidrio:
Fumé gris

ESPECIFICACIONES (UE)

Placa LED 9W - 3000K
Regulable
220-240 V - 24V, 50/60 Hz,
IP20, Clase I

ETIQUETA ENERGÉTICA

A ++

TECHNICAL

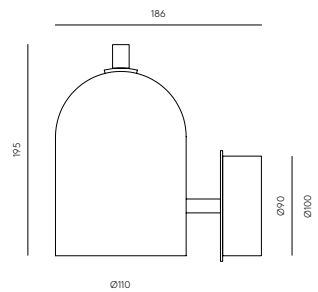

MIRO Alabastro: 368€ (+IVA) Cerámica: 312€ (+IVA) Vidrio: 343€ (+IVA) Acero: 301€ (+IVA)

Wall lamp

A1289
Designed by AC Studio, 2021



DESCRIPTION

MATERIALS

Steel / Blown Glass

FINISHES

Metal:
Matt black

Shade:
Opal

COMPATIBLE ACCESSORIES (NOT INCLUDED)

Alabaster 1096 (20 cm)
Ceramic 1097/20 (20 cm)
Metalic disc 1289/20 (15 cm)

RECOMMENDED BULB

B005/5W

SPECIFICATIONS (UE)

G9 LED (included) 5W 2700K
220-240V, 50/60 Hz
IP20, Class I

ENERGY LABEL

A ++



MATERIALES

Acero / Vidrio Soplado

ACABADOS

Metal:
Negro mate

Túlipa:
Opal

ACCESORIOS COMPATIBLES (NO INCLUIDOS)

Alabastro 1096 (20 cm)
Cerámica 1097/20 (20 cm)
Disco Metálico 1289/20 (15 cm)

BOMBILLA RECOMENDADA

B005/5W

ESPECIFICACIONES (UE)

G9 LED (incluida) 5W 2700K
220-240V, 50/60 Hz
IP20, Clase I

ETIQUETA ENERGÉTICA

A ++

TECHNICAL

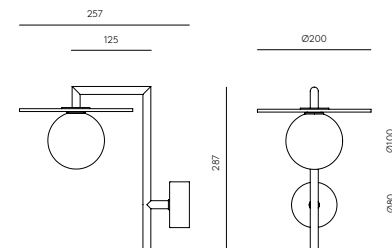

FITO 459€ (+IVA)

Wall lamp

A1286

Designed by Pepe Fornas, 2020

DESCRIPTION

MATERIALS

Steel / Marble

FINISHES

Metal: Matt Black

Base: Black Marble

Rack: Matt Brass

RECOMMENDED BULB

T8/14W

SPECIFICATIONS (UE)

T8 Led 14W (Included)

3000K, 220-240 V, 50/60 Hz

IP20, Class II

ENERGY LABEL

A ++



MATERIALES

Acero / Mármol

ACABADOS

Metal: Negro Mate

Base: Mármol Negro

Rejilla: Oro Mate

BOMBILLA RECOMENDADA

T8/14W

ESPECIFICACIONES (UE)

T8 Led 14W (Incluido)

3000K, 220-240 V, 50/60 Hz

IP20, Clase II

ETIQUETA ENERGÉTICA

A ++

TECHNICAL

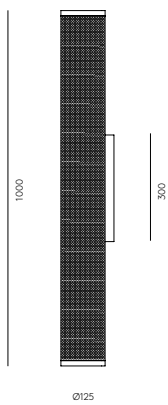

326



AMBOR 219€ (+IVA) *Preguntar por disponibilidad

Wall lamp

A1283

Designed by Pepe Fornas, 2019

DESCRIPTION

MATERIALS

Steel / Acrylic Glass

FINISHES

Metal: Matt Black

Matt Brass

Diffuser: Opal

RECOMMENDED BULB

B005

SPECIFICATIONS (UE)

G9 Led Bulbs (Included)

3 x 3W - 3000K Dimmable

220-240 V, 50/60 Hz

IP20, Class I

ENERGY LABEL

A ++



MATERIALES

Acero / Acrílico

ACABADOS

Metal: Negro Mate

Oro Mate

Difusor: Opal

BOMBILLA RECOMENDADA

B005

ESPECIFICACIONES (UE)

Bombillas G9 Led (Incluidas)

3 x 3W - 3000K Regulable

220-240 V, 50/60 Hz

IP20, Clase I

ETIQUETA ENERGÉTICA

A ++

TECHNICAL

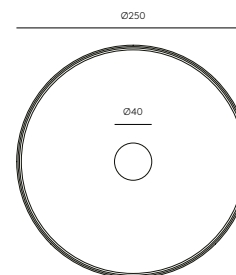

327



ATIL 501€ (+IVA)

Wall lamp

A1281

Designed by Pepe Fornas, 2019

DESCRIPTION

MATERIALS

Steel / Glass

FINISHES

Metal:
Matt Black
Matt Brass

Shade:
Opal

RECOMMENDED BULB

B005/5W

SPECIFICATIONS (UE)

G9 Led Bulbs (Included)
2 x 5W - 2700K
220-240 V, 50/60 Hz
IP20, Class I

ENERGY LABEL

A ++



MATERIALES

Acero / Vidrio

ACABADOS

Metal:
Negro Mate
Oro Mate

Tulipa:
Opal

BOMBILLA RECOMENDADA

B005/5W

ESPECIFICACIONES (UE)

Bombillas G9 Led (Incluidas)
2 x 5W - 2700K
220-240 V, 50/60 Hz
IP20, Clase I

ETIQUETA ENERGÉTICA

A ++



TECHNICAL

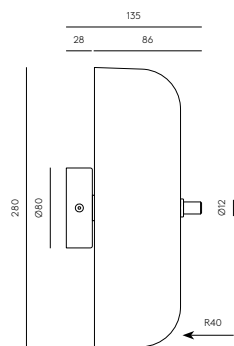

328

DALT 298€ (+IVA)

Wall lamp

A1280

Designed by Pepe Fornas, 2019

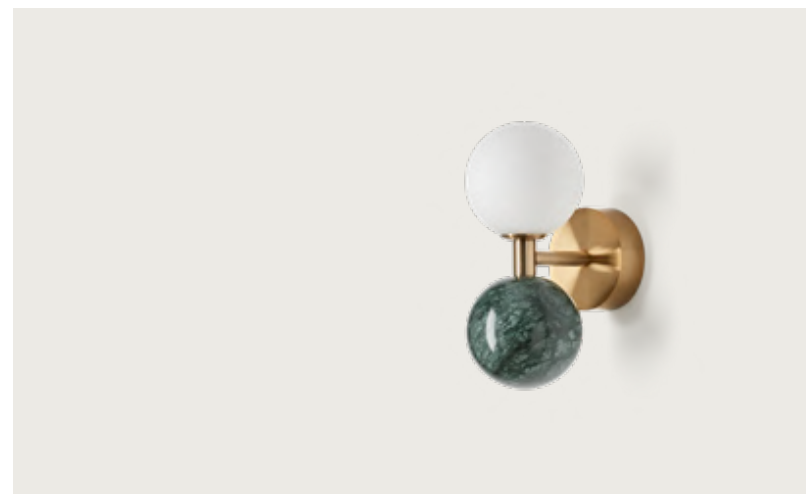

DESCRIPTION

MATERIALS

Steel / Marble / Glass

FINISHES

Body:
Matt Black
Aged Gold

Marble:

Black
White
Green

Glass Shade:
Opal

POSSIBLE MODIFICATIONS

Marble Finishes - extracost

RECOMMENDED BULB

B005/5W

SPECIFICATIONS (UE)

Bulb G9 Led (Included)
5W - 2700K
220-240 V, 50/60 Hz
IP20, Class I

ENERGY LABEL

A ++

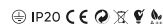

MATERIALES

Acero / Mármol / Vidrio

ACABADOS

Metal:
Negro Mate
Oro Envejecido

Mármol:

Negro
Blanco
Verde

Tulipa:
Opal

MODIFICACIONES POSIBLES

Acabado Mármol - sobrecoste

BOMBILLA RECOMENDADA

B005/5W

ESPECIFICACIONES (UE)

Bombilla G9 Led (Incluida)
5W - 2700K
220-240 V, 50/60 Hz
IP20, Clase I

ETIQUETA ENERGÉTICA

A ++

TECHNICAL

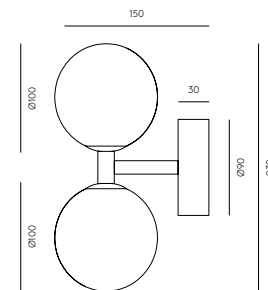

329

FOCUS 270€ (+IVA)

*Cabeza de alabastro 63€ (+IVA)

Wall lamp

A1279

Designed by Pepe Fornas, 2019



DESCRIPTION

MATERIALS

Steel / Aluminium or Alabaster

FINISHES

Body:
Matt Black

Head:
Aged Gold
Anthracite
Alabaster

POSSIBLE MODIFICATIONS

Alabaster head (Extra charge)

RECOMMENDED BULB

B161

SPECIFICATIONS (UE)

Bulb GU10 Led (Included)
5W - 2700K
220-240 V, 50/60 Hz
IP20, Class I

ENERGY LABEL

A ++

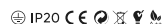

MATERIALES

Acero / Aluminio o Alabastro

ACABADOS

Cuerpo:
Negro Mate

Cabeza:
Oro Viejo
Antracita
Alabastro

MODIFICACIONES POSIBLES

Cabezal Alabastro (Sobrecoste)

BOMBILLA RECOMENDADA

B161

ESPECIFICACIONES (UE)

Bombilla GU10 Led (Incluida)
5W - 2700K
220-240 V, 50/60 Hz
IP20, Clase I

ETIQUETA ENERGÉTICA

A ++

TECHNICAL

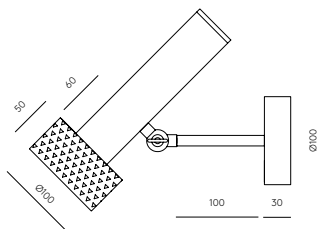

330

NINO 361€ (+IVA)

Wall lamp

A1275

Designed by JF Sevilla, 2021

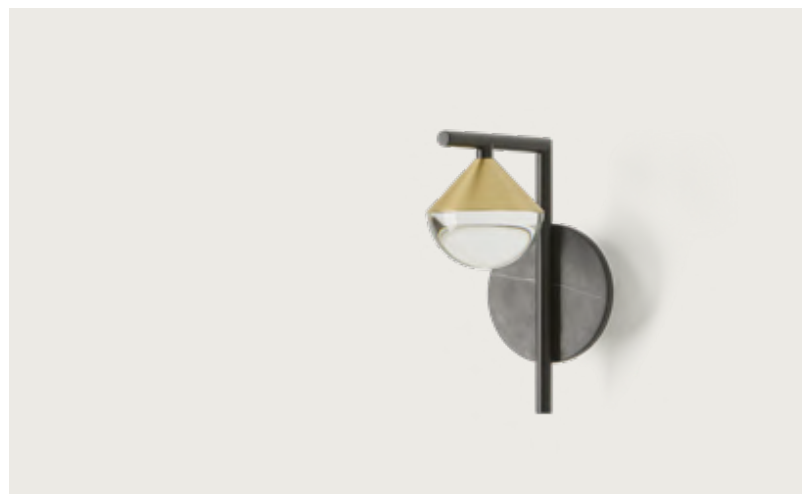

DESCRIPTION

MATERIALS

Steel / Marble / Glass

FINISHES

Metal:
Matt Black

Details:
Matt gold

Marble:
Matt black

Glass:
Opal

SPECIFICATIONS (UE)

LED Chip 7W
2700K Dimmable
24 V, 50/60 Hz
IP20, Class I

ENERGY LABEL

A ++

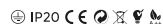

MATERIALES

Acero / Mármol / Vidrio

ACABADOS

Metal:
Negro Mate

Detalles:
Oro mate

Mármol:
Negro mate

Vidrio:
Óptico

ESPECIFICACIONES (UE)

Chip LED 7W
2700K Regulable
24 V, 50/60 Hz
IP20, Clase I

ETIQUETA ENERGÉTICA

A ++

TECHNICAL

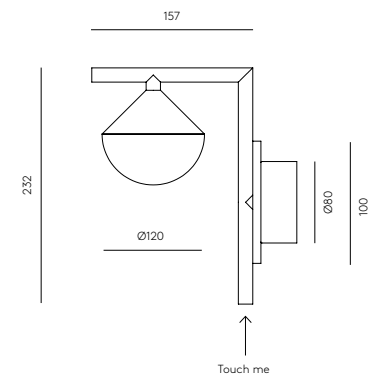

331



Nicosia, Cyprus

NOOI 261€ (+IVA)

Wall lamp

A1276
Designed by Pepe Fornas, 2022

DESCRIPTION

MATERIALS
Linen / Steel / Acrylic

FINISHES
Metal:
Matt Black

Shade:
Cream Linen textile

Acrylic:
Opal

SPECIFICATIONS (UE)
T8 5W Dimmable - 3000K
Triac dimmable
220-240V, 50/60Hz
IP20, Class I

ENERGY LABEL
A ++

⊕ IP20 CE A++

MATERIALES
Lino / Metal / Acrílico

ACABADOS
Metal:
Negro mate

Tulipa:
Textil Lino Crema

Acrílico:
Opal

ESPECIFICACIONES (UE)
T8 5W Regulable - 3000K
Regulador Triac
220-240 V, 50/60 Hz
IP20, Clase I

ETIQUETA ENERGÉTICA
A ++

TECHNICAL

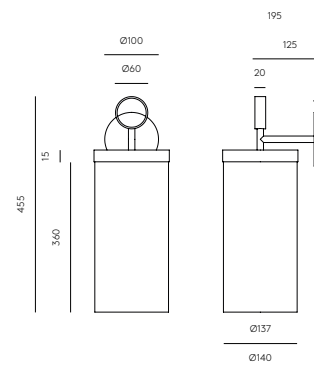

LYB 473€ (+IVA)

Wall lamp

A1274

Designed by Pepe Fornas, 2019

DESCRIPTION

MATERIALS

Steel

FINISHES

Metal:
Matt Black

TOUCH ME DIMMABLE

SPECIFICATIONS (UE)

Led integrated 5W,
3000K
12 V, 50/60 Hz
IP20, Class I

ENERGY LABEL

A ++



MATERIALES

Acero

ACABADOS

Metal:
Negro Mate

TOUCH ME REGULABLE

ESPECIFICACIONES (UE)

Led integrado 5W,
3000K
12 V, 50/60 Hz
IP20, Clase I

ETIQUETA ENERGÉTICA

A ++

TECHNICAL

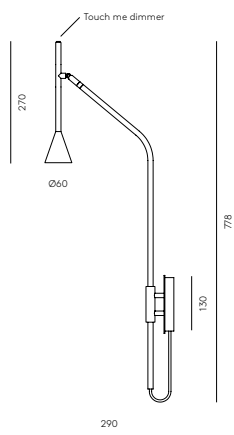

334

CLOCK 399€ (+IVA)

Wall lamp

A1273 /120

Designed by Pepe Fornas, 2019

DESCRIPTION

MATERIALS

Steel

FINISHES

Metal:
Matt Black
Matt Brass

SPECIFICATIONS (UE)

Strip Led integrated
24W - 2700K TRIAC dimmable
12 V, 50/60 Hz
IP20, Class I

ENERGY LABEL

A ++

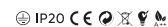

MATERIALES

Acero

ACABADOS

Metal:
Negro Mate
Oro Mate

ESPECIFICACIONES (UE)

Tira Led integrada
24W - 2700K TRIAC regulable
12 V, 50/60 Hz
IP20, Clase I

ETIQUETA ENERGÉTICA

A ++

TECHNICAL

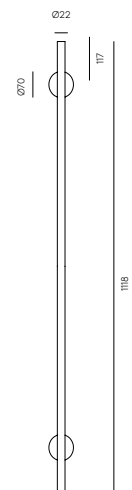

335

CLOCK 338€ (+IVA)

A1273

Designed by Pepe Fornas, 2019

DESCRIPTION

MATERIALS

Steel

FINISHES

Metal:
Matt Black

SPECIFICATIONS (UE)

Strip Led integrated
24W - 2700K TRIAC dimmable
12 V, 50/60 Hz
IP20, Class I

ENERGY LABEL

A ++

⊕ IP20 CE    

MATERIALES

Acero

ACABADOS

Metal:
Negro Mate

ESPECIFICACIONES (UE)

Tira Led integrada
24W - 2700K TRIAC Regulable
12 V, 50/60 Hz
IP20, Clase I

ETIQUETA ENERGÉTICA

A ++

TECHNICAL

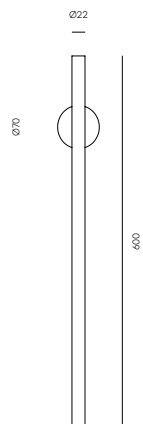

336



BOT 203€ (+IVA)

Wall lamp

A1272

Designed by Pepe Fornas, 2019

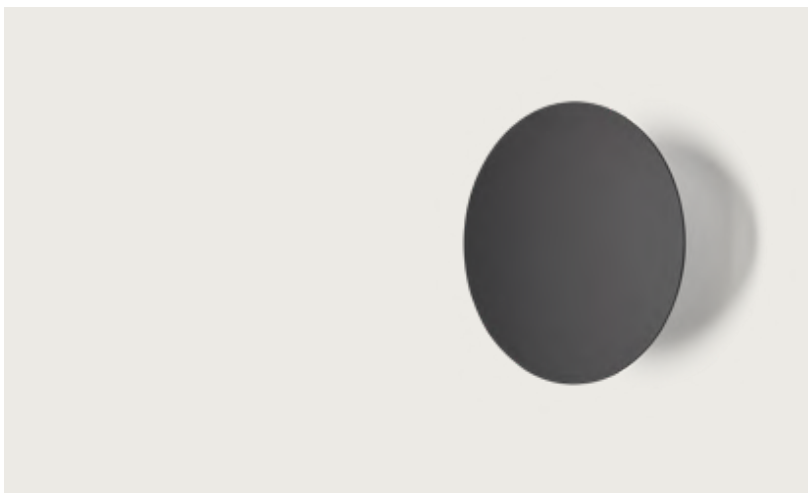

DESCRIPTION

MATERIALS

Steel

FINISHES

Metal:
Matt Black
Matt White

SPECIFICATIONS (UE)

Led integrated
18W - 2700K
12 V, 50/60 Hz
IP20, Class I

ENERGY LABEL

A ++

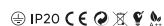

MATERIALES

Acero

ACABADOS

Metal:
Negro Mate
Blanco Mate

ESPECIFICACIONES (UE)

Led Integrado
18W - 2700K
12 V, 50/60 Hz
IP20, Clase I

ETIQUETA ENERGÉTICA

A ++

TECHNICAL

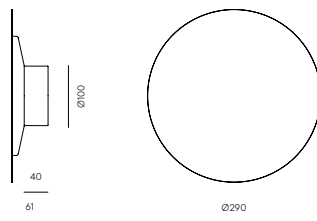

338

ALMON 462€ (+IVA)

Wall lamp

A1264

Designed by Pepe Fornas, 2018

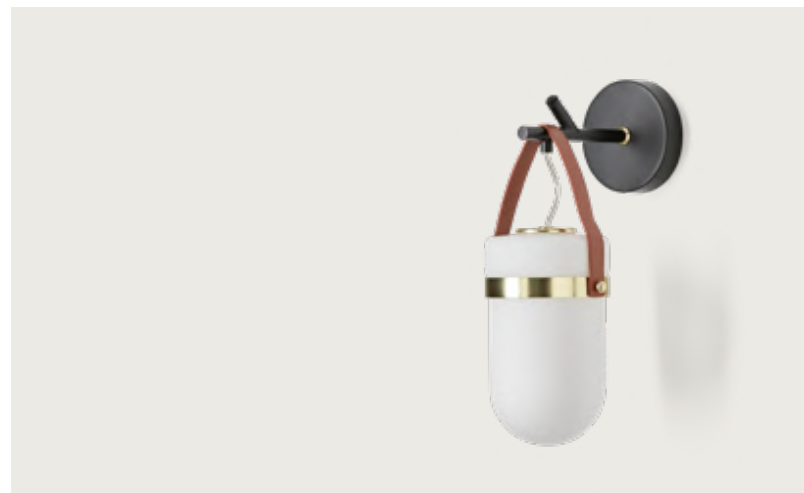

DESCRIPTION

MATERIALS

Steel / Blown Glass / Leather

FINISHES

Metal:
Matt Black
Details:
Matt Brass
Leather:
Brown

RECOMMENDED BULB

B005/5W

SPECIFICATIONS (UE)

Bulb G9 Led (Incluido)
5W - 2700K
220-240 V, 50/60 Hz
IP20, Class I

ENERGY LABEL

A ++



MATERIALES

Acero / Vidrio soplado / Cuero

ACABADOS

Metal:
Negro Mate
Detalles:
Oro mate
Piel:
Marrón

BOMBILLA RECOMENDADA

B005/5W

ESPECIFICACIONES (UE)

Bombilla G9 Led (Incluida)
5W - 2700K
220-240 V, 50/60 Hz
IP20, Clase I

ETIQUETA ENERGÉTICA

A ++

TECHNICAL

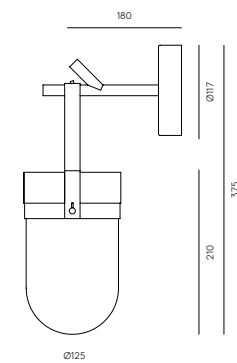

339



XAGO 490€ (+IVA)

Wall lamp

A1262

Designed by Agus Gascón, 2023

DESCRIPTION

MATERIALS

Steel / Acrylic

FINISHES

Metal: Matt Black/ Matt Brass

Acrylic: Opal

SPECIFICATIONS (UE)

S14D LED 16W 2700K TRIAC
dimmable
220-240V, 50/60Hz
IP20, Class I

ENERGY LABEL

A ++

MATERIALES

Metal / Acrílico

ACABADOS

Metal: Negro mate / Oro envejecido

Acrílico: Opal

ESPECIFICACIONES (UE)

S14D LED 16W 2700K TRIAC
regulable
220-240V, 50/60 Hz
IP20, Clase I

ETIQUETA ENERGÉTICA

A ++

IP20 CE RoHS REACH

TECHNICAL

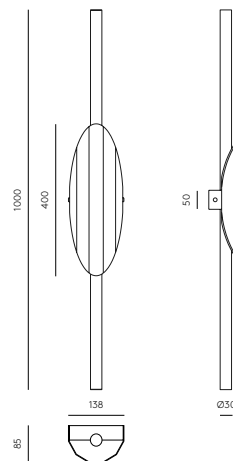

ABBY 700€ (+IVA)

*Modelo personalizable

A1259/2

Designed by AC Studio, 2022

DESCRIPTION

MATERIALS

Steel

FINISHES

Steel:
Matt black
Matt Brass

SPECIFICATIONS (UE)

2 x E27 Max. 60W
(Not included)
220-240 V, 50/60 Hz
IP20, Class I

Accesorios and bulbs not included

ENERGY LABEL

A ++

MATERIALES

Acero

ACABADOS

Acero:
Negro mate
Oro envejecido

ESPECIFICACIONES (UE)

2 x E27 Max. 60W
(No incluida)
220-240 V, 50/60 Hz
IP20, Clase I

Accesorios y bombillas no incluidas

ETIQUETA ENERGÉTICA

A ++

IP20 CE

TECHNICAL

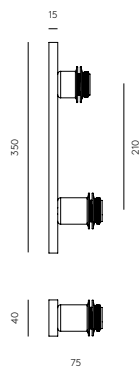

Seville, Spain



ABBY 1,001€ (+IVA)

*Modelo personalizable

Wall lamp

A1259/4
Designed by Pepe Fornas, 2018



DESCRIPTION

MATERIALS

Steel

FINISHES

Steel:
Matt black
Matt Brass

SPECIFICATIONS (UE)

4 x E27 Max. 60W
(Not included)
220-240 V, 50/60 Hz
IP20, Class I

Accessories and bulbs not included

ENERGY LABEL

A ++



MATERIALES

Acero

ACABADOS

Acero:
Negro mate
Oro envejecido

ESPECIFICACIONES (UE)

4 x E27 Max. 60W
(No incluida)
220-240 V, 50/60 Hz
IP20, Clase I

Accesorios y bombillas no incluidas

ETIQUETA ENERGÉTICA

A ++

TECHNICAL

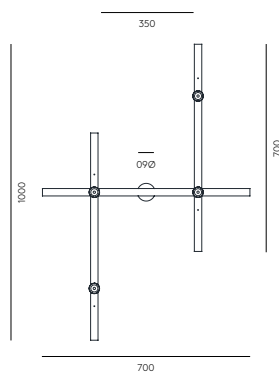

ABBY 1,684€ (+IVA)

*Modelo personalizable

Wall lamp

A1259/6
Designed by Pepe Fornas, 2018



DESCRIPTION

MATERIALS

Steel

FINISHES

Steel:
Matt black
Matt Brass

Accessories:

Check page 362

Image composition:

1132 * 2
1038/35
1038/25
1096/35
1097/20

SPECIFICATIONS (UE)

6 x E27 Max. 60W
(Not included)
220-240 V, 50/60 Hz
IP20, Class I

Accessories and bulbs not included

ENERGY LABEL

A ++



MATERIALES

Acero

ACABADOS

Metal:
Negro mate
Oro envejecido

Accesorios:

Consultar pág. 362

Composición imagen:

1132 * 2
1038/35
1038/25
1096/35
1097/20

ESPECIFICACIONES (UE)

6 x E27 Max. 60W
(No incluida)
220-240 V, 50/60 Hz
IP20, Clase I

Accesorios y bombillas no incluidas

ETIQUETA ENERGÉTICA

A ++

TECHNICAL

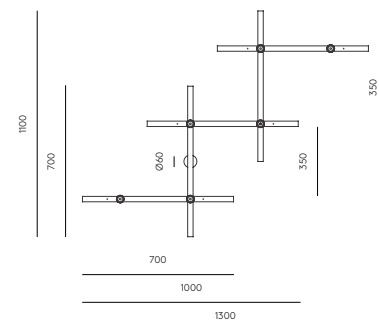

ABBY



ABBACUS 424€ (+IVA)

Wall lamp

A1258

Designed by Pepe Fornas, 2018

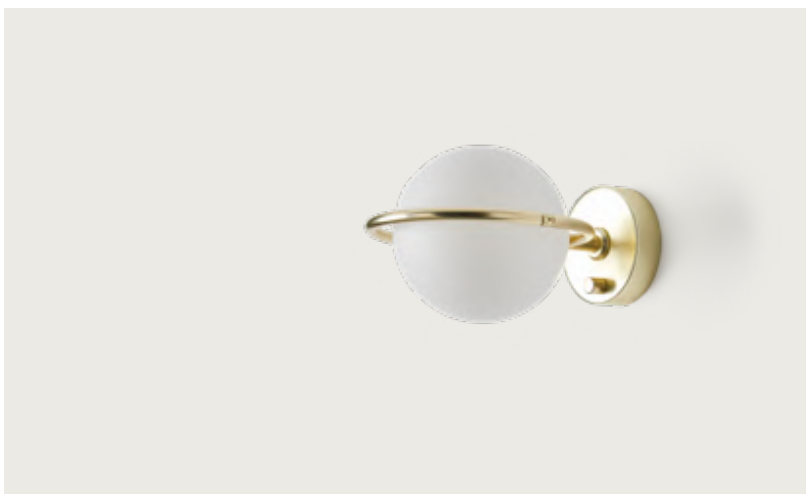

DESCRIPTION

MATERIALS

Steel / Blown Glass

FINISHES

Metal:
Matt black
Matt Brass

Glass Shade (Included):
Opal
Clear

SPECIFICATIONS (UE)

Bulb G9 (Included)
5W - 2700K
220-240 V, 50/60 Hz
IP20, Class I

ENERGY LABEL

A ++



MATERIALES

Acero / Vidrio Soplado

ACABADOS

Metal:
Negro mate
Oro mate

Cristal (Incluido):
Opal
Transparente

ESPECIFICACIONES (UE)

Bombilla G9 (Incluida)
5W - 2700K
220-240 V, 50/60 Hz
IP20, Clase I

ETIQUETA ENERGÉTICA

A ++

TECHNICAL

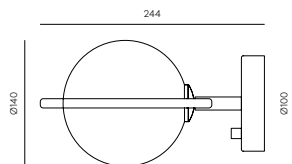

348

ERTO Alabastro: 462€ (+IVA) Cerámica: 406€ (+IVA) Vidrio: 438€ (+IVA) Acero: 399€ (+IVA)

Wall lamp

A1257

Designed by AC Studio, 2020

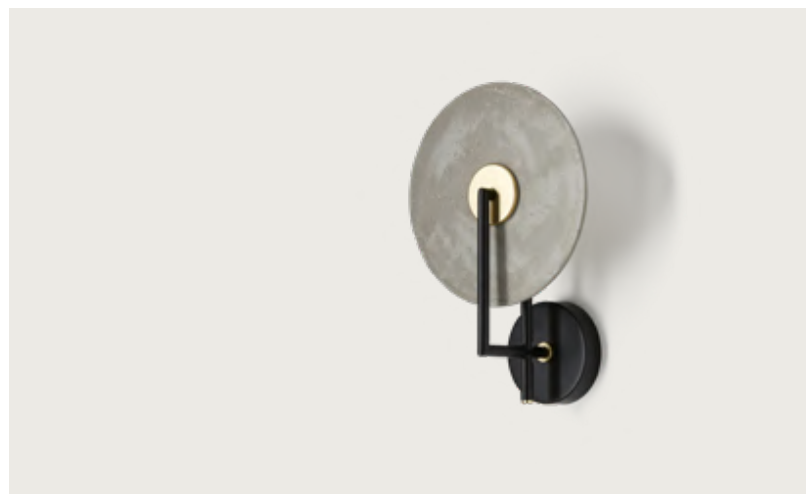

DESCRIPTION

MATERIALS

Steel

FINISHES

Metal:
Matt Black

Details:
Matt Brass

Image Accessory:
1097/20 - Ceramic Disc
Other options 355-356

Accessory included.

RECOMMENDED BULB
B005/5W

SPECIFICATIONS (UE)

G9 LED (Included)
5W - 2700K
220-240 V, 50/60 Hz
IP20, Class I

ENERGY LABEL

A ++



MATERIALES

Acero

ACABADOS

Metal:
Negro Mate

Detalles:
Oro mate

Accesorio Imagen:
1097/20 - Disco Cerámica
Otras opciones 355-356

Accesorio incluido.

BOMBILLA RECOMENDADA
B005/5W

ESPECIFICACIONES (UE)

G9 LED (Incluida)
5W - 2700K
220-240 V, 50/60 Hz
IP20, Clase I

ETIQUETA ENERGÉTICA

A ++

TECHNICAL

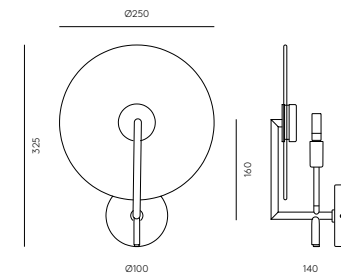

349

SUAL

Alabastro: 429€ (+IVA)
 Alabastro ondulado: 354€ (+IVA)
 Cerámica: 259€ (+IVA)
 Vidrio: 263€ (+IVA)
 Acero: 289€ (+IVA)

Wall lamp

A1255
 Designed by Fornasevi, 2020



DESCRIPTION

MATERIALS
 Steel / Acrylic

FINISHES

Metal:
 Matt black

Compatible Accessories

(Not included)
 Alabaster 1096/25 - 35
 Alabaster wave 1094/30
 Ceramic 1097/20 - 30
 Glass 1223
 Metal 1038/25-35

SPECIFICATIONS (UE)

Integrated LED plate 9W 3000K
 (Included) 24V / 220-240 V,
 50/60 Hz
 IP20, Class I

ENERGY LABEL

A ++



TECHNICAL

MATERIALES

Acero / Acrílico

ACABADOS

Metal:
 Negro mate

Accesorios compatibles:

(No incluidos)
 Alabastro 1096 / 25-35
 Alabastro ondulado 1094/30
 Cerámica 1097 / 20-30
 Cristal 1223
 Metal 1038/25-35

ESPECIFICACIONES (UE)

Placa LED integrada 9W 3000K
 (Incluido) 24V / 220-240 V,
 50/60 Hz
 IP20, Clase I

ETIQUETA ENERGÉTICA

A ++

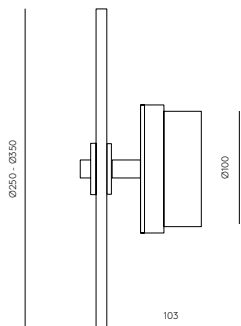

FLEXI LEATHER

265€ (+IVA)

Wall lamp

A1248
 Designed by AC Studio, 2018



DESCRIPTION

MATERIALS
 Steel / Leather

FINISHES

A1248
Metal:
 Matt Brass

Leather:
 Dark Brown

SPECIFICATIONS (UE)

LED integrated
 3W - 2700K
 12 V, 50/60 Hz
 IP20, Class I

ENERGY LABEL

A ++

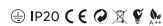

TECHNICAL

MATERIALES

Acero / Piel

ACABADOS

A1248
Metal:
 Oro mate

Leather:
 Marrón oscuro

ESPECIFICACIONES (UE)

LED integrado
 3W - 2700K
 12 V, 50/60 Hz
 IP20, Clase I

ETIQUETA ENERGÉTICA

A ++

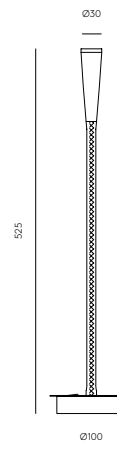

Monte Carlo, Monaco

MAHO 258€ (+IVA)

Wall lamp

A1254

Designed by JF Sevilla, 2018

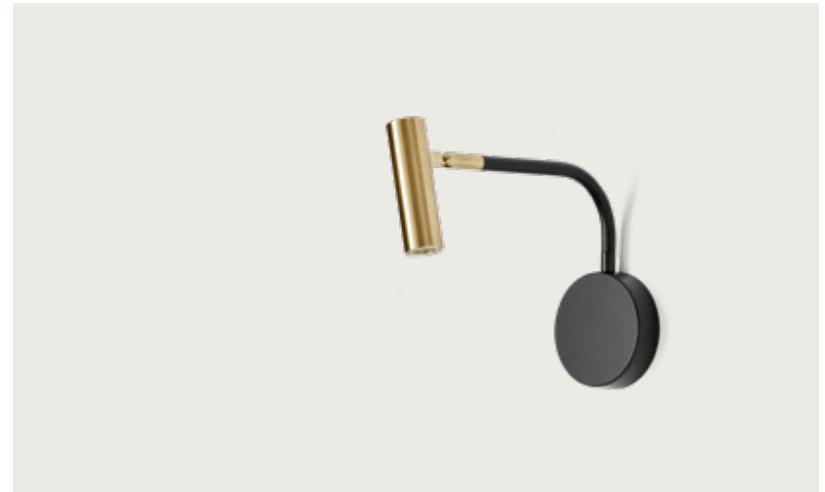

DESCRIPTION

MATERIALS
Steel

FINISHES
Body:
Matt Black
Head:
Matt Black
Matt Brass

SPECIFICATIONS (UE)
Integrated COB LED 5W 3000K
(Incluido) 220-240 V, 50/60 Hz
Touch Me - Dimmable
IP20, Class I

ENERGY LABEL
A++

Ⓜ IP20 CE Ⓢ Ⓡ Ⓡ Ⓡ Ⓡ Ⓡ Ⓡ

MATERIALES
Acero

ACABADOS
Cuerpo:
Negro Mate
Cabeza:
Negro Mate
Oro Mate

ESPECIFICACIONES (UE)
LED COB integrado 5W 3000K
(Incluido) 220-240 V, 50/60 Hz
Touch Me - Regulable
IP20, Clase I

ETIQUETA ENERGÉTICA
A++

TECHNICAL

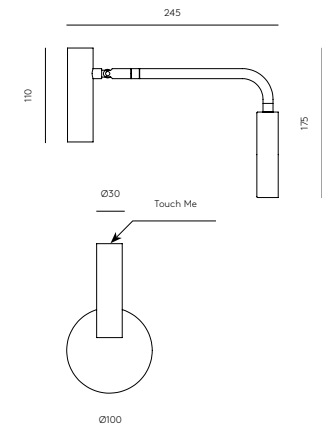

FICUS 315€ (+IVA)

Wall lamp

A1243

Designed by JF Sevilla, 2017



DESCRIPTION

MATERIALS

Steel

FINISHES

Metal:
Matt Brass

Shade:
Matt Black

SPECIFICATIONS (UE)

G9 (Included)
5W - 2700K
220-240 V, 50/60 Hz
IP20, Class I

ENERGY LABEL

A ++



MATERIALES

Acero

ACABADOS

Metal:
Oro mate

Tulipa:
Negro Mate

ESPECIFICACIONES (UE)

G9 (Incluida)
5W - 2700K
220-240 V, 50/60 Hz
IP20, Clase I

ETIQUETA ENERGÉTICA

A ++

TECHNICAL

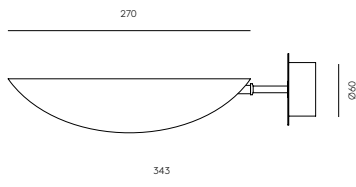

354

LUCA 221€ (+IVA)

Wall lamp

A1237

Designed by AC Studio, 2017

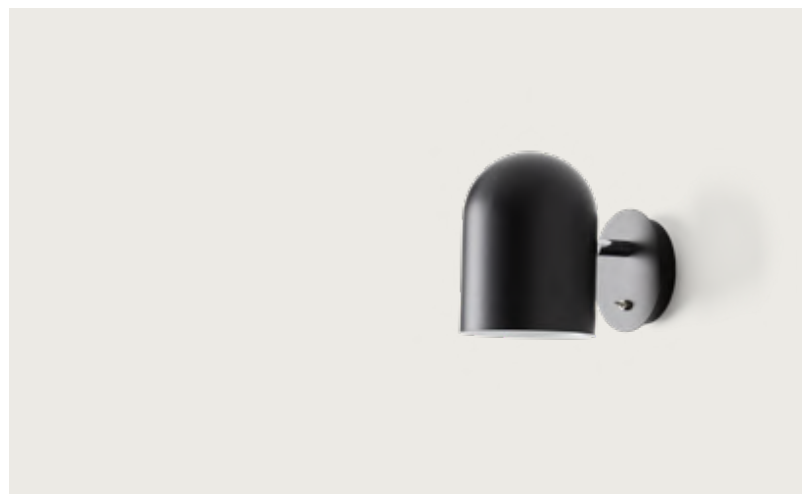

DESCRIPTION

MATERIALS

Steel

FINISHES

Metal:
Black

RECOMMENDED BULB

B211 (7, 9, 11W)

SPECIFICATIONS (UE)

E27 Max. 60W (Not included)
220-240 V, 50/60 Hz
IP20, Class I

ENERGY LABEL

A ++



MATERIALES

Acero

ACABADOS

Metal:
Negro

BOMBILLA RECOMENDADA

B211 (7, 9, 11W)

ESPECIFICACIONES (UE)

E27 Max. 60W (No incluida)
220-240 V, 50/60 Hz
IP20, Clase I

ETIQUETA ENERGÉTICA

A ++

TECHNICAL

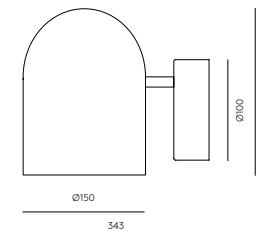

355

LITA 212€ (+IVA)

Wall lamp

A1230

Designed by Pepe Fornas, 2020

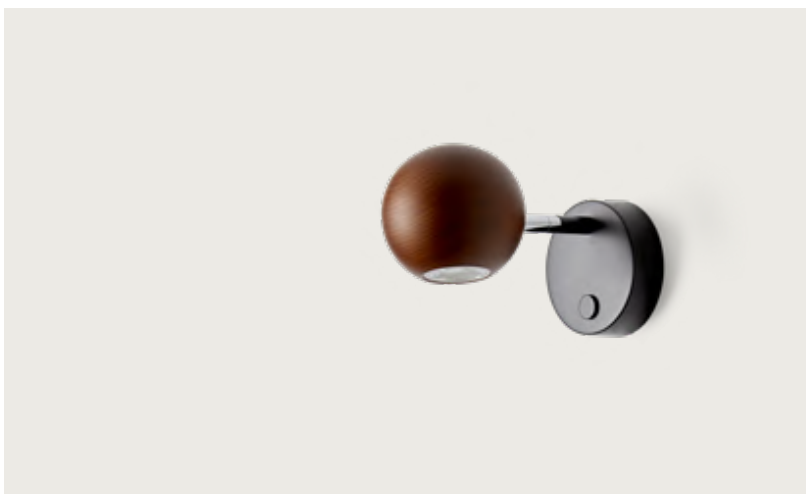

DESCRIPTION

MATERIALS

Steel / Walnut Wood

FINISHES

Metal:
Matt Black

Wood:
Matt black
Walnut

SPECIFICATIONS (UE)

LED COB integrated
3W 3000K (Incluida)
12V / 220-240 V, 50/60 Hz

ENERGY LABEL

A ++

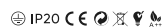

MATERIALES

Acero / Madera nogal

ACABADOS

Metal:
Negro Mate

Madera:
Negro Mate
Nogal

ESPECIFICACIONES (UE)

COB LED integrado
3W 3000K (Incluida)
12V / 220-240 V, 50/60 Hz

ETIQUETA ENERGÉTICA

A ++

TECHNICAL

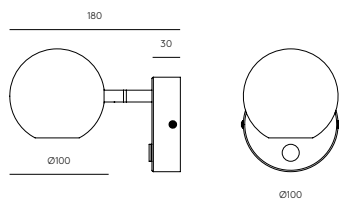

NERA 188€ (+IVA)

Wall lamp

A1229

Designed by Pepe Fornas, 2020

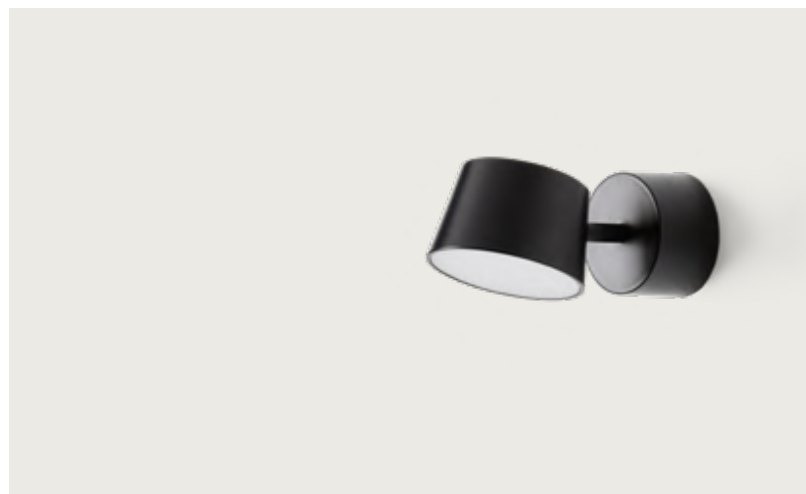

DESCRIPTION

MATERIALS

Steel / Acrylic

FINISHES

Metal:
Matt Black

SPECIFICATIONS (UE)

LED COB integrated 8W 3000K
(Incluida) Touch me dimmable
on the head
24V / 220-240 V, 50/60 Hz

ENERGY LABEL

A ++



MATERIALES

Acero / Acrílico

ACABADOS

Metal:
Negro Mate

ESPECIFICACIONES (UE)

COB LED integrado 8W 3000K
(Incluida) Touch me regulable en
la cabeza
24V / 220-240 V, 50/60 Hz

ETIQUETA ENERGÉTICA

A ++

TECHNICAL

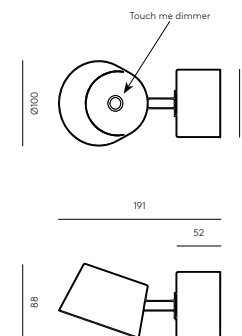



ALOA 350€ (+IVA)

Wall lamp

A1227

Designed by Fornasevi, 2017

DESCRIPTION

MATERIALS

Steel

FINISHES

Metal:
Matt Black

Difuser:
Shiny Gold

RECOMMENDED BULB

B038 / Gold

SPECIFICATIONS (UE)

E27 Max. 60W (Not included)
220-240 V, 50/60 Hz
IP20, Class II

ENERGY LABEL

A ++

IP20 CE X RoHS A++

MATERIALES

Acero

ACABADOS

Metal:
Negro Mate

Difusor interior:
Oro Brillo

BOMBILLA RECOMENDADA

B038 / Oro

ESPECIFICACIONES (UE)

E27 Max. 60W (No incluida)
220-240 V, 50/60 Hz
IP20, Clase II

ETIQUETA ENERGÉTICA

A ++

TECHNICAL

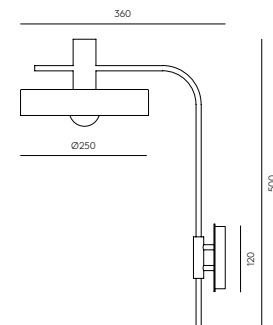

359



DELIE Negro Mate, Mármol blanco: 261€ (+IVA)
Oro Envejecido, Mármol negro: 270€ (+IVA)

Wall lamp

A1224
Designed by JF Sevilla, 2020

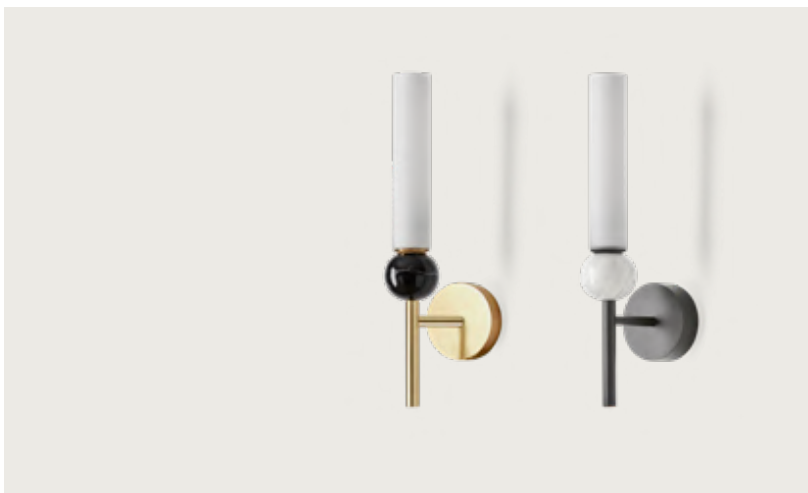

DESCRIPTION

MATERIALS
Steel / Blown Glass / Marble

FINISHES
Metal: Matt Black, Aged Gold
Marble: White, Black

Glass: Opal

RECOMMENDED BULB
B005/5W

SPECIFICATIONS (UE)
G9 LED 5W 2700K (Included)
220-240 V, 50/60 Hz
IP20, Class II

ENERGY LABEL
A ++



TECHNICAL

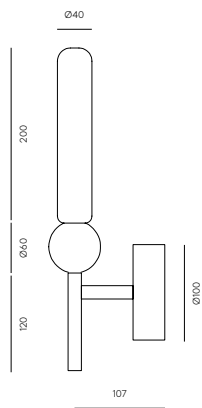

DELIE · L Negro Mate, Mármol blanco: 361€ (+IVA)
Oro Envejecido, Mármol negro: 385€ (+IVA)

Wall lamp

A1224/L
Designed by JF Sevilla, 2020

DESCRIPTION

MATERIALS
Steel / Blown Glass / Marble

FINISHES
Metal: Matt Black, Aged Gold
Marble: White, Black
Glass: Opal

RECOMMENDED BULB
B005/5W

SPECIFICATIONS (UE)
G9 LED 5W 2700K (Included)
220-240 V, 50/60 Hz
IP20, Class II

ENERGY LABEL
A ++

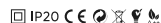

MATERIALES
Acero / Vidrio Soplado / Mármol

ACABADOS
Metal: Negro Mate, Oro Envejecido
Mármol: Blanco, Negro
Cristal: Opal

BOMBILLA RECOMENDADA
B005/5W

ESPECIFICACIONES (UE)
G9 LED 5W 2700K (Incluida) 220-
240 V, 50/60 Hz
IP20, Clase II

ETIQUETA ENERGÉTICA
A ++

TECHNICAL

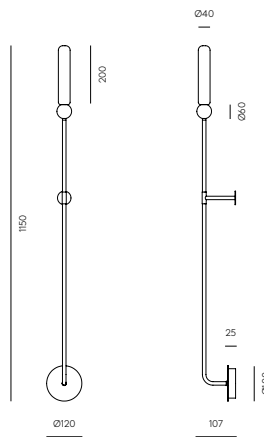

HELMET 265€ (+IVA)

Wall lamp

A1221

Designed by Pepe Fornas, 2016

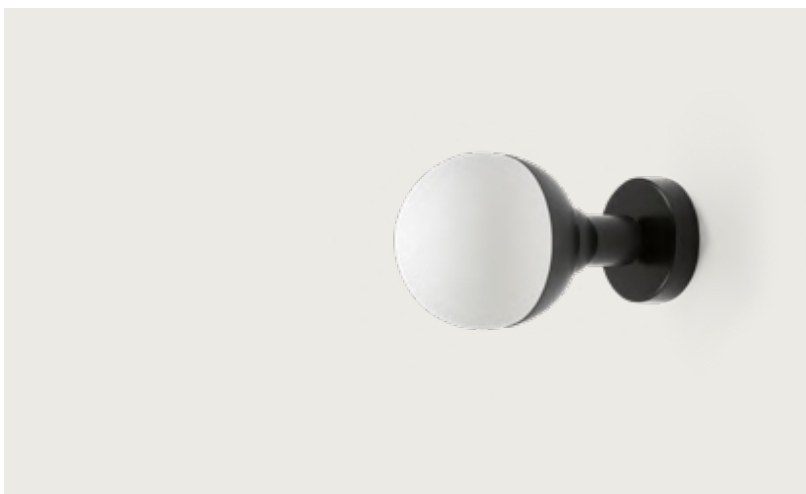

DESCRIPTION

MATERIALS
Steel / Blown Glass

FINISHES

Metal:
Shiny Gold
Matt Brass
Matt Black
Chrome

BULB INCLUDED
B033/COB
B034/COB

SPECIFICATIONS (UE)
E27 2700K - 270 lm
(Bulb included)
220-240 V, 50/60 Hz
IP20, Class I

ENERGY LABEL
A ++



TECHNICAL

MATERIALES
Acero / Vidrio Soplado

ACABADOS

Metal:
Oro (Brillo o Mate)
Negro Mate
Cromo

BOMBILLA INCLUIDA
B033/COB
B034/COB

ESPECIFICACIONES (UE)
E27 2700K - 270 lm
(Bombilla incluida)
220-240 V, 50/60 Hz
IP20, Clase I

ETIQUETA ENERGÉTICA
A ++

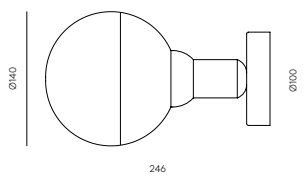

362

HELMET CURVE 496€ (+IVA)

*Preguntar por disponibilidad

Wall lamp

A1219

Designed by Pepe Fornas, 2016

DESCRIPTION

MATERIALS
Steel / Blown Glass

FINISHES

Metal:
Matt Brass
Matt Black

BULB INCLUDED
B033/COB
B034/COB

SPECIFICATIONS (UE)
E27 - B033/COB included (opal)
3W - 3000K
220-240 V, 50/60 Hz
IP20, Class I

ENERGY LABEL
A ++



MATERIALES
Acero / Vidrio Soplado

ACABADOS

Metal:
Oro Mate
Negro Mate

BOMBILLA INCLUIDA
B033/COB
B034/COB

ESPECIFICACIONES (UE)
E27 - B033/COB incluida (opal)
3W - 3000K
220-240 V, 50/60 Hz
IP20, Clase I

ETIQUETA ENERGÉTICA
A ++

TECHNICAL

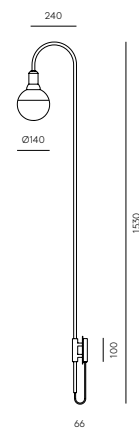

363



LIND 242€ (+IVA)

Wall lamp

A1220

Designed by Agus Gascón, 2016

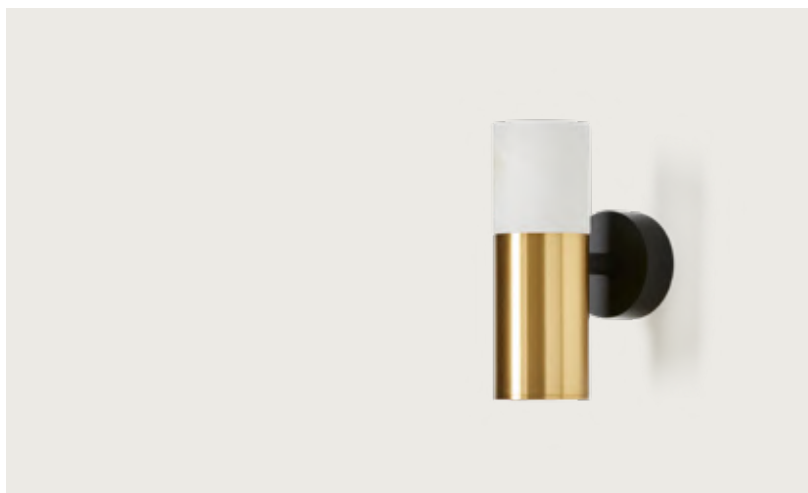

DESCRIPTION

MATERIALS

Steel / Alabaster

FINISHES

Metal:
Matt Brass
Matt Black

Shade:
Alabaster

RECOMMENDED BULB
B005/5W

SPECIFICATIONS (UE)

G9 (Included)
5W - 2700K
220-240 V, 50/60 Hz
IP20, Class I

ENERGY LABEL

A ++



TECHNICAL

MATERIALES

Acero / Alabastro

ACABADOS

Metal:
Oro Mate
Negro Mate

Tulipa:
Alabastro

BOMBILLA RECOMENDADA
B005/5W

ESPECIFICACIONES (UE)

G9 (Incluida)
5W - 2700K
220-240 V, 50/60 Hz
IP20, Clase I

ETIQUETA ENERGÉTICA

A ++

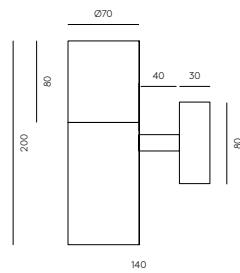

ATOM 331€ (+IVA)

Wall lamp

A1214

Designed by AC Studio, 2016

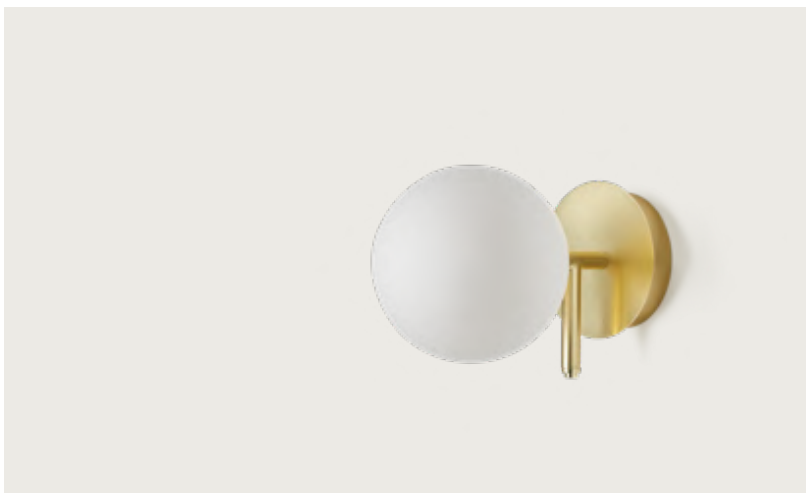

DESCRIPTION

MATERIALS

Steel / Blown Glass

FINISHES

Metal:
Matt Black
Matt Brass

Shade (Included):
Opal
Clear

INCLUDED BULB
B005/5W

SPECIFICATIONS (UE)

Bulb G9 (Included)
5W - 2700K
220-240 V, 50/60 Hz
IP20, Class I

ENERGY LABEL

A ++

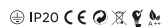

MATERIALES

Acero / Vidrio Soplado

ACABADOS

Metal:
Negro Mate
Oro Mate

Cristal (Incluido):
Opal
Transparente

BOMBILLA INCLUIDA
B005/5W

ESPECIFICACIONES (UE)

Bombilla G9 (Incluida)
5W - 2700K
220-240 V, 50/60 Hz
IP20, Clase I

ETIQUETA ENERGÉTICA

A ++

TECHNICAL

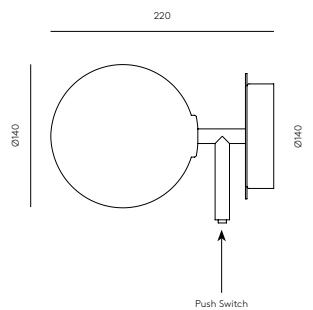

DOBI 300€ (+IVA)

Wall lamp

A1207

Designed by AC Studio, 2015



DESCRIPTION

MATERIALS

Steel

FINISHES

Metal:
Matt Black
Matt White

RECOMMENDED BULB
B116-2 / 5W

SPECIFICATIONS (UE)

E14 Max. 40W (Not included)
220-240 V, 50/60 Hz
IP20, Class I

ENERGY LABEL

A ++

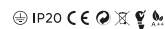

MATERIALES

Acero

ACABADOS

Metal:
Negro Mate
Blanco Mate

BOMBILLA RECOMENDADA
B116-2 / 5W

ESPECIFICACIONES (UE)

E14 Max. 40W (No incluida)
220-240 V, 50/60 Hz
IP20, Clase I

ETIQUETA ENERGÉTICA

A ++

TECHNICAL

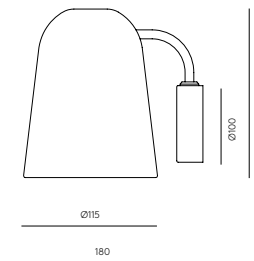

BIGCOSS 928€ (+IVA)

A1203/80

Designed by Ac Studio, 2023

DESCRIPTION

MATERIALS

Metal / Acrylic / Crystal

FINISHES

Body:

Matt Black

Diffuser:

Mirror

SPECIFICATIONS

25W 2700K LED strip

Touch me dimmable

24V, 50/60Hz

IP20, Class I

ENERGY LABEL

A ++

MATERIALES

Metal / Acrílico / Cristal

ACABADOS

Cuerpo:

Negro Mate

Difusor:

Espejo

ESPECIFICACIONES

Tira LED 25W 2700K

Touch me regulable

24 V, 50/60 Hz

IP20, Clase I

ETIQUETA ENERGÉTICA

A ++

IP20 CE RoHS REACH A++

TECHNICAL

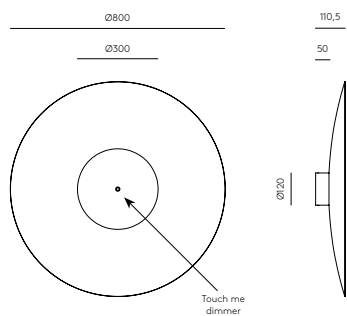

370

Valetta, Malta



MARU 338€ (+IVA)

Wall lamp

A1194

Designed by JF Sevilla, 2015

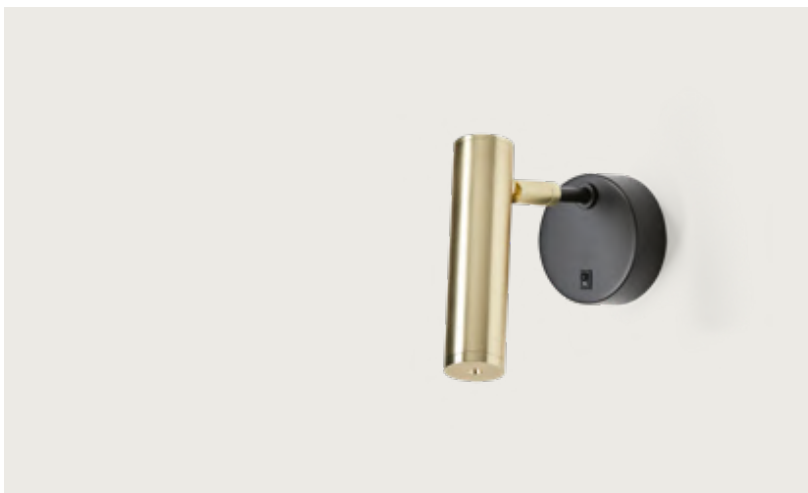

DESCRIPTION

MATERIALS

Steel

FINISHES

Canopy:
Matt Black

Head:
Matt Brass
Matt Black

SPECIFICATIONS (UE)

Chip Led Integrated
3W - 3150K
12 V, 50/60 Hz
IP20, Class I

ENERGY LABEL

A ++

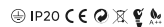

MATERIALES

Acero

ACABADOS

Florón:
Negro Mate

Cabeza:
Oro Mate
Negro Mate

ESPECIFICACIONES (UE)

Chip Led integrado
3W - 3150K
12 V, 50/60 Hz
IP20, Clase I

ETIQUETA ENERGÉTICA

A ++

TECHNICAL

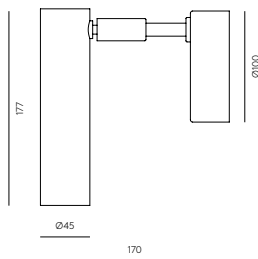

372

LOTTO 15cm: 219€ (+IVA) 20cm: 258€ (+IVA) 25cm: 277€ (+IVA)

Wall lamp

A1176 / A1175 / A1174

Designed by AC Studio, 2014



DESCRIPTION

MATERIALS

Steel / Glass

FINISHES

Metal:
Shiny Gold
Chrome
White
Black
Glass:
Clear

SIZES

A1176 - Ø250 X 150
A1175 - Ø200 X 120
A1174 - Ø150 X 100

LED DIFFUSER OPTION

A1176/LED:
LED 9W 3000K

SPECIFICATIONS (UE)

Bulb Led included - B030
2W - 2700K
IP20, Class I

ENERGY LABEL

A ++

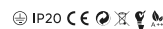

MATERIALES

Acero / Cristal

ACABADOS

Metal:
Oro Brillo
Cromo
Blanco
Negro
Cristal:
Transparente

MEDIDAS

A1176 - Ø250 X 150
A1175 - Ø200 X 120
A1174 - Ø150 X 100

OPCIÓN DIFUSOR LED

A1176/LED:
LED 9W 3000K

ESPECIFICACIONES (UE)

Bombilla Led incluida - B030
2W - 2700K
IP20, Clase I

ETIQUETA ENERGÉTICA

A ++

TECHNICAL

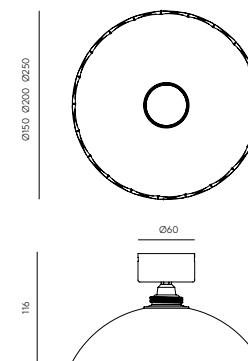

373



DUO 732€ (+IVA)

Wall lamp

A1170/2
Designed by AC Studio, 2021

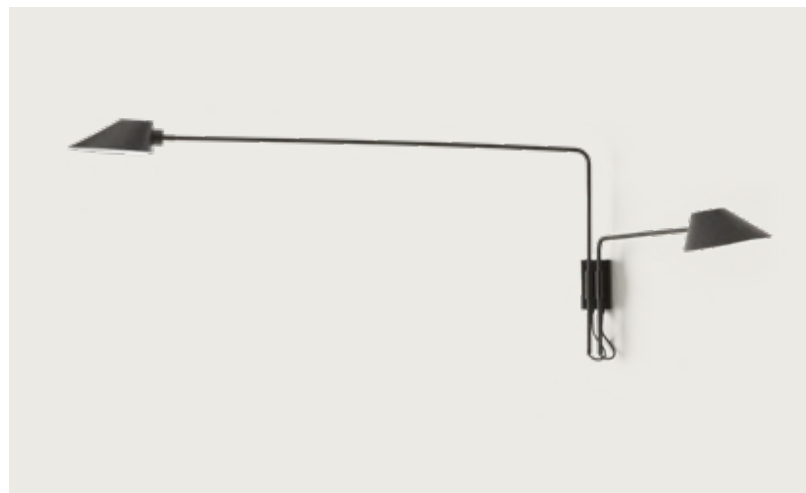

DESCRIPTION

MATERIALS

Steel

FINISHES

Body:
Matt Black
Tulip:
Matt black outside
Matt white inside

SPECIFICATIONS (UE)
2x E27 max. 60W LED (no included) 230V, 50/60 Hz, IP20, Class I

ENERGY LABEL

A ++



MATERIALES

Acero

ACABADOS

Cuerpo:
Negro Mate
Tulipa:
Negro mate exterior
Blanco mate interior

ESPECIFICACIONES (UE)
2 x E27 max. 60W LED (no incluida) 230V, 50/60 Hz, IP20, Clase I

ETIQUETA ENERGÉTICA

A ++

TECHNICAL

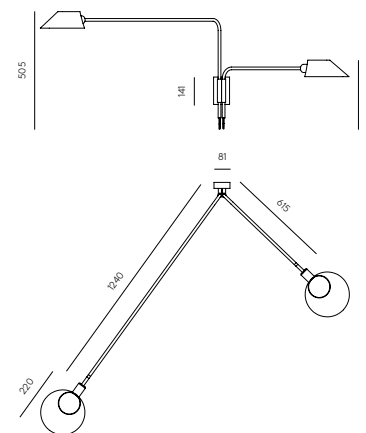

CALP 242€ (+IVA)

A1168

Designed by AC Studio, 2022

DESCRIPTION

MATERIALS

Ceramics

FINISHES

Ceramics:

Hand painted

See colour palette

Image colour: Nude

SPECIFICATIONS (UE)

G9 Led Bulbs 5W - 3000K

(Included)

220-240V, 50/60Hz

IP20, Class I

ENERGY LABEL

A ++

IP20 CE RoHS WEEE

MATERIALES

Cerámica

ACABADOS

Cerámica:

Pintado a mano

Consultar paleta de colores

Color en imagen: Nude

ESPECIFICACIONES (UE)

G9 Bombillas Led 5W - 3000K

(Incluida)

220-240 V, 50/60 Hz

IP20, Clase I

ETIQUETA ENERGÉTICA

A ++

TECHNICAL

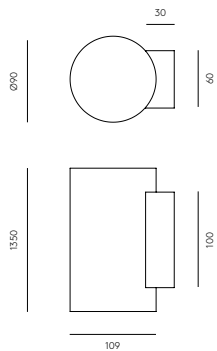

IBRE 30cm: 399€ (+IVA)
50cm: 482€ (+IVA)

Wall lamp

A1162
Designed by AC Studio, 2021

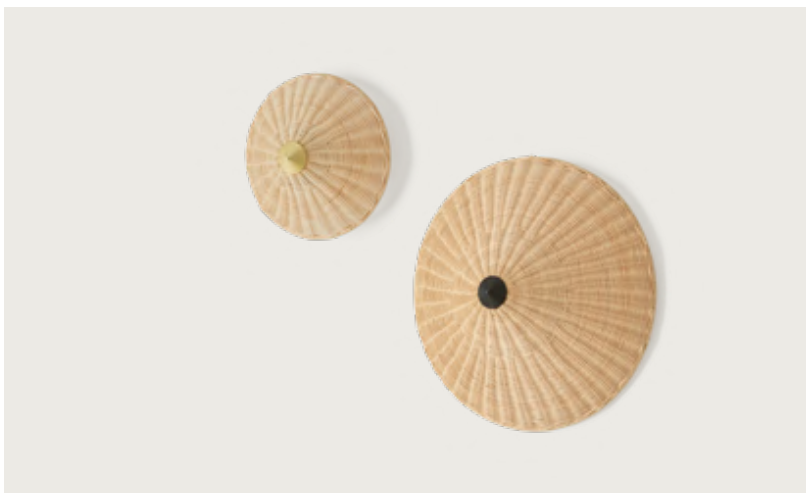

DESCRIPTION

MATERIALS
Steel / Wicker

FINISHES
Metal:
Matt Gold
Matt Black

Shade:
Natural Wicker

SPECIFICATIONS (UE)
A1163/30:
COB LED 9W- 2700K
TRIAC dimmable - IP20, Class I
220-240V - 24V, 50/60 Hz

A1120/22
COB LED 9W- 3000K
Dimmable - IP20, Class I
220-240V - 24V, 50/60 Hz

ENERGY LABEL
A ++
IP20 CE RoHS WEEE A++

MATERIALES
Acero / Mimbre

ACABADOS
Metal:
Oro mate
Negro Mate

Pantalla:
Mimbre natural

ESPECIFICACIONES (UE)
A1163/30:
Placa LED 9W- 2700K
Regulable TRIAC - IP20, Clase I
220-240V - 24V, 50/60 Hz

A1120/22
Placa LED 9W- 3000K
Regulable - IP20, Clase I
220-240V - 24V, 50/60 Hz

ETIQUETA ENERGÉTICA
A ++

TECHNICAL

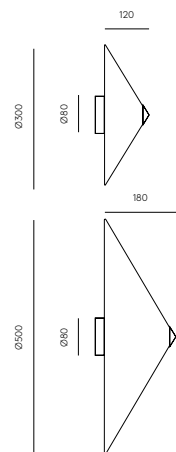

VENT 216€ (+IVA)

Wall lamp

A1161
Designed by Pepe Fornas, 2020

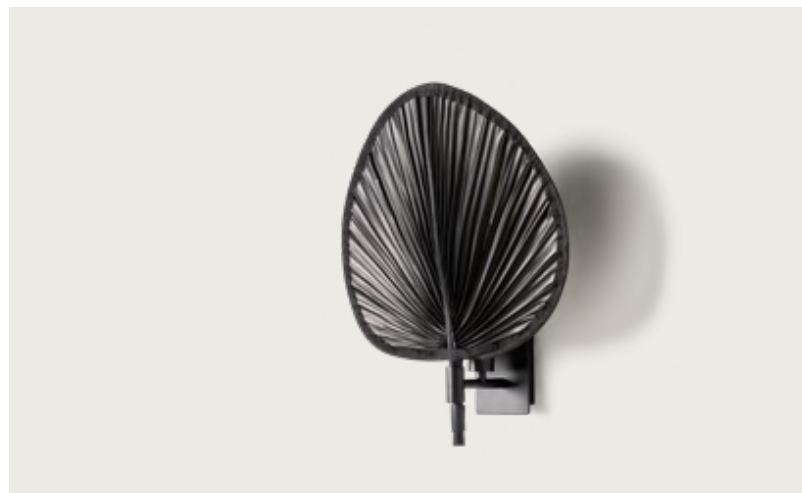

DESCRIPTION

MATERIALS
Steel / Palm leaf

FINISHES
Metal:
Black

Pai Pai Leaf:
Black - Black Ribon
Natural - Black Ribon

SPECIFICATIONS (UE)
G9 LED 5W 2700K (Included)
220-240 V, 50/60 Hz

ENERGY LABEL
A ++
IP20 CE RoHS WEEE A++

MATERIALES
Acero / Hoja de Palma

ACABADOS
Metal:
Negro Mate

Hoja Pai Pai:
Natural / Ribete Negro
Negro / Ribete Negro

ESPECIFICACIONES (UE)
G9 LED 5W 2700K (Incluida) 220-
240 V, 50/60 Hz

ETIQUETA ENERGÉTICA
A ++

TECHNICAL

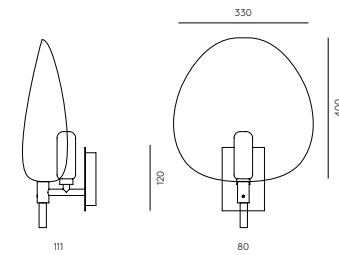

FLEXOR 189€ (+IVA)

Wall lamp

A1151

Designed by AC Studio, 2009



DESCRIPTION

MATERIALS

Steel / Silicon

FINISHES

Metal:
Matt White
Matt Black

SPECIFICATIONS (UE)

3W LED (Included)
3000K, 12 V, 50/60 Hz
IP20, Class I

ENERGY LABEL

A ++

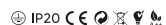

MATERIALES

Acero / Silicona

ACABADOS

Metal:
Blanco Mate
Negro Mate

ESPECIFICACIONES (UE)

3W LED (Incluido)
3000K, 12 V, 50/60 Hz
IP20, Clase I

ETIQUETA ENERGÉTICA

A ++

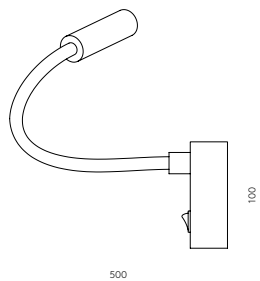

TECHNICAL

380

PILD 280€ (+IVA)

Wall lamp

A1149

Designed by Pepe Fornas, 2019

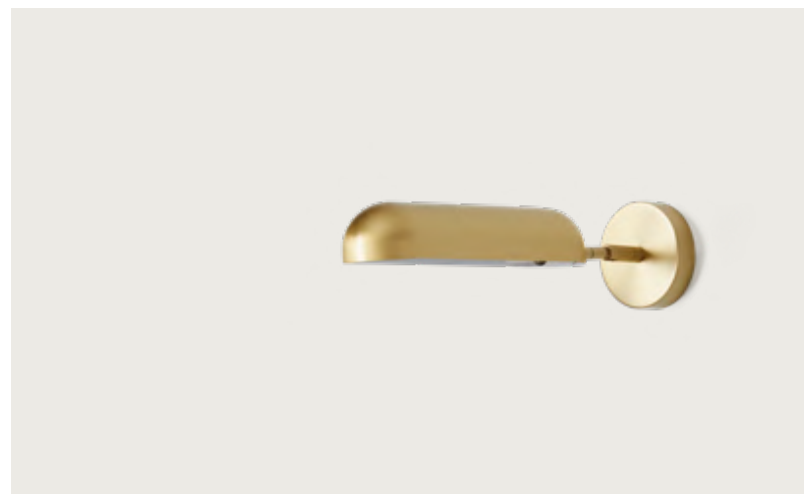

DESCRIPTION

MATERIALS

Steel

FINISHES

Metal:
Matt Brass
Matt Black

Inside white

RECOMMENDED BULB

B005

SPECIFICATIONS (UE)

Bulb G9 (NOT included)
5W - 2700K
220-240 V, 50/60 Hz
IP20, Class I

ENERGY LABEL

A ++



MATERIALES

Acero

ACABADOS

Metal:
Oro Mate
Negro Mate

Interior blanco

BOMBILLA RECOMENDADA

B005

ESPECIFICACIONES (UE)

Bombilla G9 LED (NO Incluido)
5W - 2700K
220-240 V, 50/60 Hz
IP20, Clase I

ETIQUETA ENERGÉTICA

A ++

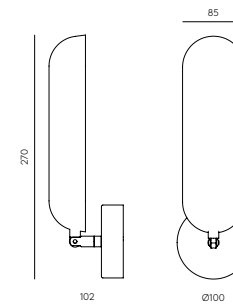

381

Lecce, Italy



AORA 242€ (+IVA)

Wall lamp

A1129

Designed by AC Studio, 2023



DESCRIPTION

MATERIALS

Steel / Ceramics

FINISHES

Metal:
Shiny gold
Chrome
White
Black

Ceramics:
Hand painted
See colour palette

Image colours:

Left: Nude
Right: Vintage brown

SPECIFICATIONS (UE)

Direct LED plate 7W 3000K
220-240V, 50/60Hz
IP20, Class I

ENERGY LABEL

A ++

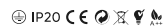

TECHNICAL

MATERIALES

Acero / Cerámica

ACABADOS

Metal:
Oro Brillo
Cromo
Blanco
Negro

Cerámica:
Pintada a mano
Consultar paleta de colores

Colores en imagen:

Izda. Nude
Dcha. Marrón vintage

ESPECIFICACIONES (UE)

Placa LED directa 7W 3000K
220-240 V, 50/60 Hz
IP20, Clase I

ETIQUETA ENERGÉTICA

A ++

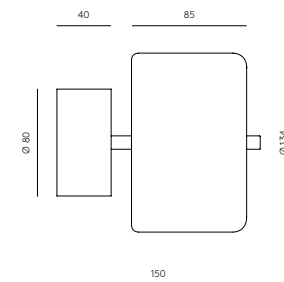

OSION 424€ (+IVA)

Wall lamp

A1132
Designed by JF Sevilla, 2019

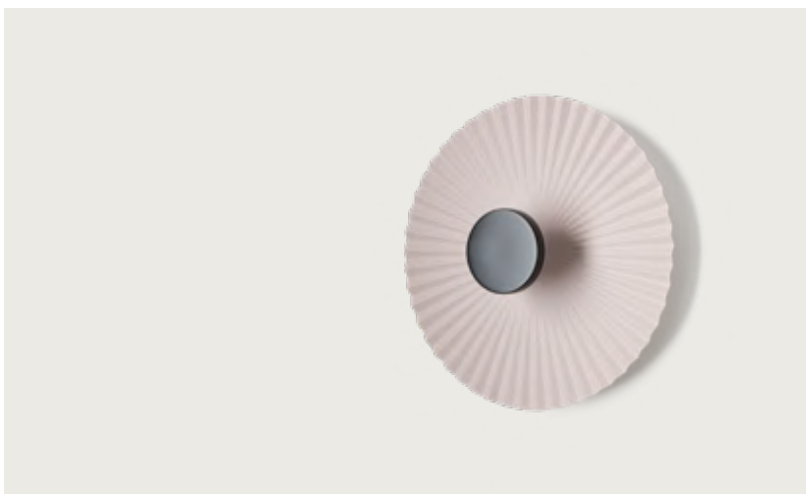

DESCRIPTION

MATERIALS

Steel / Resin

FINISHES

Metal:
Matt Brass
Black

Resin:
White

Image colour:
Pale pink
Hand painted

MODIFICACIONES POSIBLES

Check colour palette
Option to have it with E27

SPECIFICATIONS (UE)

LED integrated
TRIAC Dimmable
9W - 2700K
12V, 50/60Hz
IP20, Class I

ENERGY LABEL

A ++



MATERIALES

Acero / Resina

ACABADOS

Metal:
Oro Mate
Negro

Resina:
Blanca

Image colour:
Rosa palo
Pintada a mano

MODIFICACIONES POSIBLES

Consulta la paleta de colores
Opción de portalámparas E27

ESPECIFICACIONES (UE)

LED integrado
Regulador TRIAC
9W - 2700K
12V, 50/60Hz
IP20, Clase I

ETIQUETA ENERGÉTICA

A ++

TECHNICAL

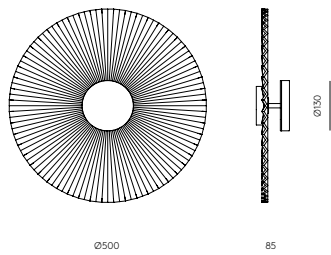

ALTUN 15cm: 245€ (+IVA) 22cm: 303€ (+IVA)

Wall lamp

A1120
Designed by Pepe Fornas, 2021

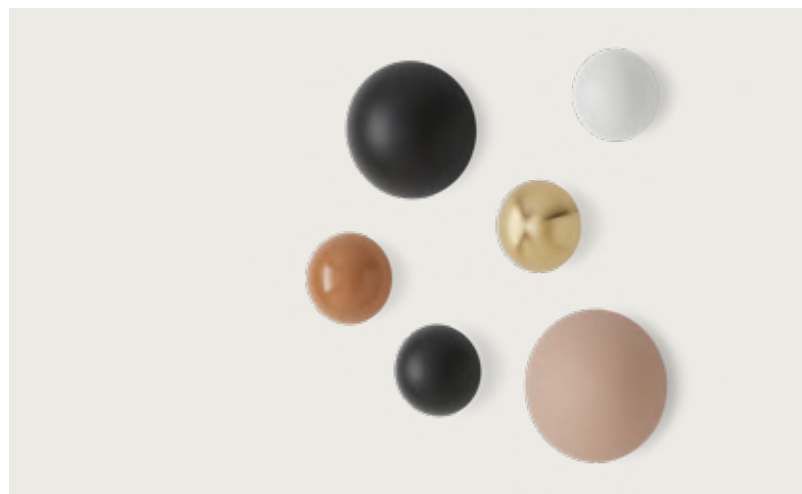

DESCRIPTION

MATERIALS

Steel

FINISHES

Canopy:
Matt White

Diffuser:
Matt Black
Matt white
Matt Gold

Other colors on page.432

SPECIFICATIONS (UE)

A1120/15
COB LED 9W-2700K
TRIAC Dimmable - IP20, Class I
220-240V - 24V, 50/60 Hz

A1120/22
COB LED 12W- 3000K
Dimmable - IP20, Class I
220-240V - 24V, 50/60 Hz

ENERGY LABEL

A ++



MATERIALES

Acero

ACABADOS

Florón:
Blanca mate

Diffusor:
Oro Mate
Negro Mate
Blanco mate

Otros colores en pág.432

ESPECIFICACIONES (UE)

A1120/15
Placa LED 9W- 2700K
Regulable TRIAC- IP20, Clase I
220-240V - 24V, 50/60 Hz

A1120/22
Placa LED 12W- 3000K
Regulable - IP20, Clase I
220-240V - 24V, 50/60 Hz

ETIQUETA ENERGÉTICA

A ++

TECHNICAL

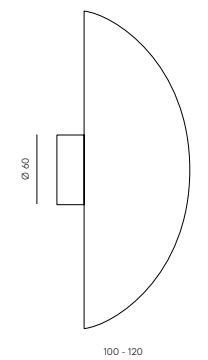

FIND 175€ (+IVA)

Wall lamp

A1110

Designed by AC Studio, 2010

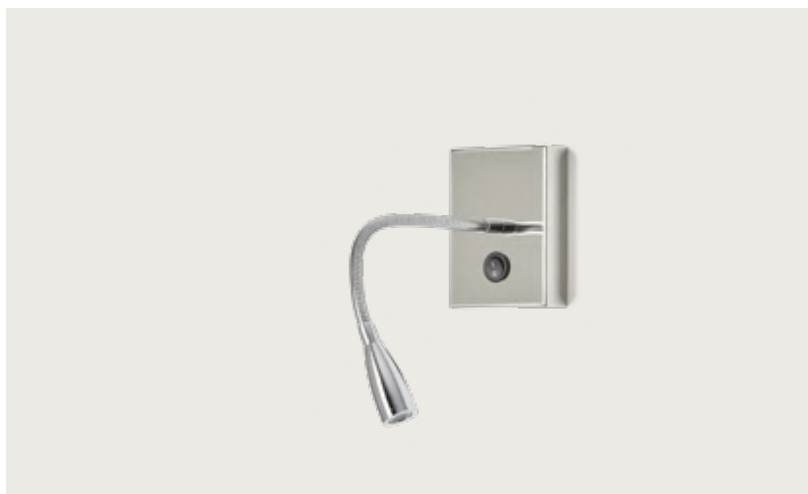

DESCRIPTION

MATERIALS

Steel / Fabric

FINISHES

Metal:
Chrome

RECOMMENDED BULB

B211 (7, 9, 11W)

SPECIFICATIONS (UE)

LED 3W - 3000K
12V, 50/60 Hz
IP20, Class I

ENERGY LABEL

A ++



TECHNICAL

MATERIALES

Acero / Pantalla Textil

ACABADOS

Metal:
Cromo

BOMBILLA RECOMENDADA

B211 (7, 9, 11W)

ESPECIFICACIONES (UE)

LED 3W - 3000K
12V, 50/60 Hz
IP20, Clase I

ETIQUETA ENERGÉTICA

A ++

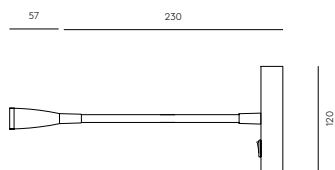

READ 231€ (+IVA)

Wall lamp

A1106

Designed by AC Studio, 2009



DESCRIPTION

MATERIALS

Steel / Fabric

FINISHES

Metal:
Chrome
Fabric:
White

SHADE INCLUDED

RECOMMENDED BULB
B211 (7, 9, 11W)

SPECIFICATIONS (UE)

E27 Max. 60W (Not included)
220-240 V, 50/60 Hz
IP20, Class I
Led 3W - 3000K - 270 lm (Incl)
12 V, 50/60 Hz, IP20, Class I

ENERGY LABEL

A ++

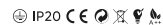

TECHNICAL

MATERIALES

Acero

ACABADOS

Metal:
Cromo
Textil:
Blanco

PANTALLA INCLUIDA

RECOMMENDED BULB
B211 (7, 9, 11W)

ESPECIFICACIONES (UE)

E27 Max. 60W (No incluido)
220-240 V, 50/60 Hz, IP20,
Clase I
Led 3W - 3000K - 270 lm (Incl)
12 V, 50/60 Hz, IP20, Clase I

ETIQUETA ENERGÉTICA

A ++

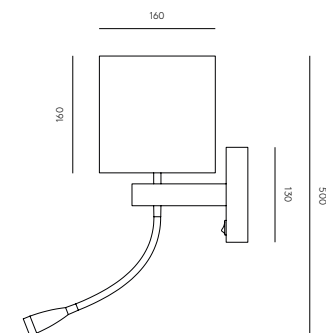

CROPI 25cm: 380€ (+IVA)
56cm: 447€ (+IVA)

A1100/56 - A1100/25
Designed by Pepe Fornas, 2017

DESCRIPTION

MATERIALS

Steel

FINISHES

Metal:
Aged Gold
Black

MEASUREMENTS

Diameter 250 mm
Diameter 560 mm

Colors in image:
A1100/56 Terracotta
A1100/25 Black

SPECIFICATIONS (UE)

E27 60 W Max (Not Included)
220-240 V, 50/60 Hz,
Ip20, Class I

ENERGY LABEL

A ++

⊕ IP20 CE   

MATERIALES

Acero

ACABADOS

Metal:
Oro Envejecido
Negro

MEDIDAS

Diámetro 250 mm
Diámetro 560 mm

Colores en imagen:
A1100/56 Terracotta
A1100/25 Negro

ESPECIFICACIONES (UE)

E27 60 W Max (No Incluida)
220-240 V, 50/60 Hz,
Ip20, Clase I

ETIQUETA ENERGÉTICA

A ++

TECHNICAL

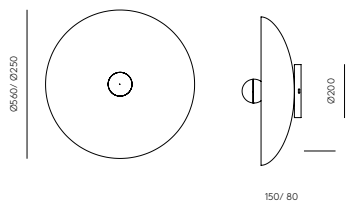



RANG 412€ (+IVA)

Wall lamp

A1093

Designed by JF Sevilla, 2022

DESCRIPTION

MATERIALS

Steel / Resin

FINISHES

Steel:

Matte Brass

Chrome

Resin:

White

Check colour palette

SPECIFICATIONS (UE)

Integrated led

9W - 2700K

TRIAC Dimmable

12V, 50/60Hz

IP20, Class I

ENERGY LABEL

A ++

MATERIALES

Acero / Resina

ACABADOS

Acero:

Latón Mate

Cromo

Resina:

Blanco

Consulta paleta de colores

ESPECIFICACIONES (UE)

Led integrado

9W - 2700K

Regulable TRIAC

12V, 50/60Hz

IP20, Clase I

ETIQUETA ENERGÉTICA

A ++

IP20 CE RoHS REACH

TECHNICAL

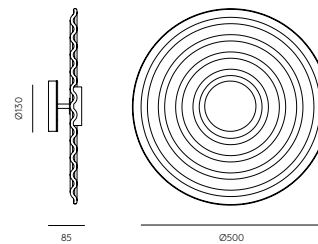

VASTER 303€ (+IVA)

Wall lamp

A1092
Designed by Pepe Fornas, 2017



DESCRIPTION

MATERIALS
Steel / Alabaster

FINISHES
Metal:
Chrome

RECOMMENDED BULB
B005

SPECIFICATIONS (UE)
Bulb G9 5W 2700K (Incluida)
TRIAC Dimmable
220-240 V, 50/60 Hz
IP20, Class I

ENERGY LABEL
A ++



MATERIALES
Acero / Alabastro

ACABADOS
Metal:
Cromo

BOMBILLA RECOMENDADA
B005

ESPECIFICACIONES (UE)
Bombilla G9 5W 2700K (Incluida)
TRIAC Regulable
220-240 V, 50/60 Hz
IP20, Clase I

ETIQUETA ENERGÉTICA
A ++

TECHNICAL

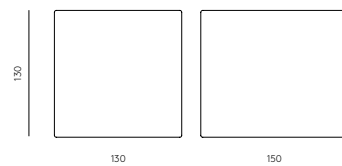

MINI ROSS 25cm: 207€ (+IVA) 40cm: 342€ (+IVA)

Wall lamp

A1063
Designed by JF Sevilla, 2015

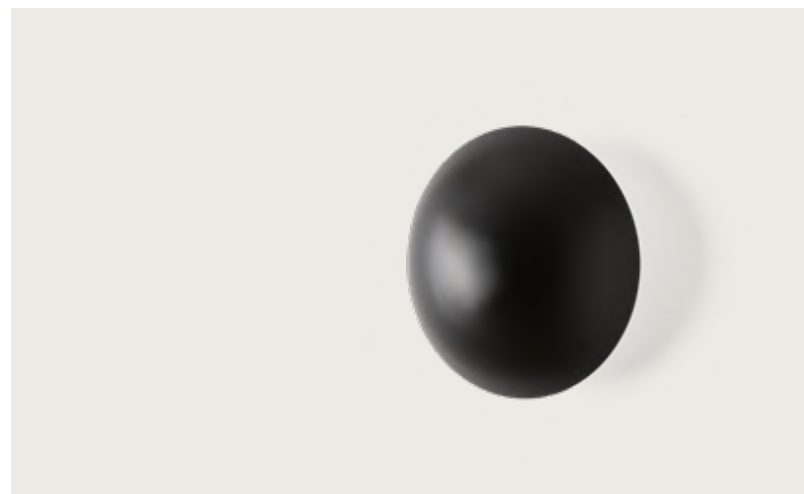

DESCRIPTION

MATERIALS
Steel

FINISHES
Metal:
Shinny Gold
Matt Gold
Chrome
Matt Black

AVAILABLE SIZES
A1063/40 - 40CM
A1063/25 - 25 CM

RECOMMENDED BULB
B005

SPECIFICATIONS (UE)
3 x G9 LED Bulb (Included)
3W - 2700K
TRIAC Dimmable
220-240 V, 50/60 Hz
IP20, Class I

ENERGY LABEL
A ++

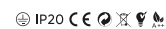

MATERIALES
Acero

ACABADOS
Metal:
Oro Brillo
Oro Mate
Cromo
Negro Mate

MEDIDAS DISPONIBLES
A1063/40 - 40CM
A1063/25 - 25 CM

BOMBILLA RECOMENDADA
B005

ESPECIFICACIONES (UE)
3 x Bombilla G9 Led (Incluida)
3W - 2700K
TRIAC Regulable
220-240 V, 50/60 Hz
IP20, Clase I

ETIQUETA ENERGÉTICA
A ++

TECHNICAL

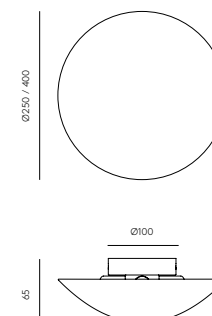

LASS 30cm: 245€ (+IVA)
50cm: 286€ (+IVA)

Wall lamp

A1053 + 1225

Designed by Fornasevi, 2022

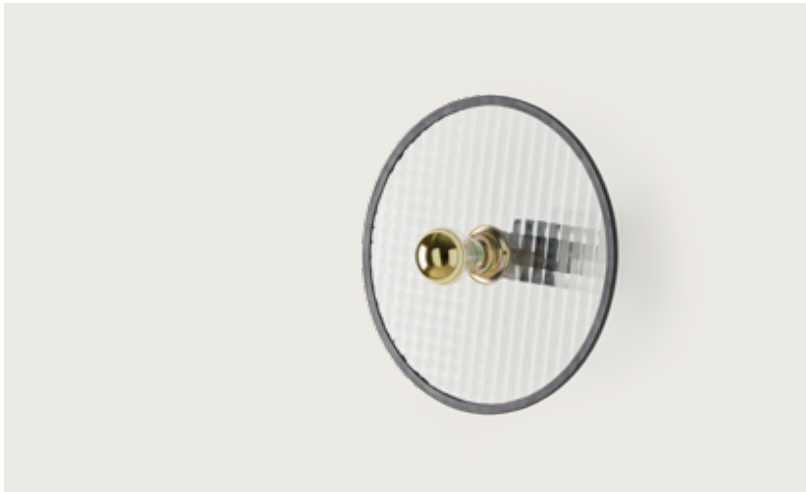

DESCRIPTION

MATERIALS
Steel / Textured glass

FINISHES

Steel:
Bright Gold
Chrome
White
Black

SPECIFICATIONS (UE)

E27 Max. 60W
(Not included)
220-240V, 50/60Hz
IP20, Class I

ENERGY LABEL

A ++

⊕ IP20 CE RoHS REACH

TECHNICAL

MATERIALES

Acero / Cristal texturizado

ACABADOS

Acero:
Oro Brillo
Cromo
Blanco
Negro

ESPECIFICACIONES (UE)

E27 Max. 60W
(No incluida)
220-240 V, 50/60 Hz
IP20, Clase I

ETIQUETA ENERGÉTICA

A ++

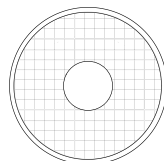

300 - 500

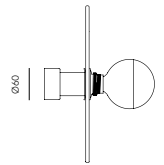

50 100 150 200 250

Bucharest, Romania



FEST 233€ (+IVA)

Wall lamp

A1053 + 1223

Designed by JF Sevilla, 2016

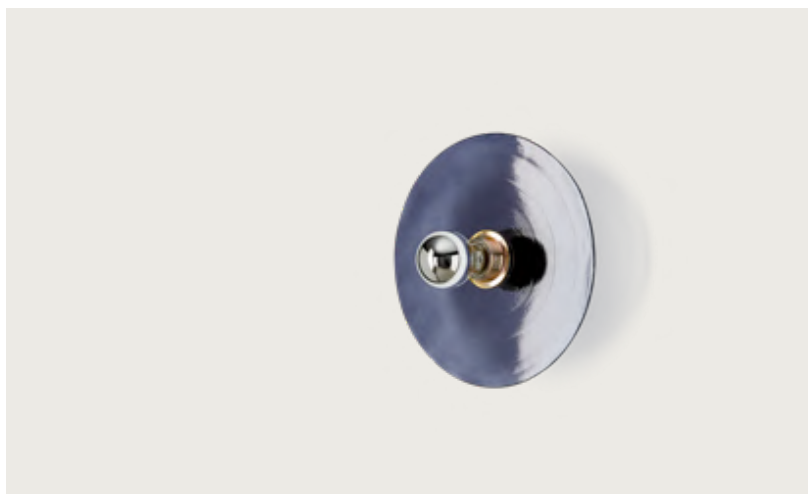

DESCRIPTION

MATERIALS

Steel / Alabaster

FINISHES

Steel:
Bright Gold
Chrome
White
Black

SPECIFICATIONS (UE)

E27 Max. 60W
(Not included)
220-240V, 50/60Hz
IP20, Class I

ENERGY LABEL

A ++

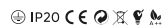

TECHNICAL

MATERIALES

Acero / Alabastro

ACABADOS

Acero:
Oro Brillo
Cromo
Blanco
Negro

ESPECIFICACIONES (UE)

E27 Max. 60W
(No incluida)
220-240 V, 50/60 Hz
IP20, Clase I

ETIQUETA ENERGÉTICA

A ++

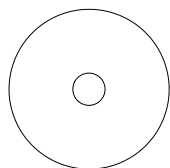

Ø150 / Ø250 / Ø350

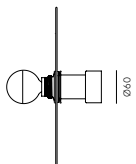

50 / 100 / 150 / 200 / 250

SPIDER 30cm: 233€ (+IVA) 52cm: 272€ (+IVA)

Wall lamp

A1053 + 1163

Designed by Fornasevi, 2013



DESCRIPTION

MATERIALS

Steel / Glass

FINISHES

Metal:
Shiny Gold
Chrome
White
Black

Glass:
Amber
Pink
Dark Blue
Turquoise
Brown

Image: Gold and amber

RECOMMENDED BULB

B038/GOLD

SPECIFICATIONS (UE)

E27 Max. 60W
(Not included)
220-240V, 50/60Hz
IP20, Class I

ENERGY LABEL

A ++



TECHNICAL

MATERIALES

Acero / Cristal

ACABADOS

Metal:
Oro Brillo
Cromo
Blanco
Negro

Cristal:
Ambar
Rosa
Azul Oscuro
Turquesa
Marrón

Imagen: Oro y ámbar

BOMBILLA RECOMENDADA

B038/ORO

ESPECIFICACIONES (UE)

E27 Max. 60W
(No incluida)
220-240 V, 50/60 Hz, IP20,
Clase I

ETIQUETA ENERGÉTICA

A ++

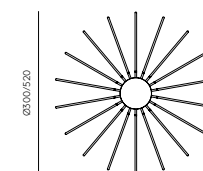

Ø100/150

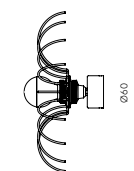

Ø40

147

LAOS 30cm: 212€ (+IVA)
50cm: 231€ (+IVA)

Wall lamp

A1053 + 1141

Designed by JF Sevilla, 2020



DESCRIPTION

MATERIALS

Steel / Natural Dried Grass

FINISHES

Metal: Shiny Gold / Chrome / White / Black

Wheel: Dried Grass

EACH PIECE SOLD SEPARATELY
Composition 3 pieces

AVAILABLE DIAMETERS
30 and 50 cm

RECOMMENDED BULBS
B035 (Ø95) B038 (Ø55)

ESPECIFICACIONES (UE)
E27 Max. 60W (Not included)
220-240 V, 50/60 Hz,
IP20, Class I

ENERGY LABEL

A ++

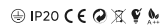

MATERIALES

Acero / Paja Natural

ACABADOS

Metal: Oro Brillo / Cromo / Blanco / Negro

Rueda: Paja Natural

SE VENDE POR SEPARADO
Composición de 3 piezas

DIÁMETROS DISPONIBLES
30 y 50 cm

BOMBILLAS RECOMENDADAS
B035 (Ø95) B038 (Ø55)

ESPECIFICACIONES (UE)
E27 Max. 60W (No incluida)
220-240 V, 50/60 Hz,
IP20, Clase I

ETIQUETA ENERGÉTICA

A ++

TECHNICAL

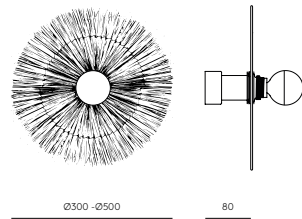

FLAT 30cm: 258€ (+IVA)
60cm : 364€ (+IVA)
90cm : 461€ (+IVA)

Wall lamp

A1053 + 1135

Designed by AC Studio, 2023

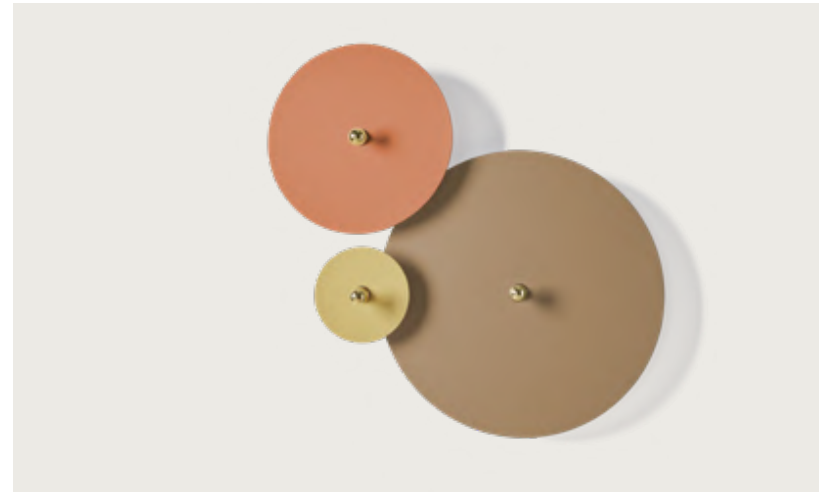

DESCRIPTION

MATERIALS

Steel / Textile

FINISHES

Metal: Shiny Gold / Chrome / White / Black

AVAILABLE DIAMETERS
30, 60 y 90 cm

ESPECIFICACIONES (UE)
E27 Max. 60W (bulb not included)
220-240 V, 50/60 Hz
IP20, Class I

ENERGY LABEL

A ++

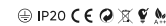

MATERIALES

Metal / Textil

ACABADOS

Metal: Oro Brillo / Cromo / Blanco / Negro

DIÁMETROS DISPONIBLES
30, 60 y 90 cm

ESPECIFICACIONES (UE)
E27 Max. 60W (Bombilla no incluida)
220-240 V, 50/60 Hz
IP20, Clase I

ETIQUETA ENERGÉTICA

A ++

TECHNICAL

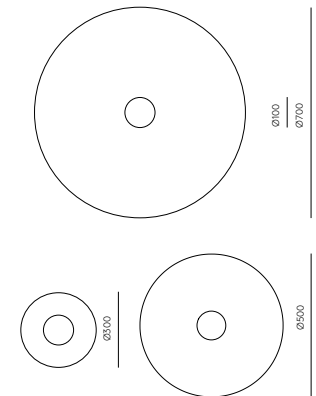



FLAT



TAN TAN

30cm: 354€ (+IVA)
 60cm : 422€ (+IVA)
 90cm : 552€ (+IVA)

Wall lamp

A1053 + 1125
 Designed by Fornasevi, 2018



DESCRIPTION

MATERIALS
 Steel / Rattan

FINISHES
Metal:
 Shiny Gold
 Chrome
 White
 Black
Wheel:
 Natural
 Black

BULBS
 B035 (Ø95) B038 (Ø55)

SPECIFICATIONS (UE)
 E27 Max. 60W (Not included)
 220-240 V, 50/60 Hz, IP20,
 Class I

ENERGY LABEL
 A ++

TECHNICAL

MATERIALES
 Acero / Ratán

ACABADOS
Metal:
 Oro Brillo
 Cromo
 Blanco
 Negro
Rueda:
 Natural
 Negro

BOMBILLAS
 B035 (Ø95) B038 (Ø55)

ESPECIFICACIONES (UE)
 E27 Max. 60W (No incluida)
 220-240 V, 50/60 Hz, IP20,
 Clase I

ETIQUETA ENERGÉTICA
 A ++

Ø300 / Ø600 / Ø900

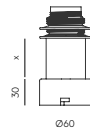
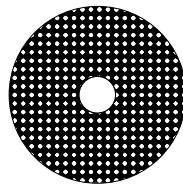

KASSY

20cm: 226€ (+IVA)
 30cm : 254€ (+IVA)

Wall lamp

A1053 + 1097
 Designed by Fornasevi, 2018

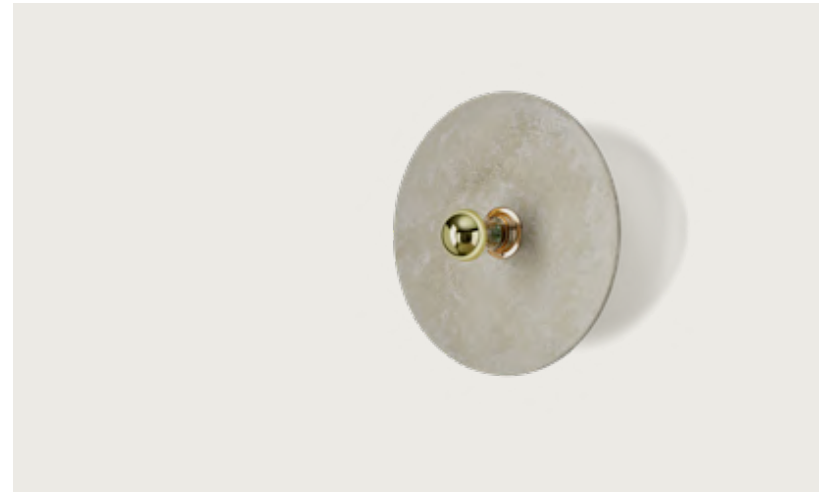

DESCRIPTION

MATERIALS
 Steel / Ceramic

FINISHES
Metal:
 Shiny Gold
 Chrome
 White
 Black

DISC DIMENSIONS
 200 - 300 MM

BULB IMAGE
 B038/GOLD

SPECIFICATIONS (UE)
 E27 Max. 60W (Not included)
 220-240 V, 50/60 Hz, IP20,
 Class I

ENERGY LABEL
 A ++

TECHNICAL

MATERIALES
 Acero / Cerámica

ACABADOS
Metal:
 Oro Brillo
 Cromo
 Blanco
 Negro

DIMENSIONES DISCO
 200 - 300 MM

BOMBILLA IMAGEN
 B038/ORO

ESPECIFICACIONES (UE)
 E27 Max. 60W (No incluida)
 220-240 V, 50/60 Hz, IP20,
 Clase I

ETIQUETA ENERGÉTICA
 A ++

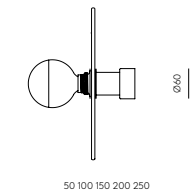
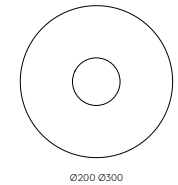

WAVE 349€ (+IVA)

Wall lamp

A1053 + 1094/30

Designed by Fornasevi, 2022

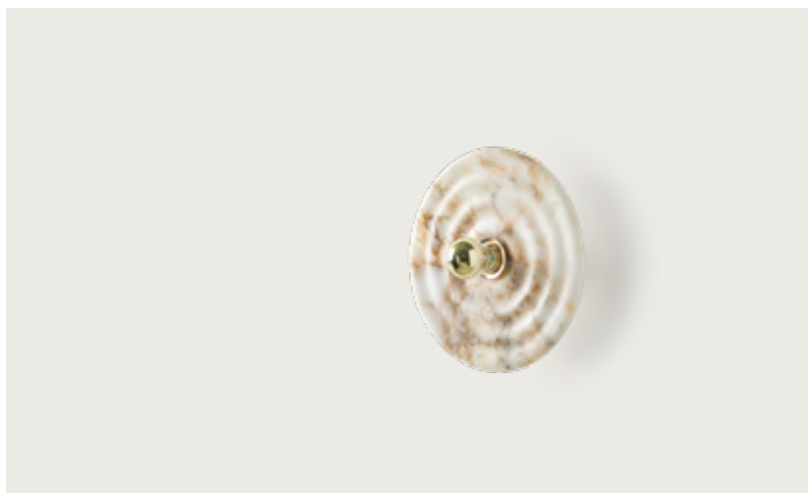

DESCRIPTION

MATERIALS

Steel / Alabaster

FINISHES

Steel:
Bright Gold
Chrome
White
Black

SPECIFICATIONS (UE)

E27 Max. 60W
(Not included)
220-240V, 50/60Hz
IP20, Class I

ENERGY LABEL

A++

⊕ IP20 CE   

TECHNICAL

MATERIALES

Acero / Alabastro

ACABADOS

Acero:
Oro Brillo
Cromo
Blanco
Negro

ESPECIFICACIONES (UE)

E27 Max. 60W
(No incluida)
220-240 V, 50/60 Hz
IP20, Clase I

ETIQUETA ENERGÉTICA

A++

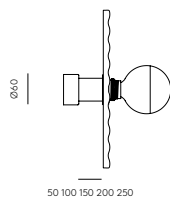
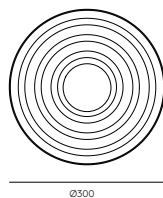

ALBA 25cm: 328€ (+IVA)
35cm : 424€ (+IVA)

Wall lamp

A1053 + 1096

Designed by JF Sevilla, 2019

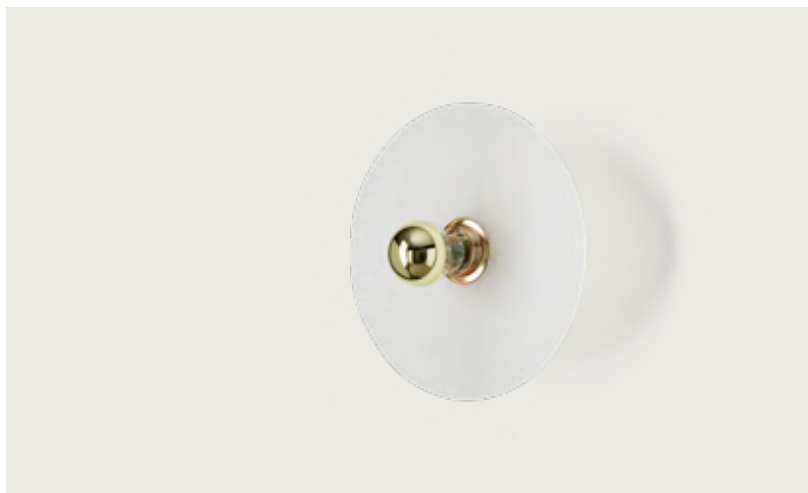

DESCRIPTION

MATERIALS

Steel / Alabaster

FINISHES

Metal:
Shiny Gold
Chrome
White
Black

DISC DIMENSIONS

250 - 350 MM

BULB IMAGE

B038/GOLD

SPECIFICATIONS (UE)

E27 Max. 60W (Not included)
220-240 V, 50/60 Hz, IP20,
Class I

ENERGY LABEL

A ++



MATERIALES

Acero / Alabastro

ACABADOS

Metal:
Oro Brillo
Cromo
Blanco
Negro

DIMENSIONES DISCO

250 - 350 MM

BOMBILLA IMAGEN

B038/ORO

ESPECIFICACIONES (UE)

E27 Max. 60W (Not included)
220-240 V, 50/60 Hz, IP20,
Class I

ETIQUETA ENERGÉTICA

A ++

TECHNICAL

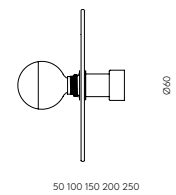
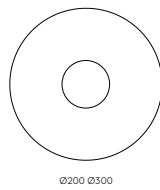

LINE 254€ (+IVA)

Wall lamp

A1053 + 1089

Designed by Fornasevi, 2018

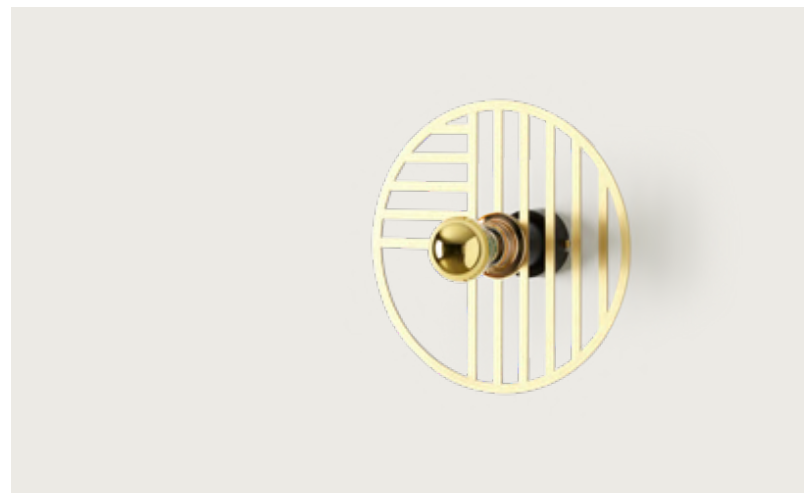

DESCRIPTION

MATERIALS

Steel / Ceramic

FINISHES

Metal:
Shiny Gold
Chrome
White
Black

DISC DIMENSIONS

200 - 300 MM

BULB IMAGE

B038/GOLD

SPECIFICATIONS (UE)

E27 Max. 60W (Not included)
220-240 V, 50/60 Hz, IP20,
Class I

ENERGY LABEL

A ++

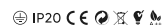

MATERIALES

Acero / Cerámica

ACABADOS

Metal:
Oro Brillo
Cromo
Blanco
Negro

DIMENSIONES DISCO

200 - 300 MM

BOMBILLA IMAGEN

B038/ORO

ESPECIFICACIONES (UE)

E27 Max. 60W (No incluido)
220-240 V, 50/60 Hz, IP20,
Class I

ETIQUETA ENERGÉTICA

A ++

TECHNICAL

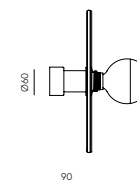

HABAN

25cm: 216€ (+IVA)
35cm : 240€ (+IVA)

Wall lamp

A1053 + 1088

Designed by JF Sevilla, 2019



DESCRIPTION

MATERIALS

Steel

FINISHES

Support:
Black
Gold
Chrome

Fans:

Image colors:
Pale pink, Make Up, White,
Mustard, Mexico Blue

Color palette on pg. 432

BULB IMAGE

B038/ORO (reflecting)
B033/COB (opal)

SPECIFICATIONS (UE)

E27 Max. 60W (Bulb not included)
220-240 V, 50/60 Hz
IP20, Class I

ENERGY LABEL

A ++

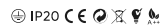

MATERIALES

Acero

ACABADOS

Soporte:
Negro
Oro
Cromo

Abanicos:

Colores en imagen: Rosa palo,
Maquillaje, Blanco, Mostaza y
Azul México

Paleta de colores en pág. 432

BOMBILLA IMAGEN

B038/ORO (espejada)
B033/COB (opal)

ESPECIFICACIONES (UE)

E27 Max. 60W (Bombilla no
incluida) 220-240 V, 50/60 Hz
IP20, Clase I

ETIQUETA ENERGÉTICA

A ++

TECHNICAL

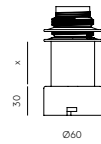
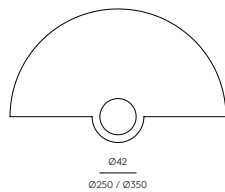

GHABAN

60cm: 434€ (+IVA)
90cm : 550€ (+IVA)
110cm : 665€ (+IVA)

Wall lamp

A1053 + R1086/1086

Designed by Fornasevi, 2022

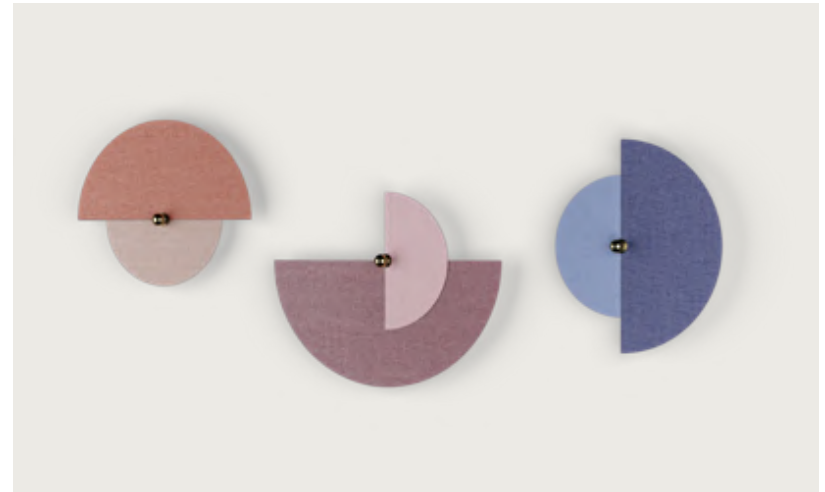

DESCRIPTION

MATERIALS

Steel / Fabric / Rattan

FINISHES

Steel:
Bright Gold
Chrome
White
Black

Fabrics:

Check color palette

SPECIFICATIONS (UE)

E27 Max. 60W
(Not included)
220-240V, 50/60Hz
IP20, Class I

ENERGY LABEL

A ++

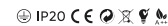

MATERIALES

Acero / Textil / Ratán

ACABADOS

Acero:
Oro Brillo
Cromo
Blanco
Negro

Textil:

Consultar paleta de colores

ESPECIFICACIONES (UE)

E27 Max. 60W
(No incluida)
220-240 V, 50/60 Hz
IP20, Clase I

ETIQUETA ENERGÉTICA

A ++

TECHNICAL

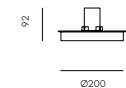
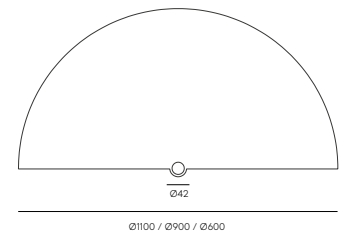

GHABAN

La Habana, Cuba





Accesorios

CATÁLOGO DE ACCESORIOS ACCESSORIES CATALOGUE

A continuación se ofrece nuestro catálogo de accesorios recomendados para su uso en nuestras luminarias.

Below is our catalog of recommended accessories for use in our lamps.

Para más información sobre pantallas y accesorios, por favor consulte nuestra tarifa a partir de la página 57.

For more information on screens and accessories, please see our price list starting on page 57



1038

MATERIAL
METAL

FINISH
GOLD
CHROME
BLACK
WHITE
MATT BRASS

SIZES
Ø150
Ø250
Ø350



R1052

MATERIAL
METAL

FINISH
GOLD
CHROME
BLACK
WHITE

SIZES
Ø300
Ø600
Ø900

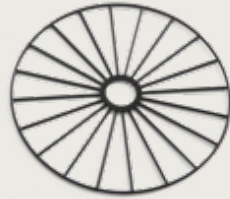

1096

MATERIAL
ALABASTER

FINISH
NATURAL

SIZES
Ø250
Ø350



1097

MATERIAL
CERAMIC

FINISH
CERAMIC

SIZES
Ø200
Ø300



1088

MATERIAL
METAL

FINISH
WHITE
BLACK
COLOR,
CONSULT US

SIZES
Ø250
Ø350



1089

MATERIAL
METAL

FINISH
GOLD
CHROME
BLACK
WHITE
MATT BRASS

SIZE
Ø250



1125

MATERIAL
RATTAN

FINISH
NATURAL
BLACK

SIZES
Ø300
Ø600
Ø900



1132

MATERIAL
RESIN

FINISH
WHITE
BLACK
COLOR,
CONSULT US

SIZE
Ø500

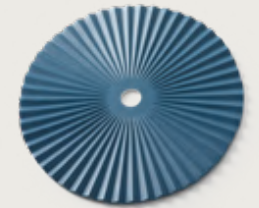

1093/50

MATERIAL
RESIN

FINISH
WHITE
SEE COLOUR
PALLETTE

SIZES
Ø500



1094/30

MATERIAL
ALABASTER

FINISH
NATURAL

SIZES
Ø300



1141

MATERIAL
DRIED GRASS

SIZE
Ø500
Ø500



1143 / 1144

MATERIAL
BAMBOO

FINISH
NATURAL

SIZE
Ø400
Ø500



1160

MATERIAL
NATURAL FIBER

FINISH
BLACK

SIZE
Ø300
Ø600



1163

MATERIAL
METAL WIRE

FINISH
GOLD
CHROME
MATT BLACK
MATT WHITE

SIZES
Ø300
Ø520



C1010

MATERIAL
METAL

FINISH
BLACK

SIZE
3M CABLE

BULB
E27



C1010

MATERIAL
METAL

FINISH
GOLD

SIZE
3M CABLE

BULB
E27



1215

DESCRIPCIÓN
Soporte para fijación de colgantes a pared

DESCRIPTION
Support for wall hanging fixing

SIZE
250MM



1223

MATERIAL
GLASS

FINISH
PINK
TURQUOISE
DARK BLUE
AMBER
BROWN

SIZE
Ø250



C1011

MATERIAL
METAL

FINISH
BRONZE

SIZE
3M CABLE

BULB
E27



C1012

MATERIAL
METAL

FINISH
BLACK

SIZE
3M CABLE

BULB
E27



1225

MATERIAL
GLASS

FINISH
TEXTURED

SIZE
Ø300
Ø500



1289

MATERIAL
ALABASTER
METAL

FINISH
GOLD
CHROME
BLACK
WHITE
ALABASTER

SIZE
Ø150
Ø250
Ø350



A1053

MATERIAL
Metal

ACABADOS
Oro Brillo
Cromo
Blanco
Negro

DIMENSIONES
(X)

5 cm
10 cm
15 cm
20 cm
25 cm

BOMBILLA E27

MATERIAL
Metal

FINISH
Shinny Gold
Chrome
White
Black

DIMENSIONES
(X)

5 cm
10 cm
15 cm
20 cm
25 cm

BULB E27

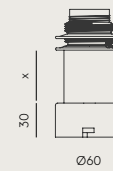

Finishes

COLORES DE CRISTALES COLOR GLASS

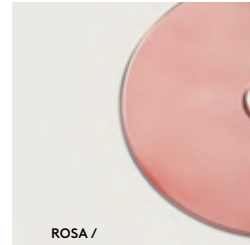

ROSA /
PINK



ÁMBAR /
AMBER

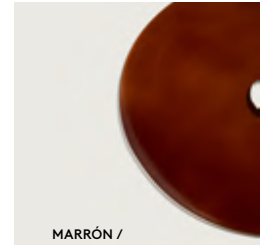

MARRÓN /
BROWN



TURQUESA /
TURQUOISE



AZUL OSCURO /
DARK BLUE

PALETA DE COLOR MÁRMOL MARBLE COLOR PALETTE

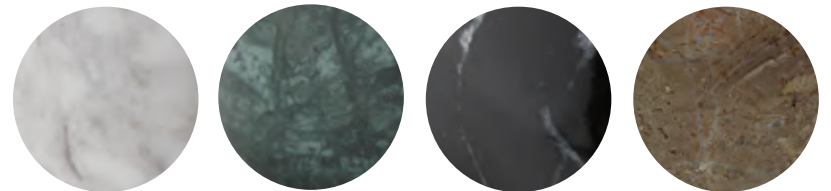

PALETA DE COLOR CERÁMICA, VIDRIO Y METAL COLOR PALETTE CERAMICS, GLASS & METAL

Los colores de la paleta son aproximados.
Consultar los códigos en la carta RAL o NCS.

The colors in the palette are approximate.
Consult the RAL or NCS references.

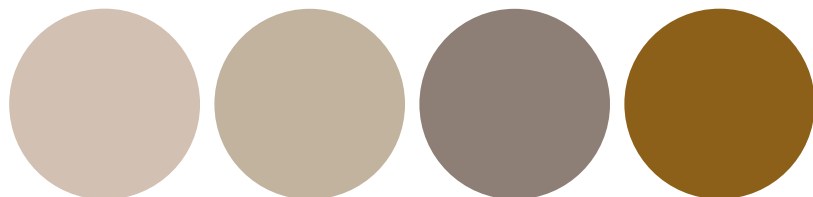

NUDE
NCS S2010Y50R

SILHOUETTE
NCS S2809Y01R

VINTAGE BROWN /
MARRÓN VINTAGE
NCS S5805Y46R

HONEY /
MIEL
NCS S5040Y10R

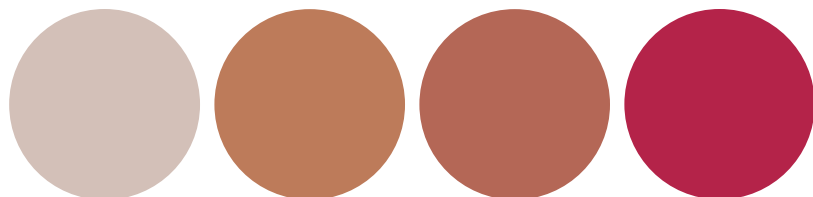

TAUPE /
TOPO
NCS 2005Y60R

NATURAL CLAY
NCS S3932Y40R

TERRACOTTA
NCS S4030Y70R

VIVA MAGENTE
NCS S2060R10B

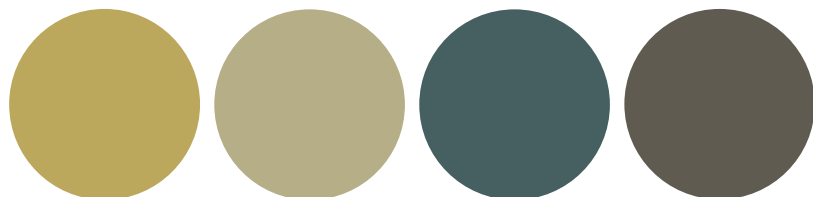

BANANA GREEN
NCS S2030G90Y

SAND BROWN /
ARENA MARRÓN
NCS S3020G50Y

HUNT GREEN /
VERDE HUNT
NCS S6530B50G

GREEN LEAF /
VERDE HOJA
NCS S7005G80Y

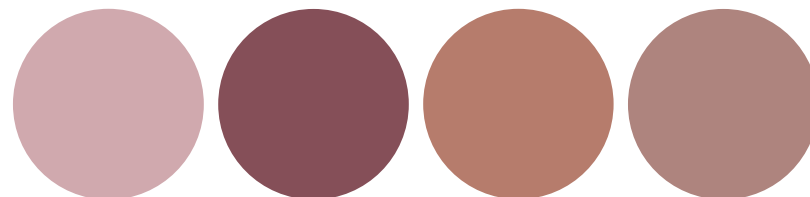

ROSA PALO /
PALE PINK
NCS S2010R10B

MINERAL RED /
MINERAL ROJO
NCS S5030R10B

MAQUILLAJE /
MAKE UP
NCS S020Y70R

DESERT RED /
ROJO DESIERTO
NCS S3020Y90R

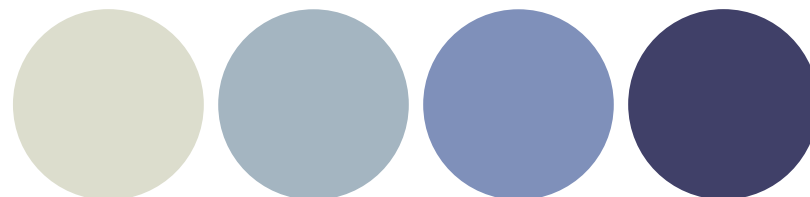

MOLA GREEN /
VERDE MOLE
NCS S2206G70Y

MEXICO BLUE /
AXUL MÉXICO
NCS S3010B10G

OPAL VIOLET /
VIOLETA OPALINO
NCS S3030R70B

PETROL BLUE /
AZUL SOMBRÍO
NCS S6030R60B

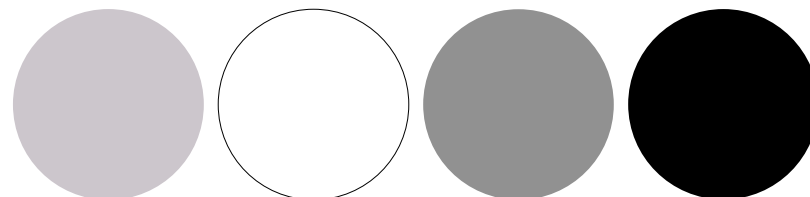

LIGHT VIOLET/
VIOLETA CLARO
NCS S1510R40B

BLANCO /
WHITE

GRIS CENIZA /
ASH GREY
NCS S4000N

NEGRO /
BLACK

Information

INFORMACIÓN GENERAL GENERAL INFORMATION

Las descripciones y medidas de los productos del presente catálogo son orientativas, pudiendo por tanto ser modificadas, a fin de mejorar las características técnicas o de diseño. La empresa se reserva el derecho de anular o modificar cualquier modelo sin previo aviso. Todos los modelos cumplen las normas exigidas por la CE para iluminación de uso doméstico y sus características vienen determinadas por las clase 1 y la clase 2. Los acabados y las especificaciones técnicas corresponden a los productos que se suministran en Europa, pudiendo estos variar en otros mercados. Para una buena conservación de las lámparas, no usar bombillas de potencia superior a las recomendadas y limpiar solamente con un paño seco. No usar limpiametales ya que dañan los barnices protectores que garantizan la duración del acabado.

The descriptions and dimensions of the items in this catalogue are indicative and may be modified for the purpose of technical or design improvements. We reserve the right to cancel or change all models without prior notice. All items meet the CE, Class 1 and class 2 safety regulations for home lighting appliances. The finishings and technical specifications listed here are for the European market and may vary elsewhere. Do not use stronger bulbs that recommended, and always clean lamps with a soft dry cloth. Metal polish will damage the protective finishings.

IMÁGENES IMAGES

Algunas imágenes mostradas en este catálogo corresponden a renders y son susceptibles de tener ligeros cambios en medidas y acabados respecto al producto final.

Some images shown in this catalogue correspond to renders and are likely to have slight changes in measurements and finishes with respect to the final product.

ICONOS ICONS

-  Tipo I
Class I
-  Tipo II
Class II
-  Tipo III
Class III
-  Reciclabre
Recyclable
-  Aparato electrónico no reciclable
Non-recyclable Electronic device
-  Certificación Europea
European Certification
-  Ajustable
Adjustable
-  Ajustable izquierda - derecha
Adjustable left - right
-  Ajustable arriba - abajo
Adjustable up - down
-  Bombilla incluida
Bulb included
-  Bombilla no incluida
Bulb not included
-  Bombilla no reciclable
Non-recyclable bulb
-  Clase energética
Energy class
-  Regulador de intensidad
Dimmer
-  Se enciende al tocar
Touch active
- IP20** Protección frente a sólidos de tamaño superior a 12mm y ninguna protección de líquidos
Protection against solids larger than 12mm and no protection from liquids

CONDICIONES GENERALES

1. PRECIOS

- 1.1. Los indicados en esta tarifa, son sin IVA ni recargo de equivalencia que proceda.
- 1.2. Los precios de las lámparas no incluyen bombillas o pantallas, salvo que este indicado lo contrario.
- 1.3. Esta tarifa de precios anula todas las anteriores.

2. PEDIDOS

- 2.1. Es imprescindible enviar los pedidos o modificaciones por correo electrónico, no se aceptarán pedidos por teléfono o modificaciones.

3. CONDICIONES DE PAGO

- 3.1. La forma de pago general es pago anticipado. En el caso de cambio de pago a giro o similar, el cliente deberá remitir con su firma y sello el formulario de domiciliación SEPA.
- 3.2. En las cuentas de los clientes con riesgo comercial aprobado, las condiciones particulares de pago, se acordarán individualmente con el responsable comercial de cada zona, y serán aprobadas por el departamento financiero.
- 3.2.1 En ningún caso excederán los siguientes límites:
Vencimiento 45 días con giro bancario domiciliado se aceptan días de pago fijos a propuesta del cliente. Para aquellos clientes que no puedan aceptar cargos por GIRO bancario, la forma de pago máxima será transferencia o pagaré a 30 días. Se aceptan días de pagos fijos a propuesta del cliente.
- 3.3. Los pedidos de proyectos que por su volumen deban ser fabricados, se deberá abonar un 30% o 50% del valor del pedido, como confirmación e inicio de producción.
- 3.4. El cliente no está autorizado a deducir, de los vencimientos, ningún importe en concepto de reclamación. A menos que les hayamos autorizado a ello por escrito.
- 3.5. En el caso de impagos, AROMAS se reserva el derecho de no aceptar o enviar pedidos hasta desbloquear la cuenta nuevamente.

4. CONDICIONES DE TRANSPORTE

- 4.1. Los pedidos superiores a 350€ netos se enviarán a portes pagados a territorio nacional. Para pedidos de importes inferiores, los portes se cargarán en factura con un mínimo de 9€ o el 7% del valor de la mercancía. En el caso de Portugal, los portes pagados son por pedidos superiores a 600€ netos. Para pedidos de importes inferiores, los portes son de 30€.
- 4.2. Los portes de los pedidos solicitados por transporte urgente, serán a cargo del cliente, previa aceptación del mismo, sea cual sea su importe.

5. INCIDENCIAS DEL TRANSPORTE

- 5.1. Si se produce alguna anomalía, daños visibles, embalaje dañado o se intuyen daños ocultos, deberá hacerse constar por escrito en el albarán del transporte, en el momento de la recepción de la mercancía. Además, se debe notificar a Aromas del Campo, en las 24h posteriores a la entrega, vía correo electrónico, incluyendo copia del albarán y fotos.

6. REPARACIONES

- 6.1. El presupuesto de reparación se realizará una vez la lámpara está en fábrica.
- 6.2. Los portes de las mercancías que se desea reparar serán a cargo del cliente.
- 6.3. Las lámparas que hace más de un año que están descatalogadas, se puede solicitar el envío con cargo de recambio de las piezas en el caso de que estén disponibles.

7. DEVOLUCIONES

- 7.1. Solo se admiten devoluciones causadas por incidencia de producto y que haya sido autorizado previamente por Aromas del Campo.
- 7.2. Las devoluciones deben enviarse con su embalaje original, de lo contrario nuestro almacén rechazará la entrada de la mercancía.
- 7.3. Una vez verificado el producto por nuestro dpto. de calidad, en el caso de no conformidad, se cargará al cliente los gastos de reenvío y los recargos que se estimen oportunos. Pudiendo aplicar hasta un 15% de penalización en concepto de reembolso.

8. VENTA ONLINE

- 8.1. Para poder ser distribuidor autorizado a vender y publicar luminarias de AROMAS DEL CAMPO a través del sitio web, es imprescindible haber firmado el acuerdo de venta Online.
- 8.2. Cualquier producto de AROMAS DEL CAMPO que se desee poner en soporte WEB debe cumplir unas condiciones de inserción.

9. CONDICIONES GENERALES

- 9.1. AROMAS DEL CAMPO se reserva el derecho a efectuar cualquier modificación y anulación de los productos del catálogo y la tarifa vigente sin preaviso alguno.
- 9.2. El cliente declara conocer y aceptar las condiciones de venta aquí descritas.

GENERAL CONDITIONS

1. PRICES

- 1.1. The given prices are the suggested retail prices without VAT.
- 1.2. The pricing do not include bulbs or shades except when mentioned.
- 1.3. This Price list nullify any other Price list.

2. ORDERS

- 2.1. All orders must be sent via email with reference codes, names, colors and if shades and bulbs are needed.

3. PAYMENT TERMS

- 3.1. All orders must be paid in advance by wire transfer with proforma number in description..
- 3.2. In case of orders that require customized products or for projects orders, the company will require total payment or 50% advanced payment.
- 3.3. Payment delays for holidays or festivities will not be accepted.
- 3.4. The delivery date is determined by the circumstances from the date in which the proforma is paid.
- 3.5. The client is not authorized to claim any incident if it is not in writing.
- 3.6. The company reserves right to deny orders if the client does not comply with payment commitments.

4. TRANSPORTATION

- 4.1. Transportation costs are calculated according to order and destination.
- 4.2. If client requires urgent shipment, additional costs will be applied.

5. CLAIMS

- 5.1. Any visible damage in packaging must be notified to shipping company upon receipt.
- 5.2. Claims will be accepted 5 working days after receiving order.
- 5.3. Claims must be sent via email to account manager with photos and description If the above points are not met, the claim can be disqualified.
- 5.4. Claims will be accepted 5 working days after receiving order.
- 5.5. Damage claims are not included except if proved to be manufacturing flaw by AROMAS DEL CAMPO.

6. REPAIRS

- 6.1. If a third party wishes to repair a product before being returned to factory, it must be authorized by AROMAS DEL CAMPO.
- 6.2. The product must be packed correctly and in the original box.
- 6.3. Once the product is received in factory, an approximate price to repair will be issued.
- 6.4. Transportation costs will be covered by client.
- 6.5. In case the lamp has been discontinued, it can be repaired if the company has spare parts.
- 6.6. All repairs will be charged.

7. RETURNS

- 7.1. All returns must have approval by company, including claim cases.
- 7.2. For defective products, shipping company authorized by AROMAS will pick up correctly packed box.
- 7.3. We reserve right to charge additional repair costs if the returned package is damaged.
- 7.3. After product examination concludes that complaint was not justified, the company reserves right to charge extras.

8. WEB

- 8.1. In order to sell or publish any AROMAS DEL CAMPO product on the internet, an agreement must be signed.
- 8.2. The display of photographs of products or similar to AROMAS DEL CAMPO in websites must have specified authorization by the company.

9. GENERAL CONDITIONS

- 9.1. AROMAS DEL CAMPO reserves right to modify, without notice, prices in current catalogue and discontinue products.
- 9.2. Printing errors reserved.
- 9.3. Delivery dates are not complaining, AROMAS DEL CAMPO will attempt to fulfill them, however, cannot be held accountable under any case.
- 9.4. Discount rates can be modified at any moment.
- 9.5. Services offered by any company related to AROMAS DEL CAMPO distribution of products; like replacement of lamps, components, shipping of tester products, are covered by AROMAS DEL CAMPO.
- 9.6. All products are property of AROMAS DEL CAMPO until complete claim settlement.
- 9.7. Client accepts the conditions mentioned in this document.
- 9.8. AROMAS DEL CAMPO reserves right to declare a client account null if commercial agreement terms are not met.

COFER STUDIO

Quivira, Los Cabos. México

CONTACT

T. +52 624 192 3366
M. sales@coferstudio.com
W. coferstudio.com

DIVISA: EUR + IVA
TIPO DE CAMBIO BANORTE
COFER STUDIO REPRESENTANTE EXCLUSIVO EN MÉXICO

PROJECT DIRECTION

ángelsegurafoto<

CONCEPT & ART DIRECTION

PerezOchando

PHOTOGRAPHY

ángelsegurafoto<

PRINTED BY

Libecrom

© AROMAS DEL CAMPO SL 2023

